

Foster 

Foster 



fosterspa.com

Il mondo di Foster
un mondo migliore per le future generazioni



18	PVD
92	Lavelli sopratop
204	Lavelli sottotop
286	Complementi
306	Miscelatori
342	Canali attrezzati
362	Piani induzione
394	Piani gas
434	Forni
456	Cappe
478	Lavastoviglie
482	Top inox



Foster

RICERCA, DESIGN e TECNOLOGIA tutte in un segno, il marchio Foster.

Il desiderio di trovare sempre nuove soluzioni per migliorare la qualità della vita in cucina è il motore della nostra ricerca, la ragione della nostra soddisfazione.

Abbiamo stabilito importanti traguardi nello sviluppo degli elettrodomestici e con lo stesso entusiasmo, ogni giorno, ci confrontiamo con le idee dei più quotati fabbricanti di cucine italiani e del mondo.

Questa è la filosofia Foster: standard qualitativi d'eccellenza, alta maestria nella lavorazione dei materiali, soluzioni sempre innovative interpretate con il gusto e lo stile che ci contraddistinguono.

Foster e il territorio

ispirati da
Arte e Cultura



Fondata nel 1973, Foster è un'azienda italiana con quattro stabilimenti produttivi che opera in più di 50 paesi nel mondo. Un'organizzazione integrata con sede nello storico Palazzo Terranova di Brescello, piccolo borgo famoso per i film di Don Camillo e Peppone e simbolo dell'operosità della provincia del Nord Italia.

Palazzo Terranova non è solo la sede, è l'espressione dell'amore che Foster nutre per l'arte.

È il 1988 quando Foster stabilisce qui la propria sede, dopo l'intervento di recupero conservativo dell'ex convento francescano del '600. Il restauro ha restituito splendore ai prestigiosi affreschi ed ha portato alla luce antichi reperti storici.

Palazzo Terranova è un patrimonio culturale che l'azienda ha voluto restituire alla comunità in tutta la sua storia, bellezza e magnificenza. Foster è stata tra le prime aziende italiane ad aderire ai progetti per la salvaguardia e tutela del territorio ed il palazzo è oggi sotto la tutela della Soprintendenza per i Beni Architettonici e Paesaggistici



Foost



...ricerca

Ogni prodotto Foster è frutto di una profonda ricerca e di un costante processo di innovazione. Lavoriamo instancabilmente per portare avanti la tecnologia dell'acciaio inossidabile, utilizzando materiali di alta qualità come l'AISI 304 e l'AISI 316.



...design

Ogni elettrodomestico Foster è un'opera d'arte, creata con una cura meticolosa per i dettagli.

L'acciaio inossidabile, con la sua lucentezza senza tempo, si sposa perfettamente con qualsiasi stile di cucina, conferendo un tocco di eleganza e sofisticazione ad ogni ambiente.

ter



...tecnologia

Foster non si ferma solo all'estetica. Ogni prodotto è progettato per migliorare la tua esperienza culinaria. I nostri elettrodomestici sono dotati di funzionalità all'avanguardia, garantendo prestazioni impeccabili e facilità d'uso. La cucina diventa così un luogo in cui la creatività si combina con la massima efficienza. Benvenuti nel mondo Foster: Ricerca, Design e Tecnologia.

Foster e l'acciaio

una storia
di eccellenza



Da oltre mezzo secolo, Foster ha trasmesso la sua passione e dedizione nell'arte di modellare l'acciaio inossidabile AISI 304 e AISI 316, cuore e anima delle nostre creazioni.

Oltre la Materia Prima. Il nostro know-how non si ferma alla selezione della materia prima: Ogni passaggio del processo di lavorazione, dall'assemblaggio alle finiture, è frutto di anni di esperienza nell'arte di modellare l'acciaio con l'obiettivo di raggiungere la perfezione in ogni dettaglio. L'uso sapiente dell'AISI 304 e dell'AISI 316 è la nostra firma, la garanzia che ogni prodotto Foster è una combinazione straordinaria di bellezza e funzionalità.

Benvenuti nel mondo di Foster, dove l'acciaio diventa una storia d'eccellenza.

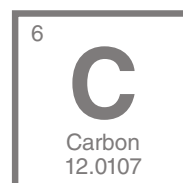
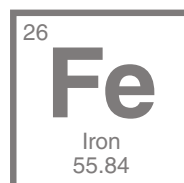



AISI 304 - L'Eccellenza Standard:

Il nostro profondo know-how nell'utilizzo dell'acciaio inossidabile AISI 304 è il segreto del nostro successo. Questo materiale, con il suo contenuto di cromo e nichel, è sinonimo di resistenza alla corrosione, durabilità e un'elevata tolleranza alle temperature estreme. Conosciuto anche come acciaio inox 18-10 (18% cromo e 10% nichel), l'AISI 304 è il nostro punto di partenza per creare prodotti che sono robusti, durevoli e privi di porosità. La superficie liscia e igienica dell'acciaio AISI 304 è facile da pulire e mantiene il suo splendore nel corso degli anni.

AISI 316 - La Soluzione per le Sfide Estreme:

L'utilizzo dell'acciaio AISI 316, noto per la sua eccezionale resistenza alla corrosione in ambienti estremi. Originariamente sviluppato per il settore nautico, l'AISI 316 è in grado di resistere alla salsedine, ai detersivi aggressivi e agli acidi degli alimenti. Questo materiale straordinario trova applicazione in una linea completa di prodotti Foster adatti agli ambienti più ostili e alle sfide più impegnative.



Acciaio inox

una scelta ecologica
senza tempo



**AISI
304**

L'utilizzo di acciaio **304** e **316** offre innumerevoli vantaggi, a partire dalla resistenza e durabilità che fanno dell'acciaio inox il materiale resistente per eccellenza.

**AISI
316**

La sua facilità di pulizia che consente di utilizzare meno acqua e meno prodotti chimici e la possibilità di essere riciclato innumerevoli volte rendono l'acciaio inox un materiale davvero ecosostenibile e vicino all'ambiente.

Riciclabile al 100%

Alta igienicità

Privo di emissioni tossiche

Inalterabile nel tempo

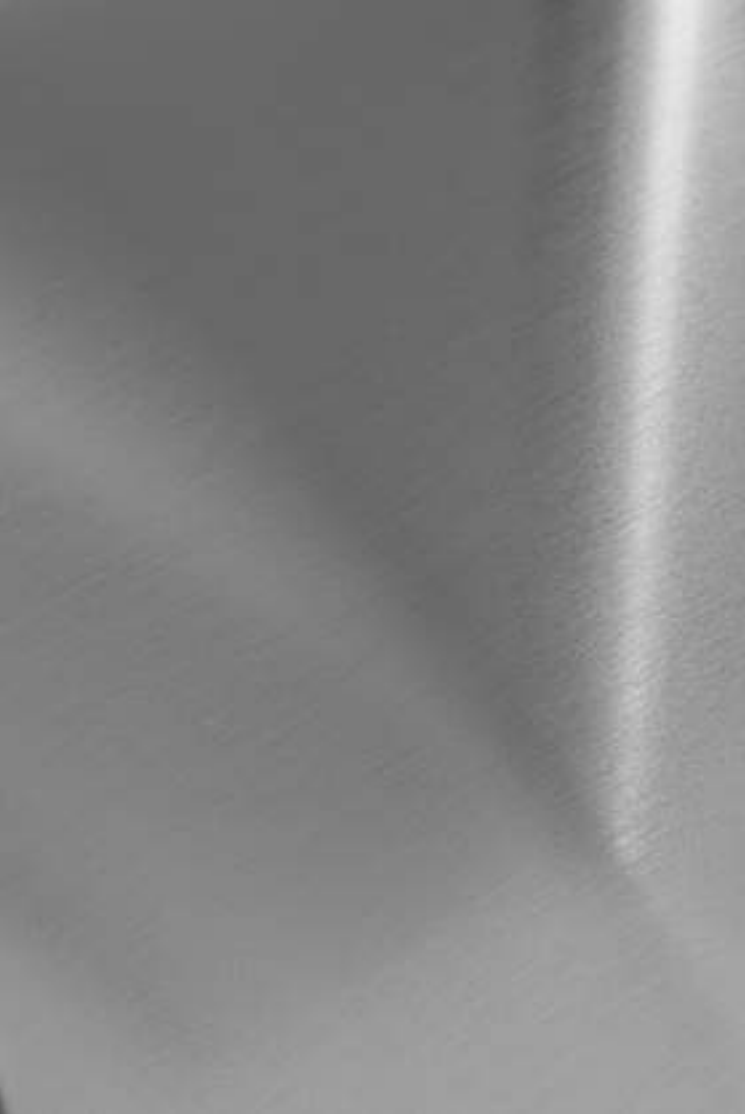

Finitura Satinata

L'acciaio inox **satinato** Foster è realizzato utilizzando speciali spazzole in fibra vegetale che donano una finitura brillante con ridotta rugosità superficiale. L'attenzione durante il processo di lavorazione e le speciali spazzole in fibra vegetale consentono una maggior facilità di pulizia dell'acciaio.



Finitura Vintage

L'acciaio inox **vintage** Foster è una finitura speciale ottenuta mediante una spazzolatura manuale che non teme nè graffi nè scalfiture.

La spazzolatura asimmetrica made in Foster, ottenuta con metodi totalmente artigianali, riproduce i tipici segni del tempo donando all'acciaio un tocco retrò.

Oltre l'incasso...

come e dove vuoi tu

Le modalità di incasso nei piani di lavoro sono sempre più differenziate e personalizzate.

Foster è stata la prima produttrice di lavelli ad impegnarsi nei nuovi sistemi di inserimento e oggi vanta una notevole esperienza e la più completa gamma disponibile sul mercato di modelli con inserimento a filo, semifilo e sottotop.



STD

Standard

Tipo di incasso tradizionale con il bordo che sporge di 8 mm sul piano di lavoro.



Q4

Q4

Incasso con profilo squadrato ed una minima sporgenza dal piano (4 mm). Soluzione perfetta per gli abbinamenti con i piani in vetroceramica (induzione).



SF

Semifilo

Bordo inclinato che sporge solo 3 mm sul top; si caratterizza per il connubio fra eleganza e facilità di installazione.



FT

SPT

Filotop

Si inserisce in un alloggiamento di un millimetro e risulta perfettamente a filo con il piano di lavoro. In alternativa, può essere installato in appoggio al top.



ST

Sottotop

Soluzione elegante ed attuale, è l'installazione del lavello sotto il piano di lavoro.



BR

Bordo ribassato

Bordo inclinato che sporge 4mm sul top; si caratterizza per la facilità di installazione, bordo e squadrette sono un unico corpo.



PB

Phantom Base

È l'innovativo fondo vasca in acciaio inox in grado di integrarsi perfettamente in lavelli costruiti da lastra.



Guida alla lettura del listino

2
Base 80



In dotazione: **2 griglie Black Milanello** (8100 602)

Accessori opzionali a pag. 286 **4**

3 1040 051 dx
1040 052 sx

1 FT incasso FT: vedi sito web
SPT incasso SPT: 789 x 503

- Acciaio AISI 304 satinato
- Dimensioni: **806 x 520** - 1 vasca: **430 x 374**
- Piletta automatica Space Push (PP) 3 ½"
- Possibilità fori aggiuntivi
- Sistema a 3 invasi

1 Tipologie d'incasso

Molti lavelli Foster sono disponibili in più versioni di incasso che possono presentare dimensioni leggermente diverse tra di loro. Raccomandiamo pertanto di fare riferimento alle specifiche riportate a fianco di ciascuna versione. Sotto al disegno è sempre indicato a quale tipo di incasso si riferiscono le quote.

3 Lavelli destri, sinistri e reversibili

La doppia codifica del singolo modello indica la disponibilità di versione destra e sinistra. Per versione destra (dx) si intende con vasca/e a destra (o vasca maggiore nei modelli senza gocciolatoio). Le versioni sinistre sono contrassegnate con sx. Il codice unico indica che il lavello è reversibile, o disponibile solo come rappresentato in foto e disegno.

4 Accessori specificati per ogni serie

Attenta a coniugare estetica e funzionalità, da sempre Foster pone particolare attenzione agli accessori dei propri prodotti. Anche nel presente listino si è voluto dare importanza alle dotazioni opzionali, riportate alla fine di ogni serie e riferite ai singoli modelli, per identificare con facilità i corretti abbinamenti.

accessori



P4

Tagliere Twin
31,7x42,5 cm
8644 003

4350 001 L1 L3 L4 N2 N3 O2 P1 P2

S T T2 Z Z2

2 Basi

Per base si intende il più piccolo modulo standard di cucina componibile nel quale può essere inserito il lavello. In alcuni casi è riportata una doppia misura:

(β) per inserimento in top di spessore di almeno 40 mm, considerare la misura minore, indicata tra parentesi.

(es. pag. 128);

(T) per inserimento a inizio/fine composizione, considerare la misura maggiore, indicata tra parentesi.

Si rimanda alla conoscenza dei produttori di cucine per inserimenti particolari che richiedono lavorazioni sui mobili.

Nota: le misure delle basi indicate si riferiscono agli ingombri delle vasche e non dei sistemi di fissaggio, che possono cambiare nelle diverse installazioni.

Si rimanda alla conoscenza dei produttori di cucine per inserimenti particolari che richiedono lavorazioni sui mobili.

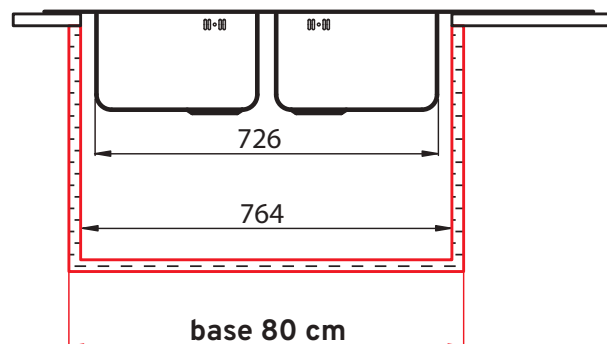

Fori miscelatore

Nei disegni, riportati alla fine di ogni serie, sono indicati con tratto continuo i fori rubinetto in dotazione standard. Con tratteggio sottile le posizioni per eventuali altri fori su richiesta per consentire l'immediato inserimento del comando della piletta automatica o di un eventuale dispenser. Per alcuni modelli, la personalizzazione con fori aggiuntivi è eseguita con sovrapprezzo.

Foster e l'acciaio

il PVD

Physical Vapor Deposition



L'acciaio prende colore.

Il trattamento dell'acciaio PVD, acronimo di Physical Vapor Deposition, è un processo fisico avanzato che consente di modificare la superficie dell'acciaio inossidabile per ottenere colorazioni uniche e resistenza superficiale superiore.

Nel processo PVD, l'acciaio inossidabile viene posto in una camera sottovuoto, dove metalli selezionati vengono riscaldati fino a diventare vapori. Questi vapori metallici vengono poi depositati sulla superficie dell'acciaio inossidabile in modo controllato mediante una forte scarica elettrica. Successivamente, i vapori metallici vengono arricchiti con speciali gas di processo, che consentono agli ioni metallici di aderire fisicamente alla superficie dell'acciaio inossidabile.

Il risultato è una superficie colorata, che può variare da tonalità come il Grigio canna di fucile, l'Oro al Rame. Questo processo conferisce all'acciaio inossidabile trattato con PVD una straordinaria durezza superficiale, resistenza ai raggi UV, ipoallergenicità e una maggiore resistenza all'usura e alla corrosione, rendendo così gli elettrodomestici Foster una scelta ideale per cucine sofisticate e funzionali.

Il PVD secondo **Foster**



Foster e l'acciaio

il PVD

Physical Vapor Deposition

La gamma PVD Foster Gun Metal, Gold, Copper, Gun Metal Vintage, Copper Vintage, Gold Vintage si arricchisce delle nuove colorazioni Sunset e Brandy conferendo alla vostra cucina una personalità unica e distintiva.

I colori Gun Metal e Brandy sono disponibili anche nella finitura Fumè, ad effetto mat, che rendendo la superficie dell'acciaio setosa al tatto dona maggior profondità alle colorazioni Foster PVD.

Gun Metal

Gun Metal Vintage

Gun Metal Fumè

Copper

Copper Vintage

Gold

Gold Vintage















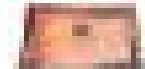













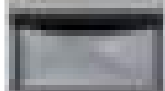

Brandy

Brandy Fumè

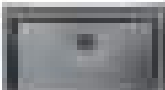
Sunset

- Aumento della durezza superficiale, maggiore resistenza ai graffi e all'usura.
- Maggiore resistenza alla corrosione.
- Inalterabilità ai raggi UV.
- Elevata resistenza alla temperatura.
- Ipoallergenico e compatibile al 100% con l'utilizzo in campo alimentare.

Lavelli e vasche

	Gun Metal	Gun Metal fumé	Copper	Gold	Brandy	Brandy fumé	Sunset
Phantom Base	BASE 80 5557 246 PB 20 5557 346 PB 12 		5557 248 PB 20 5557 348 PB 12 	5557 249 PB 20 5557 349 PB 12 			
	BASE 60 5555 246 PB 20 5555 346 PB 12 		5555 248 PB 20 5555 348 PB 12 	5555 249 PB 20 5555 349 PB 12 			
	BASE 60 5554 246 PB 20 5554 346 PB 12 		5554 248 PB 20 5554 348 PB 12 	5554 249 PB 20 5554 349 PB 12 			
Phantom	BASE 80 4371 006 FT SPT 4371 056 ST 		4371 008 FT SPT 4371 058 ST 	4371 009 FT SPT 4371 059 ST 			
	BASE 60 4350 006 FT SPT 4350 056 ST 		4350 008 FT SPT 4350 058 ST 	4350 009 FT SPT 4350 059 ST 			
	BASE 45 4340 006 FT SPT 4340 056 ST 		4340 008 FT SPT 4340 058 ST 	4340 009 FT SPT 4340 059 ST 			
Milanello	BASE 80 1034 056 FT SPT 		1034 058 FT SPT 	1034 059 FT SPT 			
	BASE 90 1034 856 ST 		1034 858 ST 	1034 859 ST 			
Quadra EVO	BASE 80/90 1257 056 FT SPT 1257 856 ST 						
	BASE 60/80 1255 056 FT SPT 1255 856 ST 						
	BASE 60 1254 056 FT SPT 1254 856 ST 						
Circolari	BASE 45 1130 066 FT SPT 1130 866 ST 		1130 068 FT SPT 1130 868 ST 	1130 069 FT SPT 1130 869 ST 			

Lavelli e vasche

Gun Metal

Gun Metal fumé

Copper

Gold

Brandy

Brandy fumé

Sunset

Quadra
R12

BASE 80

1717 056 FT SPT
1717 856 ST



1717 016 FT SPT
1717 816 ST



1717 055 FT SPT
1717 855 ST



1717 015 FT SPT
1717 815 ST



BASE 60

1715 056 FT SPT
1715 856 ST



1715 016 FT SPT
1715 816 ST



1715 055 FT SPT
1715 855 ST



1715 015 FT SPT
1715 815 ST



KE R15

BASE 80

2157 056 FT SPT
2157 856 ST



2157 058 FT SPT
2157 858 ST



2157 059 FT SPT
2157 859 ST



2157 055 FT SPT
2157 855 ST



Vintage

BASE 80

2157 086 FT SPT
2157 886 ST



2157 888 ST



2157 889 ST



BASE 60

2155 056 FT SPT
2155 856 ST



2155 058 FT SPT
2155 858 ST



2155 059 FT SPT
2155 859 ST



2155 055 FT SPT
2155 855 ST



Vintage

BASE 60

2155 086 FT SPT
2155 886 ST



2155 888 ST



2155 889 ST



BASE 60

2154 056 FT SPT
2154 856 ST



BASE 45/60

2156 056 FT SPT
2156 856 ST



2156 858 ST



2156 859 ST



Vintage

BASE 45/60

2156 086 FT SPT
2156 886 ST



2156 888 ST



2156 889 ST



BASE 45

2153 856 ST



BASE 30

2151 856 ST



















Monovasca
S1000

BASE 80

1180 156 STD





Miscelatori

	Gun Metal	Gun Metal fumé	Copper	Gold	Brandy	Brandy fumé	Sunset
Skin	 8424 856		 8424 858	 8424 859			 8424 851
Iota	 8426 106						
Omega Plus	 8498 856		 8498 858	 8498 859			 8498 851
Omega	 8497 856		 8497 400	 8497 700			
Margot	 8524 006		 8524 008	 8524 009		Dispenser EVO Gun Metal 8520 856	

Piani cottura a gas

	Gun Metal	Gun Metal fumé	Copper	Gold	Brandy	Brandy fumé	Sunset
Milanello	7682 006 FT SPT 		7682 008 FT SPT 	7682 009 FT SPT 			
	7681 006 FT SPT 		7681 008 FT SPT 	7681 009 FT SPT 			
	7680 006 FT SPT 		7680 008 FT SPT 	7680 009 FT SPT 			
Milano	7639 006 FT SPT 		7639 008 FT SPT 	7639 009 FT SPT 			
	7638 006 FT SPT 		7638 008 FT SPT 	7638 009 FT SPT 			
	7640 006 FT SPT 		7640 008 FT SPT 	7640 009 FT SPT 			

Piani cottura a gas

	Gun Metal	Gun Metal fumé	Copper	Gold	Brandy	Brandy fumé	Sunset
KE	7601 632 FT SPT 		7601 886 FT SPT 	7601 932 FT SPT 			

Forni

	Gun Metal	Gun Metal fumé	Copper	Gold	Brandy	Brandy fumé	Sunset
FL 90	7107 646 						

Accessori

	Gun Metal	Gun Metal fumé	Copper	Gold	Brandy	Brandy fumé	Sunset
Scolapasta	8151 006 		8151 008 	8151 009 			
Portaprese	8000 116 		8000 118 	8000 119 			
Pilette	8407 110 						
	8407 120 		8407 122 	8407 121 			8403 325 

Il PVD secondo **Foster**





Il PVD, Physical Vapor Deposition non è una semplice finitura, è un vero e proprio trattamento che penetra all'interno dell'acciaio inox rendendo così la colorazione inalterabile dall'usura e dal tempo.

Grazie al trattamento PVD l'acciaio dei prodotti Foster è perfetto per una cucina tutta da vivere.

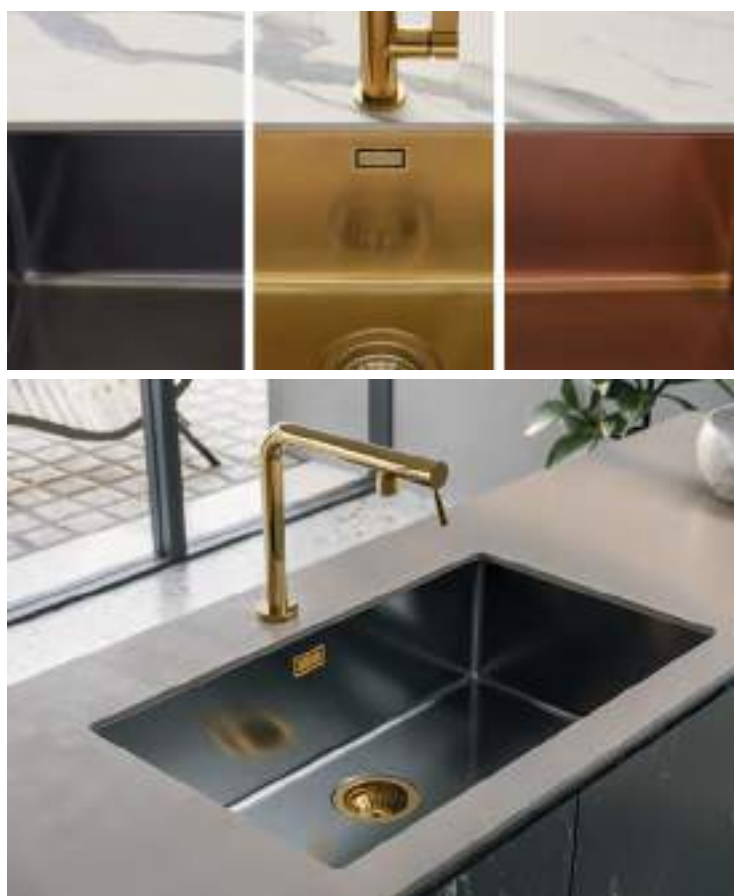

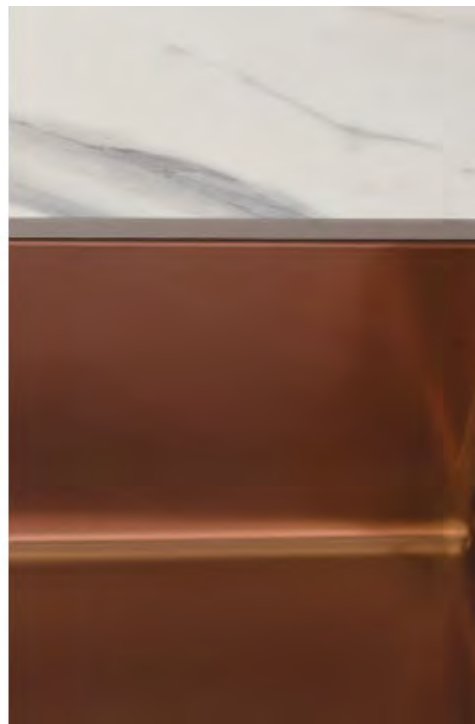
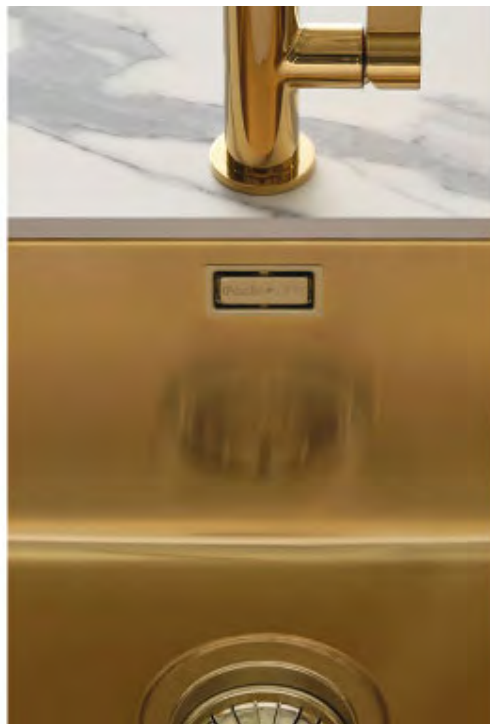
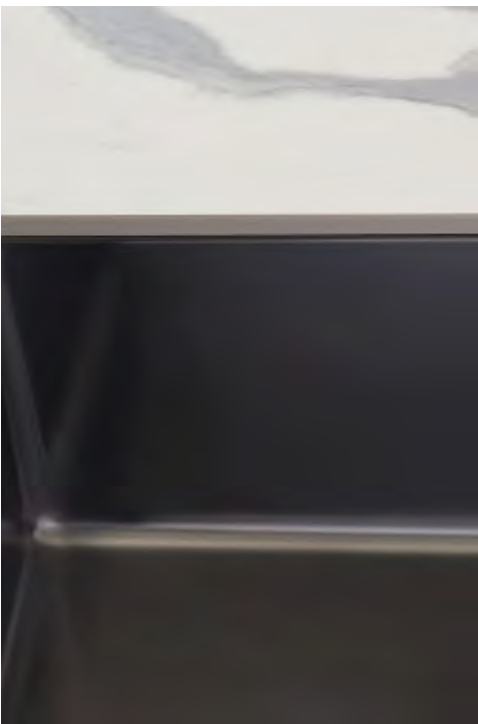
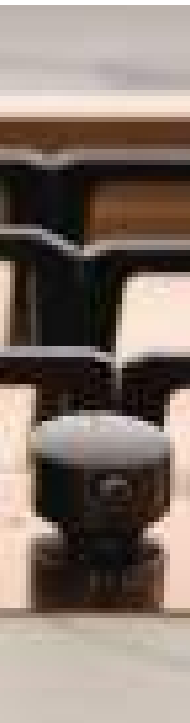



20	Gun Metal <small>NEW</small>
44	Copper <small>NEW</small>
62	Gold <small>NEW</small>
80	Brandy <small>NEW</small>
86	Sunset <small>NEW</small>

Foster PVD





PVD | Gun Metal





Base 80

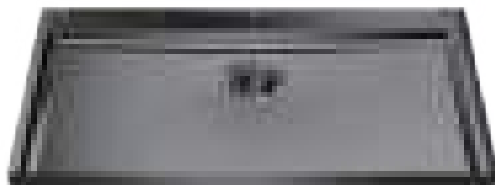

5557 246



Per lastre spessore 20 mm
Dimensioni: **756 x 446**
1 vasca: **716 x 406**

5557 346



Per lastre spessore 12 mm
Dimensioni: **740 x 430**
1 vasca: **716 x 406**

- Incasso: vedi sito web
- Fondo in acciaio AISI 304 Gun Metal
- Piletta 3½" + tubo corrugato universale per l'installazione di differente troppo pieno

Accessori e disegno tecnico a pag. 214
Pilette automatiche a pag. 33

Base 60



5555 246



Per lastre spessore 20 mm
Dimensioni: **546 x 446**
1 vasca: **506 x 406**

5555 346



Per lastre spessore 12 mm
Dimensioni: **530 x 430**
1 vasca: **506 x 406**

- Incasso: vedi sito web
- Fondo in acciaio AISI 304 Gun Metal
- Piletta 3½" + tubo corrugato universale per l'installazione di differente troppo pieno

Accessori e disegno tecnico a pag. 214
Pilette automatiche a pag. 33

Base 60



5554 246



Per lastre spessore 20 mm
Dimensioni: **446 x 446**
1 vasca: **406 x 406**

5554 346



Per lastre spessore 12 mm
Dimensioni: **430 x 430**
1 vasca: **406 x 406**

- Incasso: vedi sito web
- Fondo in acciaio AISI 304 Gun Metal
- Piletta 3½" + tubo corrugato universale per l'installazione di differente troppo pieno

Accessori e disegno tecnico a pag. 214
Pilette automatiche a pag. 33

Base 80



4371 006

FT

incasso FT: vedi sito web*

SPT

incasso SPT: 718 x 408 R16*

- Acciaio AISI 304 Gun Metal
- Dimensioni: **726 x 416** - 1 vasca: **710 x 400**
- Piletta 3½"
- *Il foro incasso necessita di intaglio per l'alloggio del troppo pieno (vedi sito web)

Accessori, disegno tecnico a pag. 100
Pilette automatiche a pag. 33

Base 80



4371 056

ST

incasso: vedi sito web

- Acciaio AISI 304 Gun Metal
- Dimensioni: **726 x 416** - 1 vasca: **710 x 400**
- Piletta 3½"

Accessori, disegno tecnico a pag. 220
Pilette automatiche a pag. 33

Base 60



4350 006

FT

incasso FT: vedi sito web*

SPT

incasso SPT: 508 x 408 R16*

- Acciaio AISI 304 Gun Metal
- Dimensioni: **516 x 416** - 1 vasca: **500 x 400**
- Piletta 3½"
- *Il foro incasso necessita di intaglio per l'alloggio del troppo pieno (vedi sito web)

Accessori, disegno tecnico a pag. 100
Pilette automatiche a pag. 33

Base 60**4350 056** **ST**

incasso: vedi sito web



- Acciaio AISI 304 Gun Metal
- Dimensioni: **516 x 416** - 1 vasca: **500 x 400**
- Piletta 3½"

Accessori, disegno tecnico a pag. 220
Pilette automatiche a pag. 33

Base 45**4340 006** **FT**

incasso FT: vedi sito web*

 **SPT**

incasso SPT: 408 x 408 R16*



- Acciaio AISI 304 Gun Metal
- Dimensioni: **416 x 416** - 1 vasca: **400 x 400**
- Piletta 3½"
- *Il foro incasso necessita di intaglio per l'alloggio del troppo pieno (vedi sito web)

Accessori, disegno tecnico a pag. 100
Pilette automatiche a pag. 33

Base 45**4340 056** **ST**

incasso: vedi sito web



- Acciaio AISI 304 Gun Metal
- Dimensioni: **416 x 416** - 1 vasca: **400 x 400**
- Piletta 3½"

Accessori, disegno tecnico a pag. 220
Pilette automatiche a pag. 33

Base 80



1034 056

FT

incasso FT: vedi sito web

SPT

incasso SPT: 789 x 503

- Acciaio AISI 304 Gun Metal
- Dimensioni: **806 x 520** - 1 vasca: **750 x 374**
- Piletta automatica Space Push (PO) 3 1/2"
- Possibilità fori aggiuntivi
- Sistema a 3 invasi

In dotazione: **2 griglie Black Milanello** (8100 602)
Accessori opzionali e disegno tecnico a pag. 106

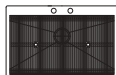

Configurazione
griglie Black
a filo vasca

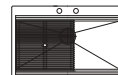

Configurazione
griglie Black
su fondo vasca

Base 90



1034 856

ST

incasso: 750 x 426

- Acciaio AISI 304 Gun Metal
- Dimensioni: **790 x 466** - 1 vasca: **750 x 426**
- Piletta SPACE 3 1/2"
- Sistema a 3 invasi

In dotazione: **2 griglie Black Milanello** (8100 602)
Accessori, disegno tecnico a pag. 226
Pilette automatiche a pag. 33



Configurazione
griglie Black
a filo vasca

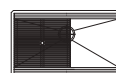

Configurazione
griglie Black
su fondo vasca

Base 80



1257 056

FT

incasso FT: vedi sito web*

SPT

incasso SPT: 760 x 450*

- Acciaio AISI 304 Gun Metal
- Dimensioni: **780 x 470** - 1 vasca: **740 x 430**
- Piletta 3½"
- * Il foro necessita di intaglio per l'alloggio del troppo pieno (vedi sito web)

In dotazione: **2 griglie** (8100 614 - 8100 615)
 Accessori, disegno tecnico a pag. 118
 Pilette automatiche a pag. 33



Configurazione griglie Black a filo vasca

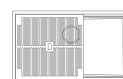

Configurazione griglie Black su fondo vasca

Base 90



1257 856

ST

incasso: 740 x 452 R5

- Acciaio AISI 304 Gun Metal
- Dimensioni: **780 x 470** - 1 vasca: **740 x 430**
- Piletta 3,5"

In dotazione: **2 griglie** (8100 614 - 8100 615)
 Accessori, disegno tecnico a pag. 238
 Pilette automatiche a pag. 33



Configurazione griglie Black a filo vasca

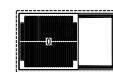

Configurazione griglie Black su fondo vasca

Base 60



1255 056

FT

incasso FT: vedi sito web*

SPT

incasso SPT: 550 x 450*

- Acciaio AISI 304 Gun Metal
- Dimensioni: **570 x 470** - 1 vasca: **530 x 430**
- Piletta 3½"
- * Il foro necessita di intaglio per l'alloggio del troppo pieno (vedi sito web)

In dotazione: **1 griglia** (8100 615)
 Accessori, disegno tecnico a pag. 118
 Pilette automatiche a pag. 33



Configurazione griglie Black a filo vasca



Configurazione griglie Black su fondo vasca

Codice

Versione

Caratteristiche

Prezzo

Base 80**1255 856**

ST

incasso: 530 x 452 R5



- Acciaio AISI 304 Gun Metal
- Dimensioni: **570 x 470** - 1 vasca: **530 x 430**
- Piletta 3,5"

In dotazione: **1 griglia** (8100 615)
 Accessori, disegno tecnico a pag. 238
 Pilette automatiche a pag. 33



Configurazione
griglie Black
a filo vasca



Configurazione
griglie Black
su fondo vasca

Base 60**1254 056**

FT

incasso FT: vedi sito web*

SPT

incasso SPT: 450 x 450*



- Acciaio AISI 304 Gun Metal
- Dimensioni: **470 x 470** - 1 vasca: **430 x 430**
- Piletta 3½"
- * Il foro necessita di intaglio per l'alloggio del troppo pieno (vedi sito web)

In dotazione: **1 griglia** (8100 615)
 Accessori, disegno tecnico a pag. 118
 Pilette automatiche a pag. 33



Configurazione
griglie Black
a filo vasca

Base 60**1254 856**

ST

incasso: 430 x 452 R5



- Acciaio AISI 304 Gun Metal
- Dimensioni: **470 x 470** - 1 vasca: **430 x 430**
- Piletta 3,5"

In dotazione: **1 griglia** (8100 615)
 Accessori, disegno tecnico a pag. 238
 Pilette automatiche a pag. 33



Configurazione
griglie Black
a filo vasca

Gun Metal Quadra R12 NEW

Codice

Versione

Caratteristiche

Prezzo

Base 80



1717 056

FT

incasso FT: vedi sito web*

SPT

incasso SPT: 730 x 430*

- Acciaio AISI 304 Gun Metal
- Dimensioni: **750 x 440** - 1 vasca: **710 x 400**
- Piletta 3½"
- *Il foro necessita di intaglio per l'alloggio del troppo-pieno (solo per top >30)

- Disponibile anche in versione **Gun Metal Fumè 1717 016**



In dotazione: **1 griglia** (8100 617)
 Accessori, disegno tecnico a pag. 124
 Pilette automatiche a pag. 33

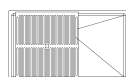

Configurazione griglie Black a filo vasca



Configurazione griglie Black su fondo vasca

Base 80



1717 856

ST

incasso: 710 x 400 R12

- Acciaio AISI 304 Gun Metal
- Dimensioni: **750 x 440** - 1 vasca: **710 x 400**
- Piletta 3,5"

- Disponibile anche in versione **Gun Metal Fumè 1717 816**



In dotazione: **1 griglia** (8100 617)
 Accessori, disegno tecnico a pag. 244
 Pilette automatiche a pag. 33

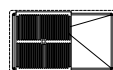

Configurazione griglie Black a filo vasca



Configurazione griglie Black su fondo vasca

Base 60



1715 056

FT

incasso FT: vedi sito web*

SPT

incasso SPT: 520 x 430*

- Acciaio AISI 304 Gun Metal
- Dimensioni: **540 x 440** - 1 vasca: **500 x 400**
- Piletta 3½"
- *Il foro necessita di intaglio per l'alloggio del troppo-pieno (solo per top >30)

- Disponibile anche in versione **Gun Metal Fumè 1715 016**



In dotazione: **1 griglia** (8100 617)
 Accessori, disegno tecnico a pag. 124
 Pilette automatiche a pag. 33



Configurazione griglie Black a filo vasca



Configurazione griglie Black su fondo vasca

Base 60



Codice	Versione	Caratteristiche	Prezzo
--------	----------	-----------------	--------

1715 856	ST	incasso: 500 x 400 R12	
-----------------	----	------------------------	--

- Acciaio AISI 304 Gun Metal
- Dimensioni: **540 x 440** - 1 vasca: **500 x 400**
- Piletta 3,5"

- Disponibile anche in versione **Gun Metal Fumè**
1715 816



In dotazione: **1 griglia** (8100 617)
Accessori, disegno tecnico a pag. 244
Pilette automatiche a pag. 33



Configurazione
griglie Black
a filo vasca



Configurazione
griglie Black
su fondo vasca

Gun Metal Circolari NEW

Base 45



Accessori, disegno tecnico a pag. 132

Codice	Versione	Caratteristiche	Prezzo
--------	----------	-----------------	--------

1130 066	FT	incasso FT: vedi sito web*	
	SPT	incasso SPT: Ø 410*	

- Acciaio AISI 304 Gun Metal
- Dimensioni: **Ø 425** - 1 vasca: **Ø 380**
- Piletta 3½"
- *Il foro di incasso necessita di intaglio per l'alloggio del troppo pieno

Base 60



Accessori, disegno tecnico a pag. 252

1130 866	ST	incasso: Ø 380	
-----------------	----	----------------	--

- Acciaio AISI 304 Gun Metal
- Dimensioni: **Ø 425** - 1 vasca: **Ø 380**
- Piletta 3½"

Base 80



Accessori, disegno tecnico a pag. 162
Pilette automatiche a pag. 33

2157 056

FT

incasso FT: vedi sito web*

SPT

incasso SPT: 730 x 420*

- Acciaio AISI 304 Gun Metal
- Dimensioni: **750 x 440** - 1 vasca: **710 x 400**
- Piletta 3½"

* Il foro incasso necessita di intaglio per l'alloggio del troppo-pieno (vedi sito web)

- Disponibile anche in versione **Vintage 2157 086**



Base 80



Accessori, disegno tecnico a pag. 270
Pilette automatiche a pag. 33

2157 856

ST

incasso: 710 x 400 R15

- Acciaio AISI 304 Gun Metal
- Dimensioni: **750 x 440** - 1 vasca: **710 x 400**
- Piletta 3½"

- Disponibile anche in versione **Vintage 2157 886**



Base 60



Accessori, disegno tecnico a pag. 162
Pilette automatiche a pag. 33

2155 056

FT

incasso FT: vedi sito web*

SPT

incasso SPT: 520 x 420*

- Acciaio AISI 304 Gun Metal
- Dimensioni: **540 x 440** - 1 vasca: **500 x 400**
- Piletta 3½"

* Il foro incasso necessita di intaglio per l'alloggio del troppo-pieno (vedi sito web)

- Disponibile anche in versione **Vintage 2155 086**



Codice

Versione

Caratteristiche

Prezzo

Base 60

2155 856

ST

incasso: 500 x 400 R15

- Acciaio AISI 304 Gun Metal
- Dimensioni: **540 x 440** - 1 vasca: **500 x 400**
- Piletta 3½"

- Disponibile anche in versione **Vintage**
2155 886



Accessori, disegno tecnico a pag. 270
Pilette automatiche a pag. 33

Base 60

2154 056

FT

incasso FT: vedi sito web*

SPT

incasso SPT: 470 x 420*

- Acciaio AISI 304 Gun Metal
- Dimensioni: **490 x 440** - 1 vasca: **450 x 400**
- Piletta 3½"

* Il foro incasso necessita di intaglio per l'alloggio del troppo-pieno
(vedi sito web)



Accessori, disegno tecnico a pag. 162
Pilette automatiche a pag. 33

Base 60

2154 856

ST

incasso: 450 x 400 R15

- Acciaio AISI 304 Gun Metal
- Dimensioni: **490 x 440** - 1 vasca: **450 x 400**
- Piletta 3½"



Accessori, disegno tecnico a pag. 270
Pilette automatiche a pag. 33

Base 45



2156 056

 FT

incasso FT: vedi sito web*

 SPT

incasso SPT: 420 x 420*

- Acciaio AISI 304 Gun Metal
- Dimensioni: **440 x 440** - 1 vasca: **400 x 400**
- Piletta 3½"

* Il foro incasso necessita di intaglio per l'alloggio del troppo-pieno (vedi sito web)

- Disponibile anche in versione **Vintage**
2156 086



Accessori, disegno tecnico a pag. 162
Pilette automatiche a pag. 33

Base 60



2156 856

 ST

incasso: 400 x 400 R15

- Acciaio AISI 304 Gun Metal
- Dimensioni: **440 x 440** - 1 vasca: **400 x 400**
- Piletta 3½"

- Disponibile anche in versione **Vintage**
2156 886



Accessori, disegno tecnico a pag. 270
Pilette automatiche a pag. 33

Base 45



2153 856

 ST

incasso: 340 x 400 R15

- Acciaio AISI 304 Gun Metal
- Dimensioni: **380 x 440** - 1 vasca: **340 x 400**
- Piletta 3½"

Accessori, disegno tecnico a pag. 270
Pilette automatiche a pag. 33

Codice

Versione

Caratteristiche

Prezzo

Base 30

2151 856

ST

incasso: 180 x 400 R15



- Acciaio AISI 304 Gun Metal
- Dimensioni: **222 x 442** - 1 vasca: **180 x 400**
- Piletta 3½"

Accessori, disegno tecnico a pag. 270
Pilette automatiche a pag. 33

Gun Metal Monovasca S1000 NEW

Base 80

1180 156

BR

incasso: 840 x 480



- Acciaio AISI 304 Gun Metal
- Dimensioni: **865 x 505** - 1 vasca: **726 x 350**
- Piletta 3½"
- Possibilità fori aggiuntivi

Accessori, disegno tecnico a pag. 202
Pilette automatiche a pag. 33

Gun Metal Accessori e pilette automatiche

Z5

Vaschetta forata inox
21,5x38 cm
8151 006

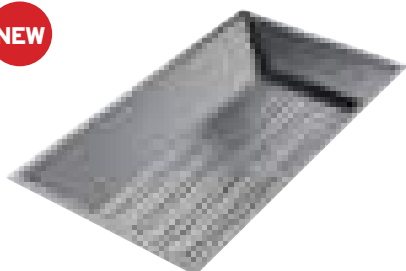
NEW

Da utilizzare abbinato a

N3 8644 101

K2 8100 037

K1 8100 627

PG

8407 110

Piletta automatica **Gun metal** con comando remoto tondo rotante e con troppo/pieno perimetrale



PO

8407 120

Piletta automatica **Space Push Gun Metal** con comando remoto rotondo a pressione e con troppo/pieno perimetrale. Doppio tappo in dotazione: Space e "a cestello".





Caratteristiche

- Miscelatore monocomando
- Canna girevole snodabile
- Base d'appoggio: Ø 50 mm

Codice

8424 856

Prezzo

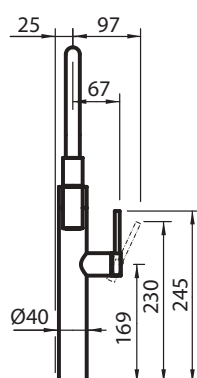
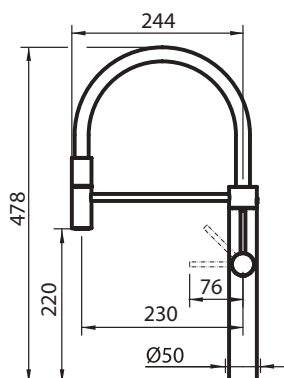

Caratteristiche



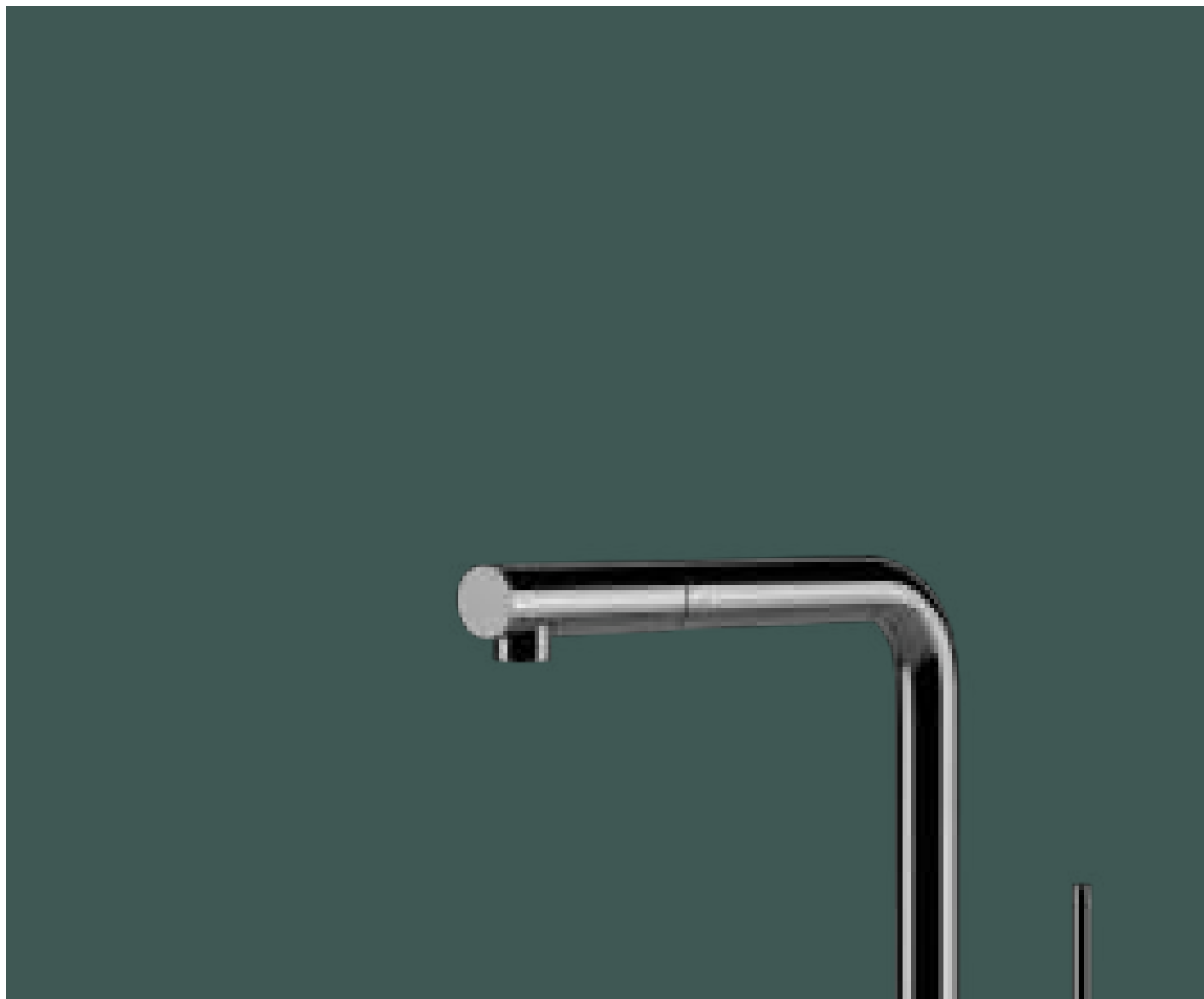

Caratteristiche

- Miscelatore monocomando
- Canna girevole e bocca snodabile
- Base d'appoggio: \varnothing 50 mm

Codice

8426106
Satinato

Prezzo

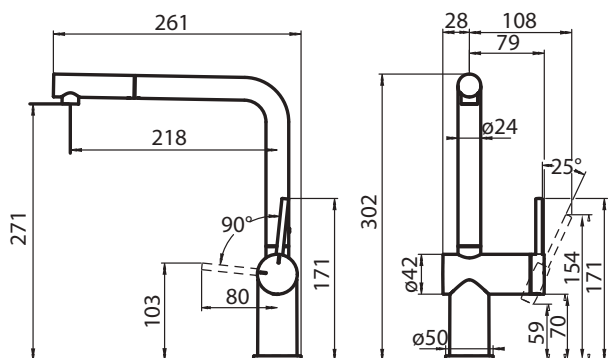

Funzioni



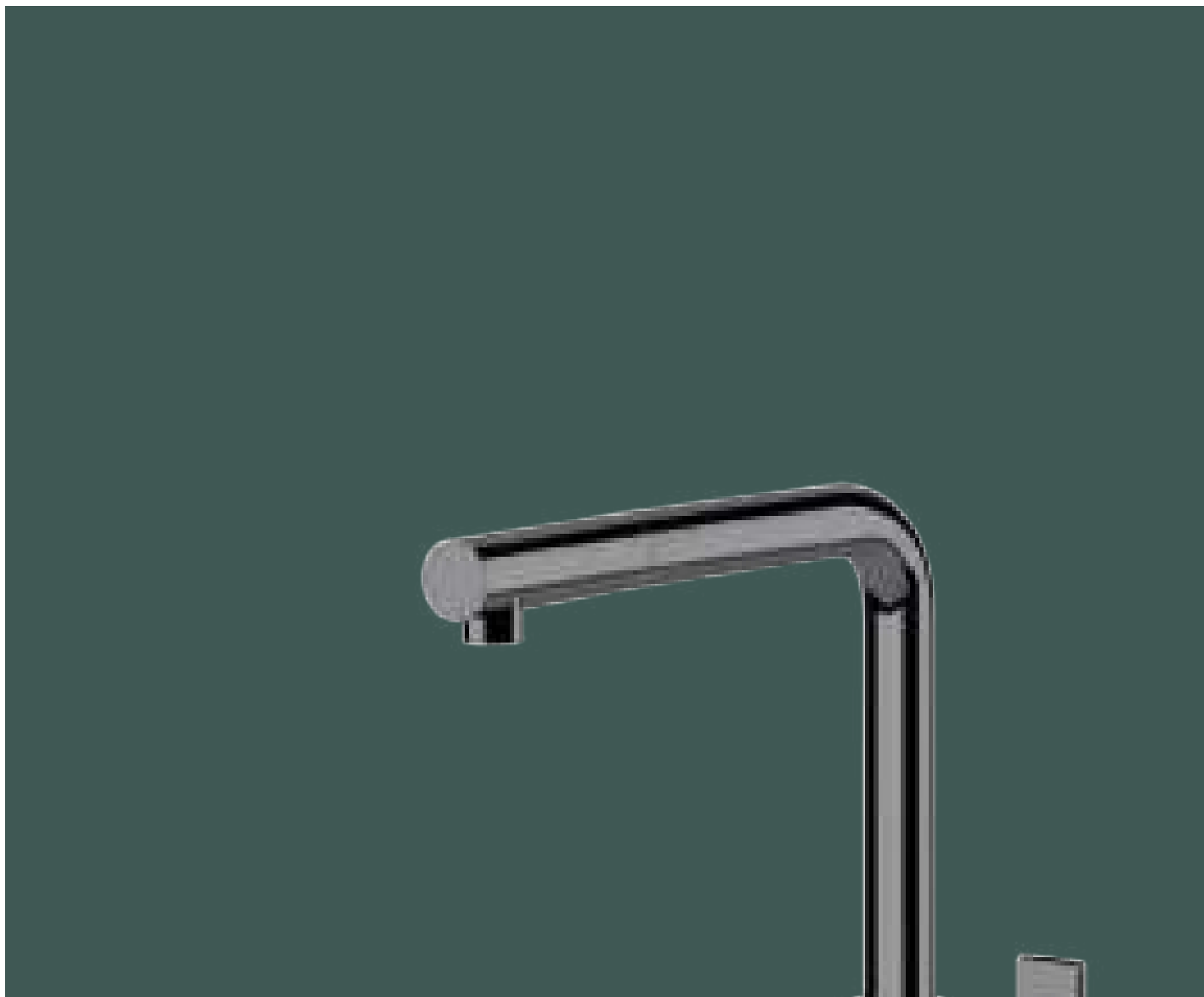

Caratteristiche

- Miscelatore monocomando
- Canna girevole e bocca estraibile
- Base d'appoggio: \varnothing 50 mm

Codice

8498 856

Prezzo

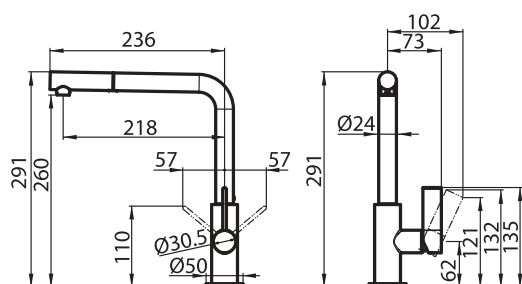
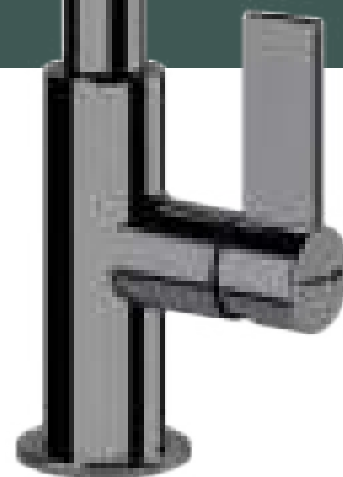

Funzioni





Caratteristiche

- Miscelatore monocomando
- Canna girevole
- Base d'appoggio: \varnothing 50 mm

Codice

8497 856

Prezzo

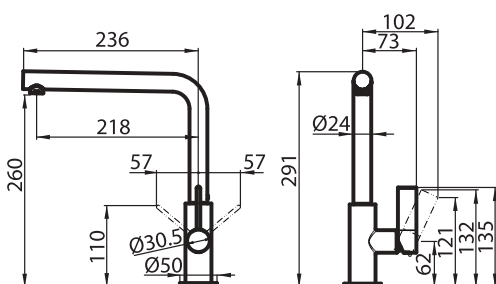
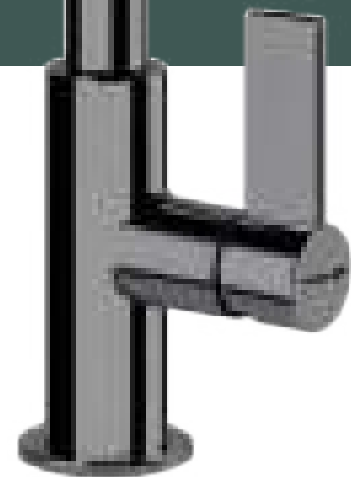

Funzioni





Caratteristiche

- Miscelatore monocomando
- Canna girevole a scomparsa up&down
- Base d'appoggio: \varnothing 55 mm

Codice

8524 006

Prezzo

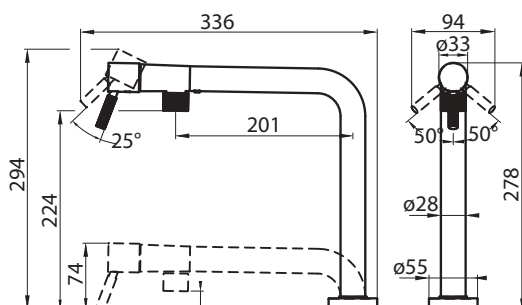

Funzioni



Gun Metal Dispenser Evo

Caratteristiche

Codice

Prezzo

PVD



Distributore da incasso per detersivo/
sapone liquido

8520 856

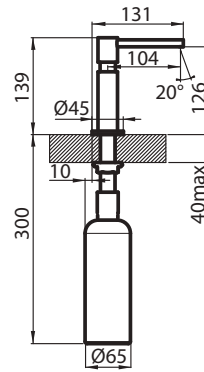



Accessori: **2** (vedi pag. 401)

Disegno tecnico a pag. 430

7682 006

FT

incasso FT: vedi sito web

SPT

incasso SPT: 790x500

- AISI 304 Gun Metal
- Dimensioni: **803 x 513**
- Griglie in ghisa e coprispartifiamma smaltati
- Accensione elettrica
- Valvolatura di sicurezza con termocoppia ad intervento rapido
- Potenza tot. 10.250 W
ausiliario: 1.000 W
semirapido: 3x1.750 W
doppia corona: 4.000 W

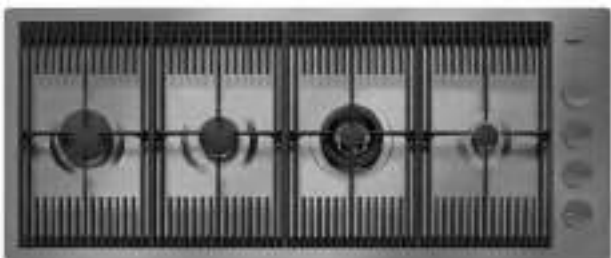

Accessori: **2** (vedi pag. 401)

Disegno tecnico a pag. 430

7681 006

FT

incasso FT: vedi sito web

SPT

incasso SPT: 1098x459

- AISI 304 Gun Metal
- Dimensioni: **1115 x 476**
- Griglie in ghisa e coprispartifiamma smaltati
- Accensione elettrica
- Valvolatura di sicurezza con termocoppia ad intervento rapido
- Potenza tot. 10.750 W
ausiliario: 1.000 W
semirapido: 1.750 W
rapido: 3.000 W
dual: 5.000 W



Accessori: **2** (vedi pag. 401)

Disegno tecnico a pag. 430

7680 006

FT

incasso FT: vedi sito web

SPT

incasso SPT: 853x459

- AISI 304 Gun Metal
- Dimensioni: **870 x 476**
- Griglie in ghisa e coprispartifiamma smaltati
- Accensione elettrica
- Valvolatura di sicurezza con termocoppia ad intervento rapido
- Potenza tot. 7.750 W
ausiliario: 1.000 W
semirapido: 1.750 W
dual: 5.000 W

Codice	Versione	Caratteristiche	Prezzo
--------	----------	-----------------	--------

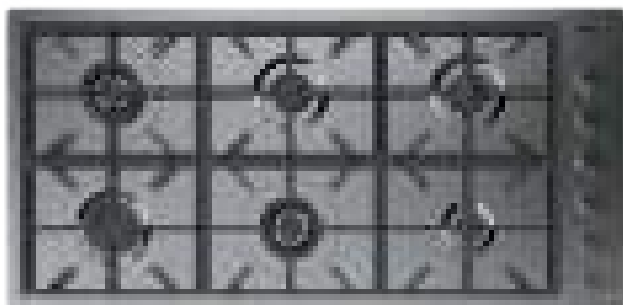

7639 006	FT	incasso FT: vedi sito web	
	SPT	incasso SPT: 1134x540	

- AISI 304 Gun Metal
 - Dimensioni: **1154x560**
 - Griglie in ghisa e coprispartifiamma smaltati
 - Accensione elettrica
 - Valvolatura di sicurezza con termocoppia ad intervento rapido
- Potenza tot. 15.900 W
 - ausiliario: 1.000 W
 - semirapido: 2x1.750 W
 - rapido: 3.000 W
 - dual: 2x4.200 W



In dotazione: 2x **2** (vedi pag. 401)

Disegno tecnico a pag. 430

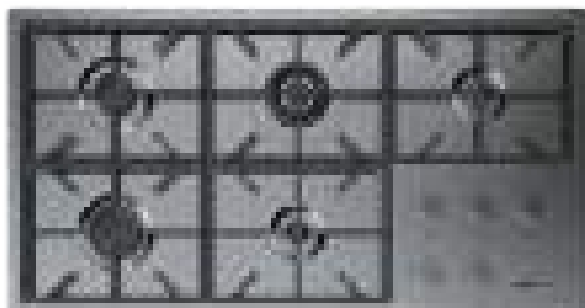

7638 006	FT	incasso FT: vedi sito web	
	SPT	incasso SPT: 1036x540	

- AISI 304 Gun Metal
 - Dimensioni: **1056x560**
 - Griglie in ghisa e coprispartifiamma smaltati
 - Accensione elettrica
 - Valvolatura di sicurezza con termocoppia ad intervento rapido
- Potenza tot. 10.950 W
 - ausiliario: 2x1.000 W
 - semirapido: 1.750 W
 - rapido: 3.000 W
 - dual: 4.200 W



In dotazione: **2** (vedi pag. 401)

Disegno tecnico a pag. 430



7640 006	FT	incasso FT: vedi sito web	
	SPT	incasso SPT: 1060x470	

- AISI 304 Gun Metal
 - Dimensioni: **1080x490**
 - Griglie in ghisa e coprispartifiamma smaltati
 - Accensione elettrica
 - Valvolatura di sicurezza con termocoppia ad intervento rapido
- Potenza tot. 9.950 W
 - ausiliario: 1.000 W
 - semirapido: 1.750 W
 - rapido: 3.000 W
 - dual: 4.200 W



In dotazione: **2** (vedi pag. 401)

Disegno tecnico a pag. 430

Gun Metal KE

Codice

Versione

Caratteristiche

Prezzo

7601 632

FT

incasso FT: vedi sito web

SPT

incasso SPT: 790x500

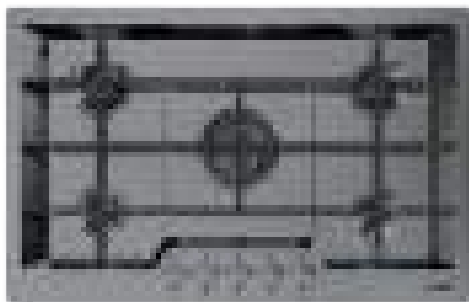

Accessori: **2** (vedi pag. 401)

Disegno tecnico a pag. 430

- AISI 304 Gun Metal
- Dimensioni: **803x513**
- Griglie in ghisa e coprispartifiamma smaltati
- Accensione elettrica
- Valvolatura di sicurezza con termocoppia ad intervento rapido

- Potenza tot. 9.500 W
- ausiliario: 2x1.100 W
- semirapido: 2x1.750 W
- tripla corona: 3.800

Gun Metal Portaprese

Codice

Prezzo



8000 116

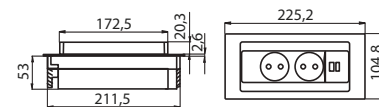

Slot portaprese push in acciaio inox PVD Gun Metal per incasso su piani da lavoro.
2 prese schuko - 1 porta usb per ricarica.
Foro incasso: **215 x 88**



**Multifunzione 90 x 48 | 91 litri
Classe A**



Codice

Finitura

Prezzo

7107 646

Gun Metal

- 10 funzioni di cottura
- Display con programmazione elettronica di inizio-fine cottura e comandi push-pull
- Maxi-Grill (abbattibile)
- Protezione resistenza Grill
- Illuminazione alogena su entrambe le pareti, attiva all'apertura della porta
- Interruttore di contatto della porta
- Alimentazione: 220-240V 50-60Hz
- Vetri removibili
- Smaltatura easy clean
- 2 guide telescopiche
- Porta full glass
- Porta con triplo vetro
- Capacità della camera di cottura XXL
- Tangenziale

Dotazione di serie:

- teglia profonda
- griglia inox

Funzioni



Disegno tecnico a pag. 454

PVD | Copper



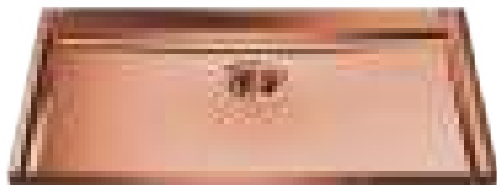

Base 80**5557 248**

PB 20

Per lastre spessore: 20 mm
 Dimensioni: **756 x 446**
 1 vasca: **716 x 406**

5557 348

PB 12

Per lastre spessore: 12 mm
 Dimensioni: **740 x 430**
 1 vasca: **716 x 406**

- Incasso: vedi sito web
- Fondo in acciaio AISI 304 Copper
- Piletta 3½" + tubo corrugato universale per l'installazione di differente troppo pieno

Accessori, disegno tecnico a pag. 214

Pilette automatiche a pag. 52

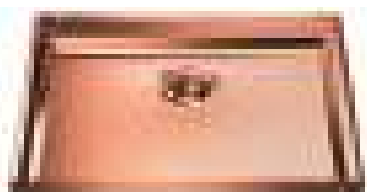
Base 60**5555 248**

PB 20

Per lastre spessore: 20 mm
 Dimensioni: **546 x 446**
 1 vasca: **506 x 406**

5555 348

PB 12

Per lastre spessore: 12 mm
 Dimensioni: **530 x 430**
 1 vasca: **506 x 406**

- Incasso: vedi sito web
- Fondo in acciaio AISI 304 Copper
- Piletta 3½" + tubo corrugato universale per l'installazione di differente troppo pieno

Accessori, disegno tecnico a pag. 214

Pilette automatiche a pag. 52

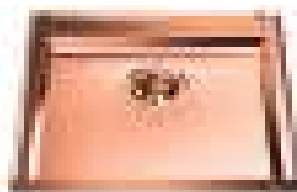
Base 60**5554 248**

PB 20

Per lastre spessore: 20 mm
 Dimensioni: **446 x 446**
 1 vasca: **406 x 406**

5554 348

PB 12

Per lastre spessore: 12 mm
 Dimensioni: **430 x 430**
 1 vasca: **406 x 406**

- Incasso: vedi sito web
- Fondo in acciaio AISI 304 Copper
- Piletta 3½" + tubo corrugato universale per l'installazione di differente troppo pieno

Accessori, disegno tecnico a pag. 214

Pilette automatiche a pag. 52

Base 80

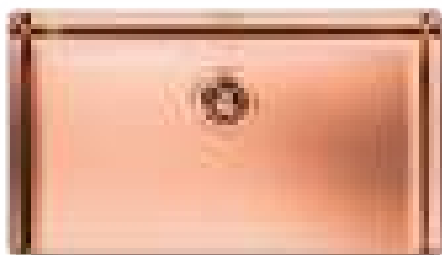

4371 008

FT

incasso FT: vedi sito web*

SPT

incasso SPT: 718 x 408 R16*

- Acciaio AISI 304 Copper
- Dimensioni: **726 x 416** - 1 vasca: **710 x 400**
- Piletta 3½"
- *Il foro incasso necessita di intaglio per l'alloggio del troppo pieno (vedi sito web)

Accessori, disegno tecnico a pag. 100
Pilette automatiche a pag. 52

Base 80



4371 058

ST

incasso: vedi sito web

- Acciaio AISI 304 Copper
- Dimensioni: **726 x 416** - 1 vasca: **710 x 400**
- Piletta 3½"

Accessori, disegno tecnico a pag. 220
Pilette automatiche a pag. 52

Base 60

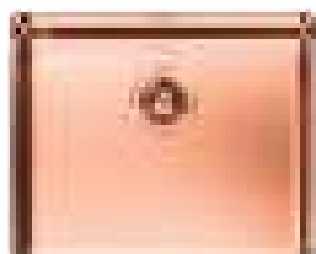

4350 008

FT

incasso FT: vedi sito web*

SPT

incasso SPT: 508 x 408 R16*

- Acciaio AISI 304 Copper
- Dimensioni: **516 x 416** - 1 vasca: **500 x 400**
- Piletta 3½"
- *Il foro incasso necessita di intaglio per l'alloggio del troppo pieno (vedi sito web)

Accessori, disegno tecnico a pag. 100
Pilette automatiche a pag. 52

| Base 60

4350 058

ST

incasso: vedi sito web

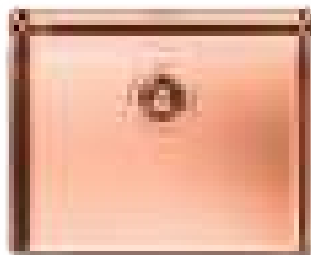

- Acciaio AISI 304 Copper
- Dimensioni: **516 x 416** - 1 vasca: **500 x 400**
- Piletta 3½"

Accessori, disegno tecnico a pag. 220
Pilette automatiche a pag. 52

| Base 45

4340 008

FT

incasso FT: vedi sito web*

SPT

incasso SPT: 408 x 408 R16*

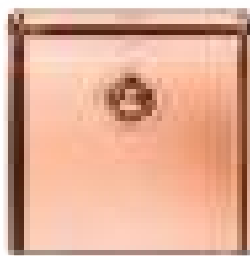

- Acciaio AISI 304 Copper
- Dimensioni: **416 x 416** - 1 vasca: **400 x 400**
- Piletta 3½"
- *Il foro incasso necessita di intaglio per l'alloggio del troppo pieno (vedi sito web)

Accessori, disegno tecnico a pag. 100
Pilette automatiche a pag. 52

| Base 45

4340 058

ST

incasso: vedi sito web

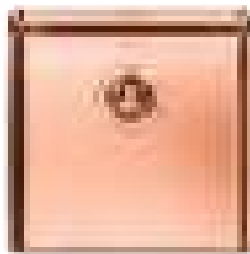

- Acciaio AISI 304 Copper
- Dimensioni: **416 x 416** - 1 vasca: **400 x 400**
- Piletta 3½"

Accessori, disegno tecnico a pag. 220
Pilette automatiche a pag. 52

Base 80



In dotazione: **2 griglie Black Milanello** (8100 602)
Accessori e disegno tecnico a pag. 106

1034 058

FT

incasso FT: vedi sito web

SPT

incasso SPT: 789 x 503

- Acciaio AISI 304 Copper
- Dimensioni: **806 x 520** - 1 vasca: **750 x 374**
- Piletta automatica Space Push (PB) 3 ½"
- Possibilità fori aggiuntivi
- Sistema a 3 invasi

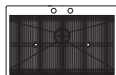

Configurazione
griglie Black
a filo vasca

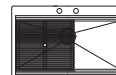

Configurazione
griglie Black
su fondo vasca

Base 90

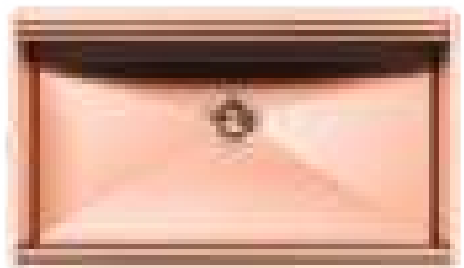

In dotazione: **2 griglie Black Milanello** (8100 602)
Accessori, disegno tecnico a pag. 226
Pilette automatiche a pag. 52

1034 858

ST

incasso: 750 x 426

- Acciaio AISI 304 Copper
- Dimensioni: **790 x 466** - 1 vasca: **750 x 374**
- Piletta SPACE 3 ½"
- Sistema a 3 invasi



Configurazione
griglie Black
a filo vasca

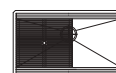

Configurazione
griglie Black
su fondo vasca

Base 80



2157 058

FT

incasso FT: vedi sito web*

SPT

incasso SPT: 730 x 420*

- Acciaio AISI 304 Copper
- Dimensioni: **750 x 440** - 1 vasca: **710 x 400**
- Piletta 3½"

* Il foro incasso necessita di intaglio per l'alloggio del troppo-pieno (vedi sito web)

Accessori, disegno tecnico a pag. 162
Pilette automatiche a pag. 52

Base 80



2157 858

ST

incasso: 710 x 400 R15

- Acciaio AISI 304 Copper
- Dimensioni: **750 x 440** - 1 vasca: **710 x 400**
- Piletta 3½"

• Disponibile anche in versione **Vintage**
2157 888



Accessori, disegno tecnico a pag. 270
Pilette automatiche a pag. 52

Base 60

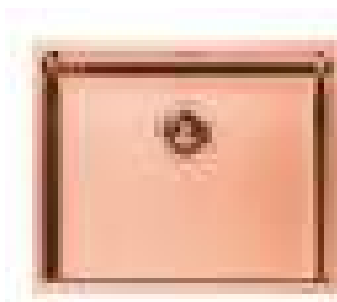

2155 058

FT

incasso FT: vedi sito web*

SPT

incasso SPT: 520 x 420*

- Acciaio AISI 304 Copper
- Dimensioni: **540 x 440** - 1 vasca: **500 x 400**
- Piletta 3½"

* Il foro incasso necessita di intaglio per l'alloggio del troppo-pieno (vedi sito web)

Accessori, disegno tecnico a pag. 162
Pilette automatiche a pag. 52

Codice

Versione

Caratteristiche

Prezzo

Base 60

2155 858

ST

incasso: 500 x 400 R15

- Acciaio AISI 304 Copper
- Dimensioni: **540 x 440** - 1 vasca: **500 x 400**
- Piletta 3½"

- Disponibile anche in versione **Vintage**
2155 888

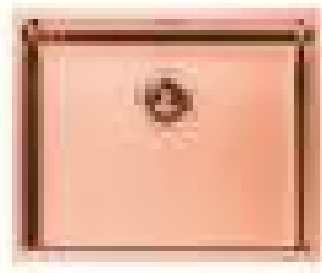

Accessori, disegno tecnico a pag. 270
Pilette automatiche a pag. 52

Base 60

2156 858

ST

incasso: 400 x 400 R15

- Acciaio AISI 304 Copper
- Dimensioni: **440 x 440** - 1 vasca: **400 x 400**
- Piletta 3½"

- Disponibile anche in versione **Vintage**
2156 888

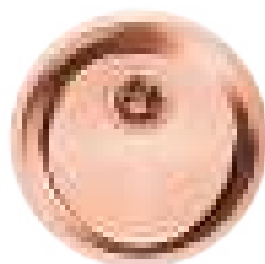

Accessori, disegno tecnico a pag. 270
Pilette automatiche a pag. 52

Base 45**1130 068**

FT

incasso FT: vedi sito web*

SPT

incasso SPT: Ø 410*

- Acciaio AISI 304 Copper
- Dimensioni: Ø 425 - 1 vasca: Ø 380
- Piletta 3½"
- *Il foro di incasso necessita di intaglio per l'alloggio del troppo pieno

Accessori, disegno tecnico a pag. 132

Base 60**1130 868**

ST

incasso: Ø 380

- Acciaio AISI 304 Copper
- Dimensioni: Ø 425 - 1 vasca: Ø 380
- Piletta 3½"

Accessori, disegno tecnico a pag. 252

Accessori e pilette automatiche

Z6

Vaschetta forata inox
21,5x38 cm
8151 008

NEW

Da utilizzare abbinato a

N3 8644 101**K2** 8100 037**K1** 8100 627**PB****8407 122****NEW**

Piletta automatica **Space Push Copper** con comando remoto rotondo a pressione e con troppo/pieno perimetrale. Doppio tappo in dotazione: Space inox e "a cestello".

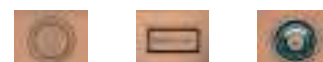





Caratteristiche

- Miscelatore monocomando
- Canna girevole e snodabile
- Base d'appoggio: Ø 50 mm

Codice

8424 858

Prezzo

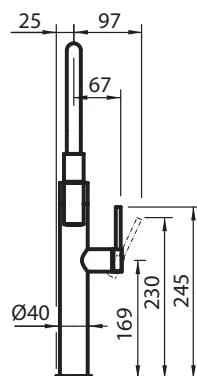
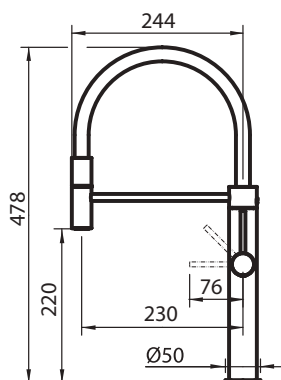

Caratteristiche



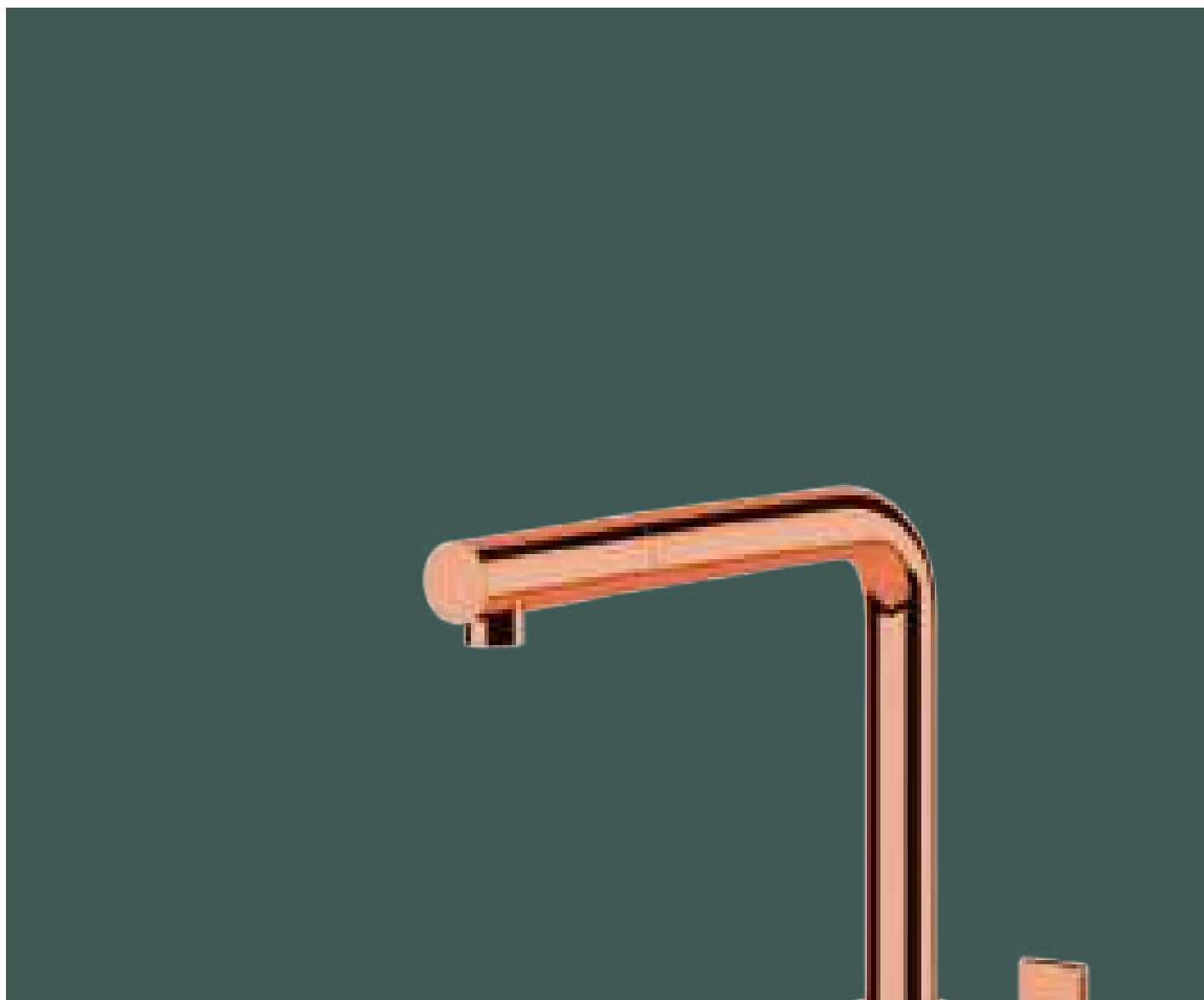

Caratteristiche

- Miscelatore monocomando
- Canna girevole e bocca estraibile
- Base d'appoggio: \varnothing 50 mm

Codice

8498 858

Prezzo

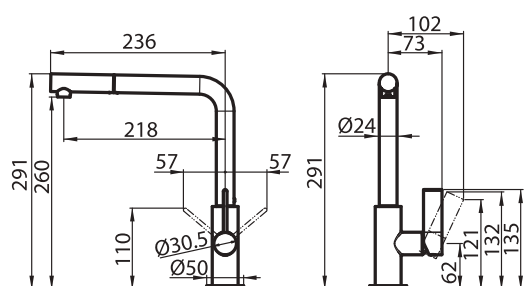
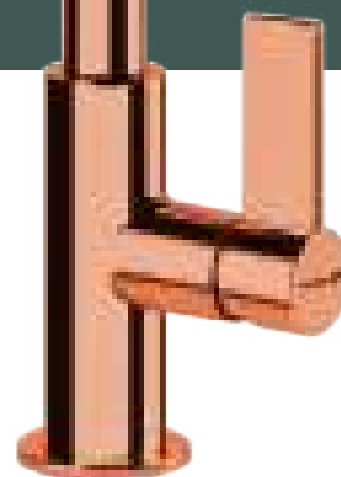

Funzioni





Caratteristiche

- Miscelatore monocomando
- Canna girevole
- Base d'appoggio: \varnothing 50 mm

Codice

8497 400

Prezzo

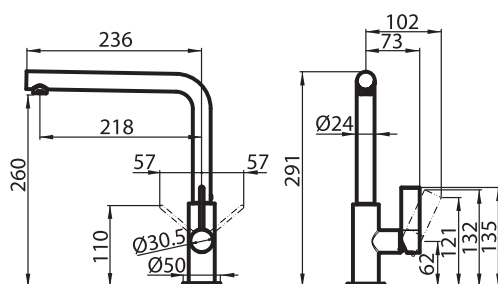
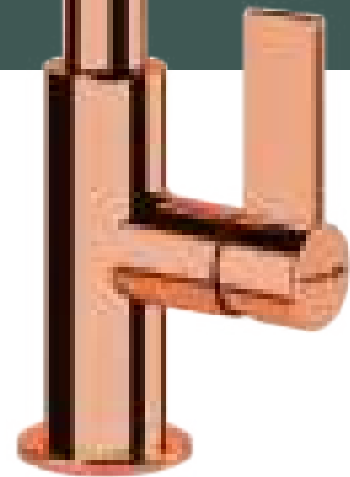

Funzioni



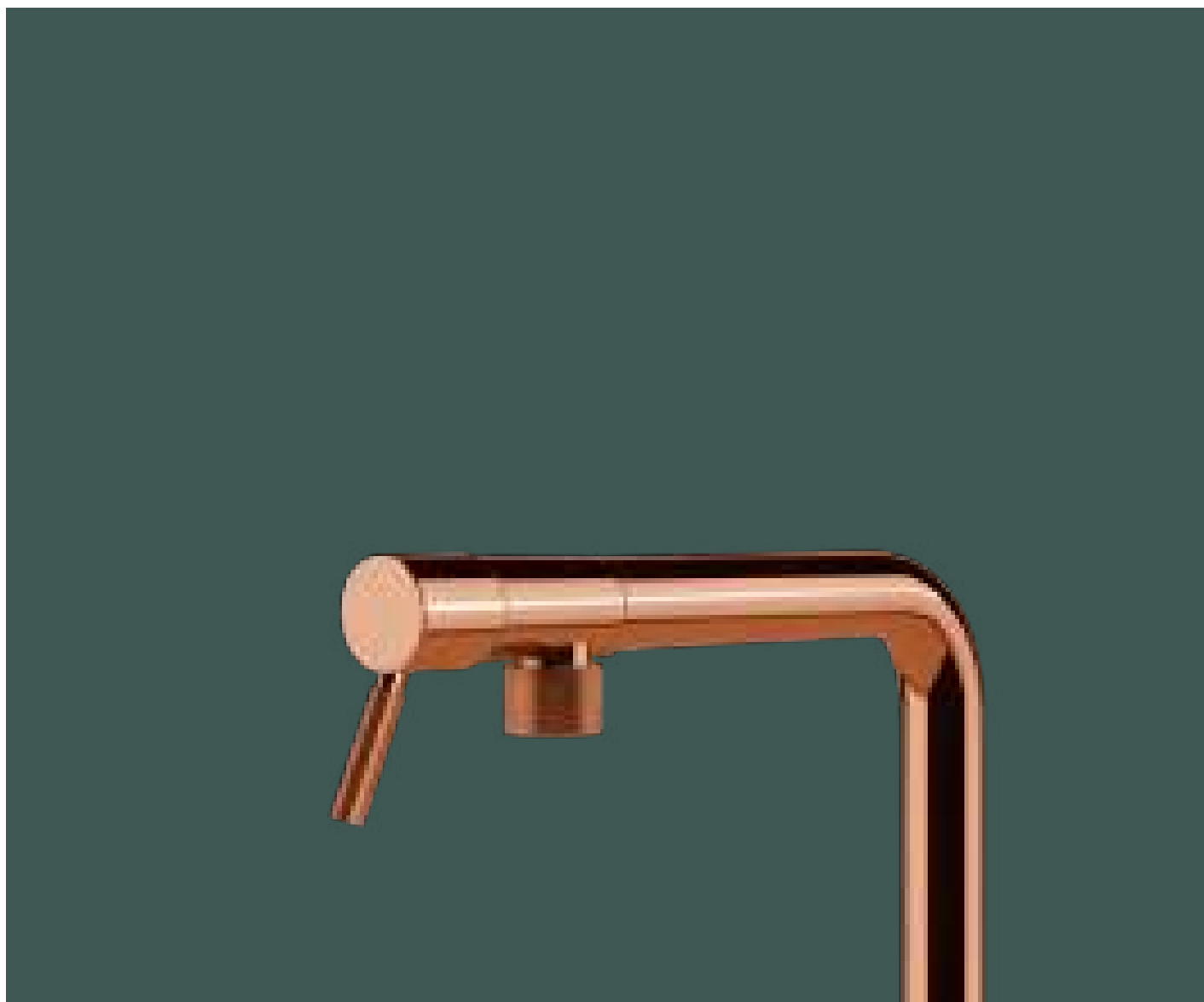

Caratteristiche

Codice

Prezzo

- Miscelatore monocomando
- Canna girevole a scomparsa up&down
- Base d'appoggio: \varnothing 55 mm

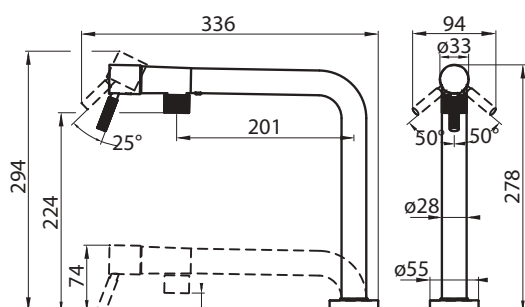
8524 008

Funzioni





Accessori: **2** (vedi pag. 401)

Disegno tecnico a pag. 430

7682 008

FT

incasso FT: vedi sito web

SPT

incasso SPT: 790x500

- AISI 304 Copper
- Dimensioni: **803 x 513**
- Griglie in ghisa e coprispartifiamma smaltati
- Accensione elettrica
- Valvolatura di sicurezza con termocoppia ad intervento rapido
- Potenza tot. 10.250 W
ausiliario: 1.000 W
semirapido: 3x1.750 W
doppia corona: 4.000 W

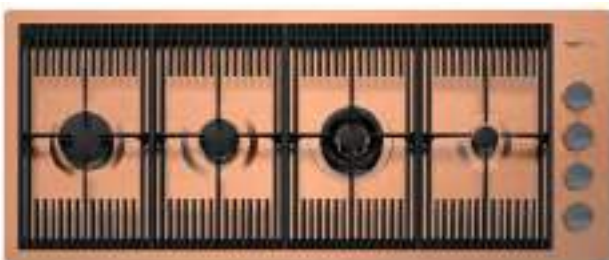

Accessori: **2** (vedi pag. 401)

Disegno tecnico a pag. 430

7681 008

FT

incasso FT: vedi sito web

SPT

incasso SPT: 1098x459

- AISI 304 Copper
- Dimensioni: **1115 x 476**
- Griglie in ghisa e coprispartifiamma smaltati
- Accensione elettrica
- Valvolatura di sicurezza con termocoppia ad intervento rapido
- Potenza tot. 10.750 W
ausiliario: 1.000 W
semirapido: 1.750 W
rapido: 3.000 W
dual: 5.000 W



Accessori: **2** (vedi pag. 401)

Disegno tecnico a pag. 430

7680 008

FT

incasso FT: vedi sito web

SPT

incasso SPT: 853x459

- AISI 304 Copper
- Dimensioni: **870 x 476**
- Griglie in ghisa e coprispartifiamma smaltati
- Accensione elettrica
- Valvolatura di sicurezza con termocoppia ad intervento rapido
- Potenza tot. 7.750 W
ausiliario: 1.000 W
semirapido: 1.750 W
dual: 5.000 W

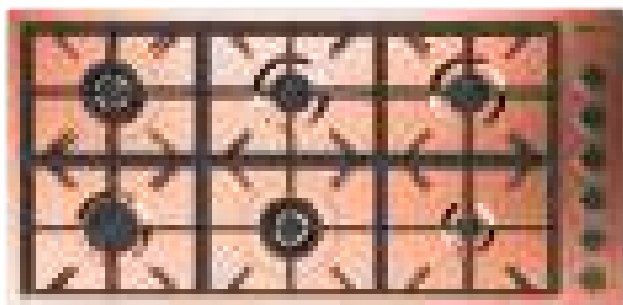

In dotazione: 2x **2** (vedi pag. 401)

Disegno tecnico a pag. 430

7639 008

FT

incasso FT: vedi sito web

SPT

incasso SPT: 1134x540

- AISI 304 Copper
- Dimensioni: **1154x560**
- Griglie in ghisa e coprispartifiamma smaltati
- Accensione elettrica
- Valvolatura di sicurezza con termocoppia ad intervento rapido
- Potenza tot. 15.900 W
ausiliario: 1.000 W
semirapido: 2x1.750 W
rapido: 3.000 W
dual: 2x4.200 W

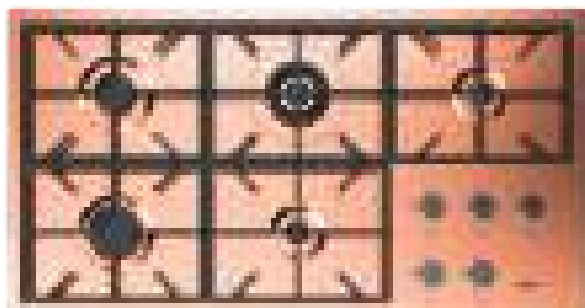

In dotazione: **2** (vedi pag. 401)

Disegno tecnico a pag. 430

7638 008

FT

incasso FT: vedi sito web

SPT

incasso SPT: 1036x540

- AISI 304 Copper
- Dimensioni: **1056x560**
- Griglie in ghisa e coprispartifiamma smaltati
- Accensione elettrica
- Valvolatura di sicurezza con termocoppia ad intervento rapido
- Potenza tot. 10.950 W
ausiliario: 2x1.000 W
semirapido: 1.750 W
rapido: 3.000 W
dual: 4.200 W

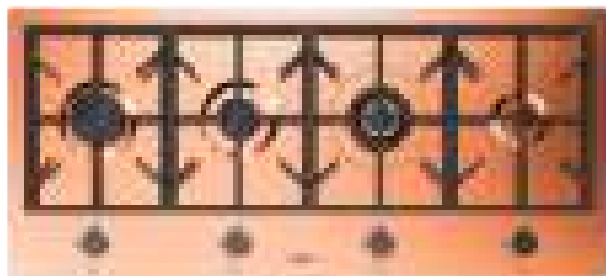

In dotazione: **2** (vedi pag. 401)

Disegno tecnico a pag. 430

7640 008

FT

incasso FT: vedi sito web

SPT

incasso SPT: 1060x470

- AISI 304 Copper
- Dimensioni: **1080x490**
- Griglie in ghisa e coprispartifiamma smaltati
- Accensione elettrica
- Valvolatura di sicurezza con termocoppia ad intervento rapido
- Potenza tot. 9.950 W
ausiliario: 1.000 W
semirapido: 1.750 W
rapido: 3.000 W
dual: 4.200 W



Copper

KE

Codice

Versione

Caratteristiche

Prezzo

7601 866

FT

incasso FT: vedi sito web

SPT

incasso SPT: 790x500

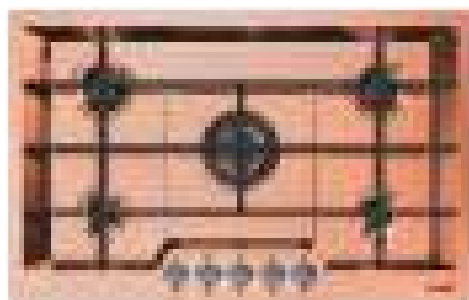

- AISI 304 Copper
- Dimensioni: **803x513**
- Griglie in ghisa e coprispartifiamma smaltati
- Accensione elettrica
- Valvolatura di sicurezza con termocoppia ad intervento rapido

- Potenza tot. 9.500 W
- ausiliario: 2x1.100 W
- semirapido: 2x1.750 W
- tripla corona: 3.800



Accessori: **2** (vedi pag. 401)

Disegno tecnico a pag. 430

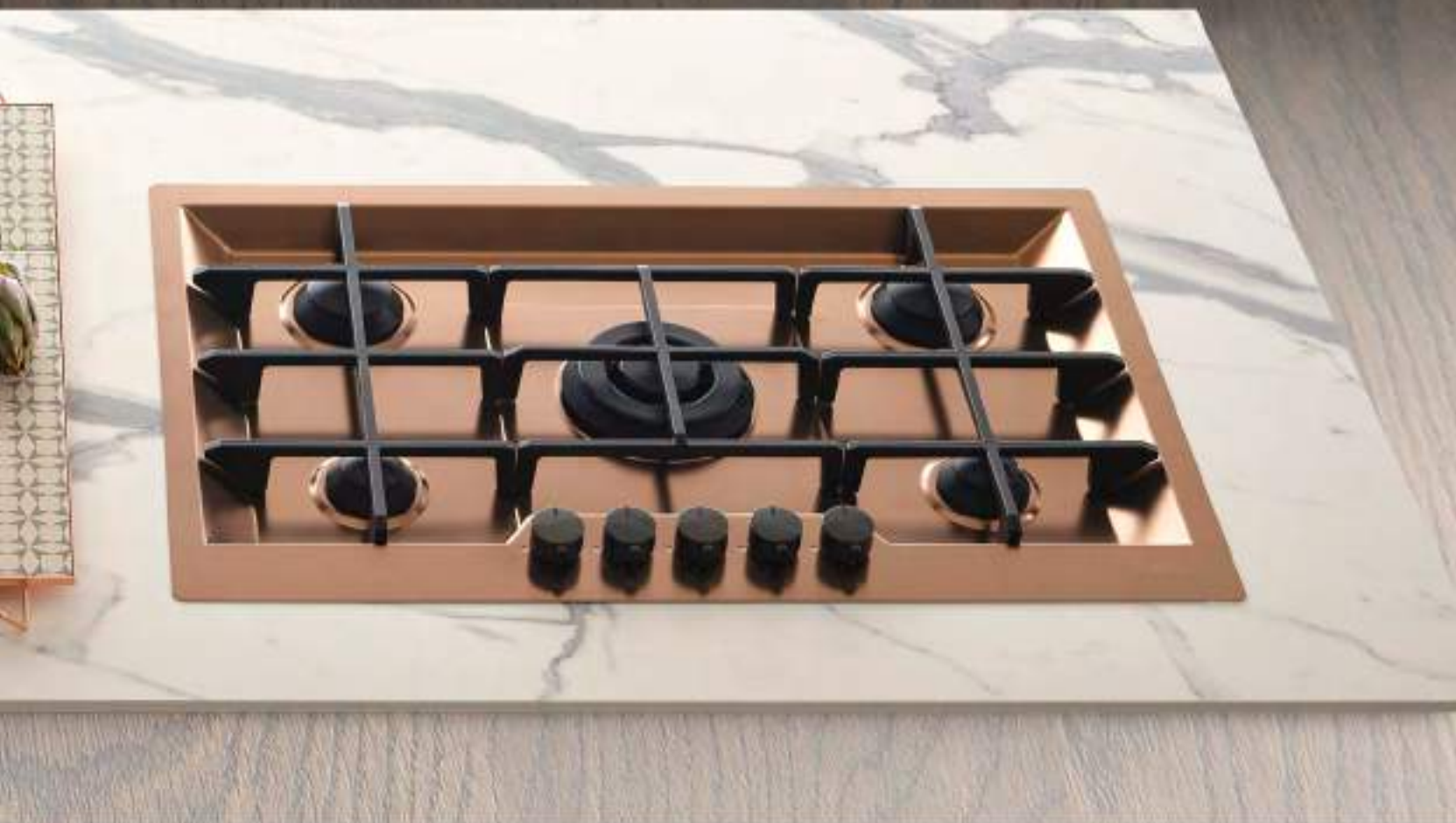

Copper

Portaprese



Codice

Prezzo

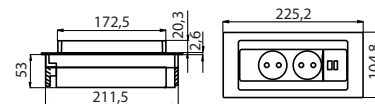
8000 118

Slot portaprese push in acciaio inox PVD Copper per incasso su piani da lavoro.
 2 prese schuko - 1 porta usb per ricarica.
 Foro incasso: **215 x 88**

PVD | Gold



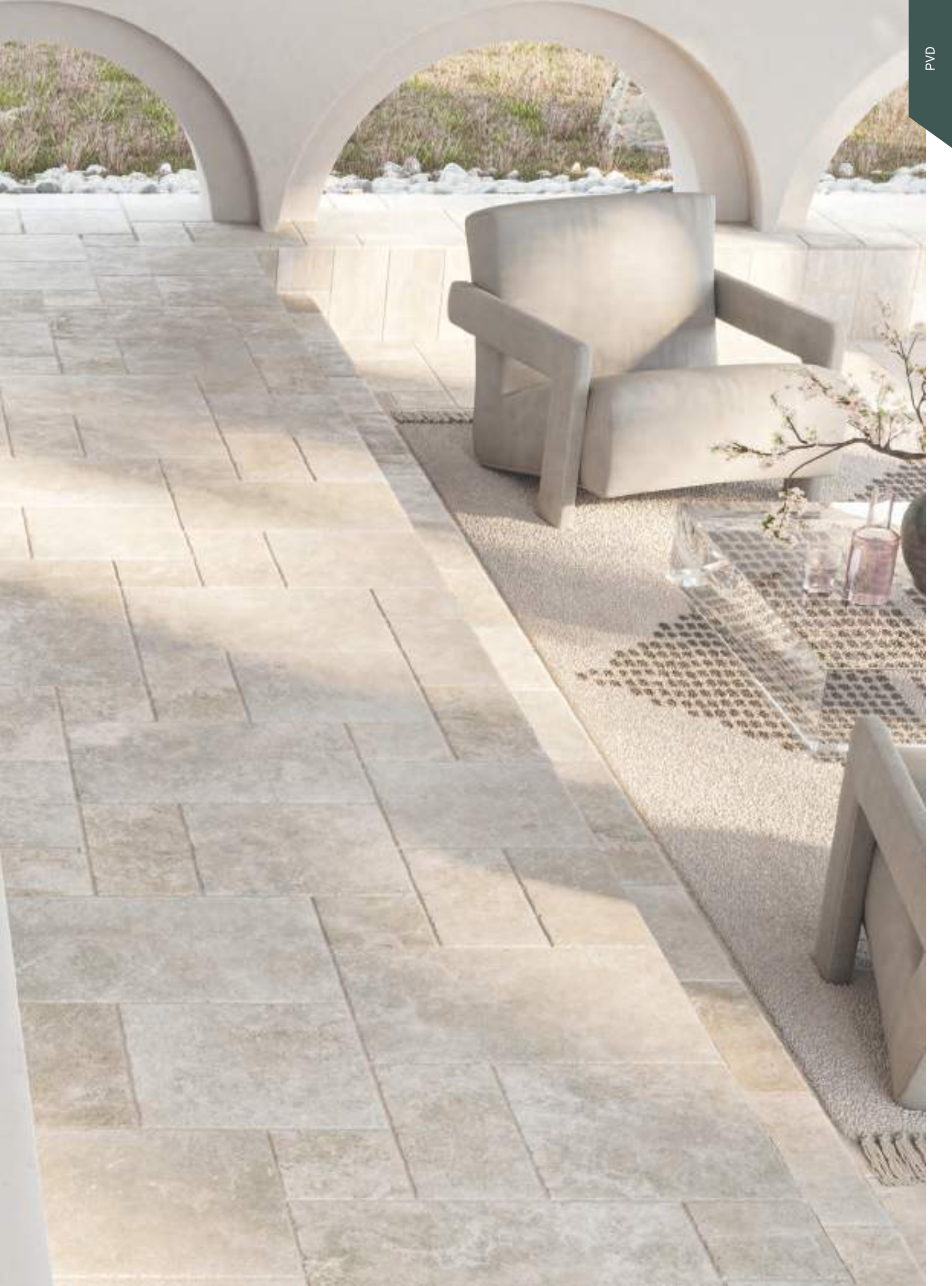

Base 80**5557 249****PB 20**

Per lastre spessore: 20 mm
 Dimensioni: **756 x 446**
 1 vasca: **716 x 406**

5557 349**PB 12**

Per lastre spessore: 12 mm
 Dimensioni: **740 x 430**
 1 vasca: **716 x 406**

- Incasso: vedi sito web
- Fondo in acciaio AISI 304 Gold
- Piletta 3½" + tubo corrugato universale per l'installazione di differente troppo pieno

Accessori, disegno tecnico a pag. 214

Pilette automatiche a pag. 70

Base 60**5555 249****PB 20**

Per lastre spessore: 20 mm
 Dimensioni: **546 x 446**
 1 vasca: **506 x 406**

5555 349**PB 12**

Per lastre spessore: 12 mm
 Dimensioni: **530 x 430**
 1 vasca: **506 x 406**

- Incasso: vedi sito web
- Fondo in acciaio AISI 304 Gold
- Piletta 3½" + tubo corrugato universale per l'installazione di differente troppo pieno

Accessori, disegno tecnico a pag. 214

Pilette automatiche a pag. 70

Base 60**5554 249****PB 20**

Per lastre spessore: 20 mm
 Dimensioni: **446 x 446**
 1 vasca: **406 x 406**

5554 349**PB 12**

Per lastre spessore: 12 mm
 Dimensioni: **430 x 430**
 1 vasca: **406 x 406**

- Incasso: vedi sito web
- Fondo in acciaio AISI 304 Gold
- Piletta 3½" + tubo corrugato universale per l'installazione di differente troppo pieno

Accessori, disegno tecnico a pag. 214

Pilette automatiche a pag. 70

| Base 80

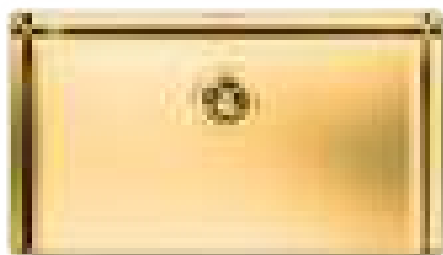
**4371 009**

— FT

incasso FT: vedi sito web*

— SPT

incasso SPT: 718 x 408 R16*

- Acciaio AISI 304 Gold
- Dimensioni: **726 x 416** - 1 vasca: **710 x 400**
- Piletta 3½"
- *Il foro incasso necessita di intaglio per l'alloggio del troppo pieno (vedi sito web)

Accessori, disegno tecnico a pag. 100
Pilette automatiche a pag. 70

| Base 80

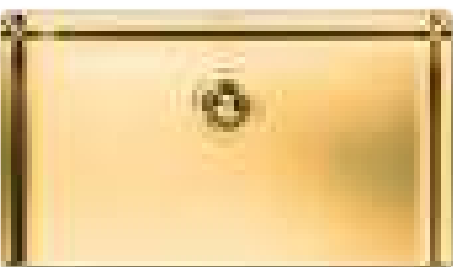
**4371 059**

— ST

incasso: vedi sito web

- Acciaio AISI 304 Gold
- Dimensioni: **726 x 416** - 1 vasca: **710 x 400**
- Piletta 3½"

Accessori, disegno tecnico a pag. 220
Pilette automatiche a pag. 70

| Base 60

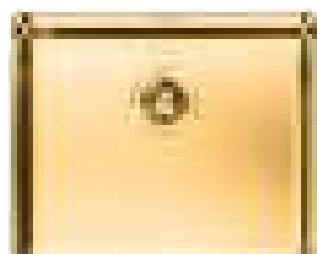
**4350 009**

— FT

incasso FT: vedi sito web*

— SPT

incasso SPT: 508 x 408 R16*

- Acciaio AISI 304 Gold
- Dimensioni: **516 x 416** - 1 vasca: **500 x 400**
- Piletta 3½"
- *Il foro incasso necessita di intaglio per l'alloggio del troppo pieno (vedi sito web)

Accessori, disegno tecnico a pag. 100
Pilette automatiche a pag. 70

Base 60**4350 059**— **ST**

incasso: vedi sito web

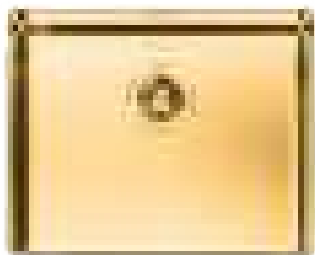

- Acciaio AISI 304 Gold
- Dimensioni: **516 x 416** - 1 vasca: **500 x 400**
- Piletta 3½"

Accessori, disegno tecnico a pag. 220
Pilette automatiche a pag. 70

Base 45**4340 009**— **FT**

incasso FT: vedi sito web*

— **SPT**

incasso SPT: 408 x 408 R16*

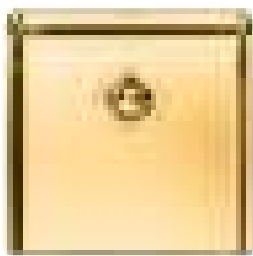

- Acciaio AISI 304 Gold
- Dimensioni: **416 x 416** - 1 vasca: **400 x 400**
- Piletta 3½"
- *Il foro incasso necessita di intaglio per l'alloggio del troppo pieno (vedi sito web)

Accessori, disegno tecnico a pag. 100
Pilette automatiche a pag. 70

Base 45**4340 059**— **ST**

incasso: vedi sito web

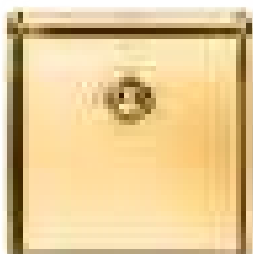

- Acciaio AISI 304 Gold
- Dimensioni: **416 x 416** - 1 vasca: **400 x 400**
- Piletta 3½"

Accessori, disegno tecnico a pag. 220
Pilette automatiche a pag. 70

Base 80



In dotazione: **2 griglie Black Milanello** (8100 602)
Accessori e disegno tecnico a pag. 106

1034 059

FT

incasso FT: vedi sito web

SPT

incasso SPT: 789 x 503

- Acciaio AISI 304 Gold
- Dimensioni: **806 x 520** - 1 vasca: **750 x 374**
- Piletta automatica Space Push (PD) 3 ½"
- Possibilità fori aggiuntivi
- Sistema a 3 invasi

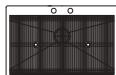

Configurazione
griglie Black
a filo vasca

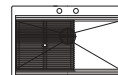

Configurazione
griglie Black
su fondo vasca

Base 90

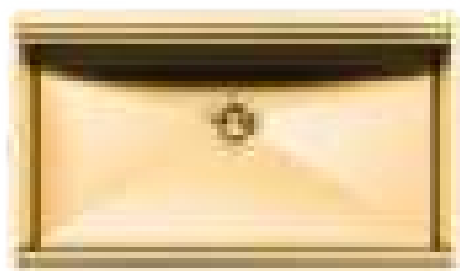

In dotazione: **2 griglie Black Milanello** (8100 602)
Accessori, disegno tecnico a pag. 226
Pilette automatiche a pag. 70

1034 859

ST

incasso: 750 x 426

- Acciaio AISI 304 Gold
- Dimensioni: **790 x 466** - 1 vasca: **750 x 374**
- Piletta SPACE 3 ½"
- Sistema a 3 invasi



Configurazione
griglie Black
a filo vasca

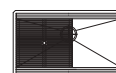

Configurazione
griglie Black
su fondo vasca

Base 80

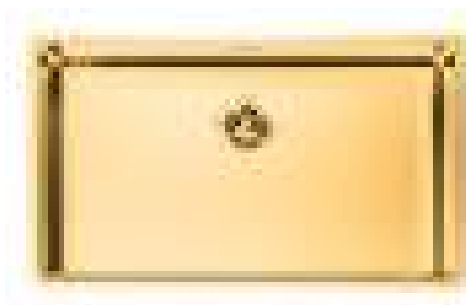

2157 059

FT

incasso FT: vedi sito web*

SPT

incasso SPT: 730 x 420*

- Acciaio AISI 304 Gold
- Dimensioni: **750 x 440** - 1 vasca: **710 x 400**
- Piletta 3½"

* Il foro incasso necessita di intaglio per l'alloggio del troppo-pieno (vedi sito web)

Accessori, disegno tecnico a pag. 162
Pilette automatiche a pag. 70

Base 80

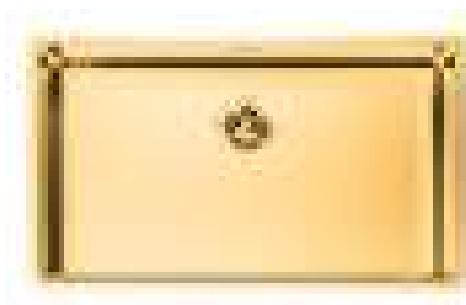

2157 859

ST

incasso: 710 x 400 R15

- Acciaio AISI 304 Gold
- Dimensioni: **750 x 440** - 1 vasca: **710 x 400**
- Piletta 3½"

• Disponibile anche in versione **Vintage**
2157 889



Accessori, disegno tecnico a pag. 270
Pilette automatiche a pag. 70

Base 60



2155 059

FT

incasso FT: vedi sito web*

SPT

incasso SPT: 520 x 420*

- Acciaio AISI 304 Gold
- Dimensioni: **540 x 440** - 1 vasca: **500 x 400**
- Piletta 3½"

* Il foro incasso necessita di intaglio per l'alloggio del troppo-pieno (vedi sito web)

Accessori, disegno tecnico a pag. 162
Pilette automatiche a pag. 70

Codice

Versione

Caratteristiche

Prezzo

Base 60

2155 859

ST

incasso: 500 x 400 R15

- Acciaio AISI 304 Gold
- Dimensioni: **540 x 440** - 1 vasca: **500 x 400**
- Piletta 3½"

- Disponibile anche in versione **Vintage**
2155 889



Accessori, disegno tecnico a pag. 270
Pilette automatiche a pag. 70

Base 60

2156 859

ST

incasso: 400 x 400 R15

- Acciaio AISI 304 Gold
- Dimensioni: **440 x 440** - 1 vasca: **400 x 400**
- Piletta 3½"

- Disponibile anche in versione **Vintage**
2156 889



Accessori, disegno tecnico a pag. 270
Pilette automatiche a pag. 70

Base 45**1130 069**

FT

incasso FT: vedi sito web*

SPT

incasso SPT: Ø 410*

- Acciaio AISI 304 Gold
- Dimensioni: Ø 425 - 1 vasca: Ø 380
- Piletta 3½"
- *Il foro di incasso necessita di intaglio per l'alloggio del troppo pieno

Accessori, disegno tecnico a pag. 132

Base 60**1130 869**

ST

incasso: Ø 380

- Acciaio AISI 304 Gold
- Dimensioni: Ø 425 - 1 vasca: Ø 380
- Piletta 3½"

Accessori, disegno tecnico a pag. 252

Accessori e pilette automatiche

Z7

Vaschetta forata inox
21,5x38 cm
8151 009

Da utilizzare abbinato a

N3 8644 101**K2** 8100 037**K1** 8100 627**PD****8407 121**

Piletta automatica **Space Push Gold** con comando remoto rotondo a pressione e con troppo/pieno perimetrale. Doppio tappo in dotazione: Space inox e "a cestello".

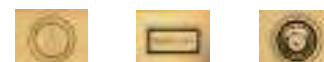





Caratteristiche

- Miscelatore monocomando
- Canna girevole e snodabile
- Base d'appoggio: Ø 50 mm

Codice

8424 859

Prezzo

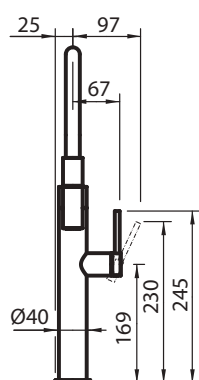
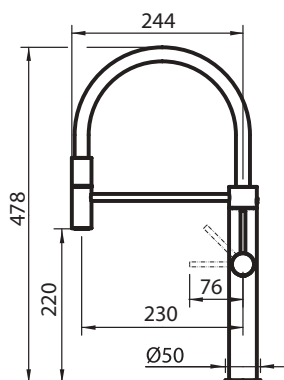

Caratteristiche





Caratteristiche

- Miscelatore monocomando
- Canna girevole e bocca estraibile
- Base d'appoggio: \varnothing 50 mm

Codice

8498 859

Prezzo

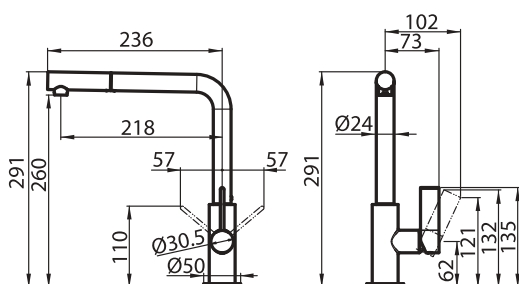
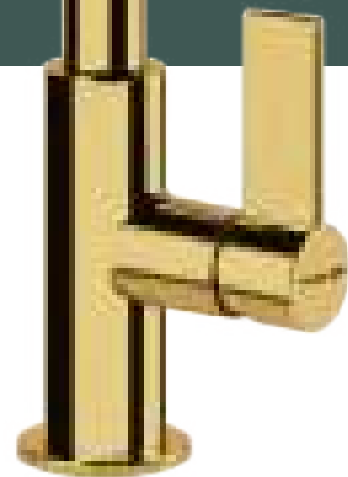

Funzioni





Caratteristiche

- Miscelatore monocomando
- Canna girevole
- Base d'appoggio: \varnothing 50 mm

Codice

8497 700

Prezzo

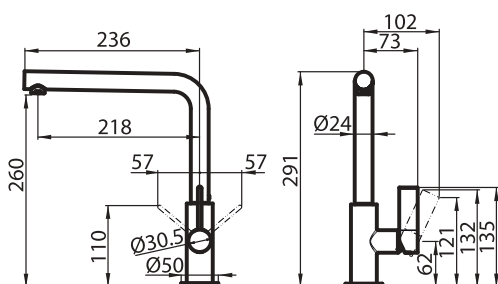
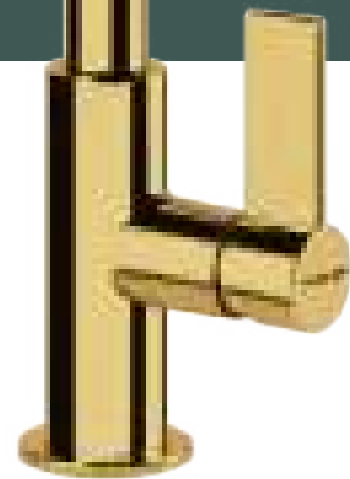

Funzioni





Caratteristiche

- Miscelatore monocomando
- Canna girevole a scomparsa up&down
- Base d'appoggio: \varnothing 55 mm

Codice

8524 009

Prezzo

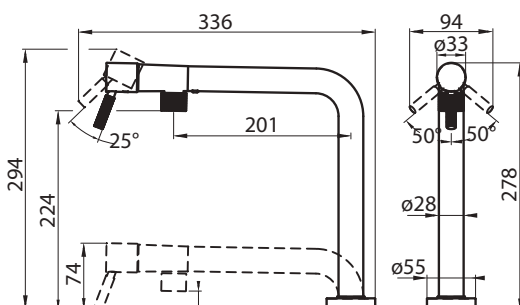
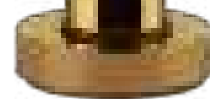

Funzioni





Accessori: **2** (vedi pag. 401)

Disegno tecnico a pag. 430

7682 009

FT

incasso FT: vedi sito web

SPT

incasso SPT: 790x500

- AISI 304 Gold
- Dimensioni: **803 x 513**
- Griglie in ghisa e coprispartifiamma smaltati
- Accensione elettrica
- Valvolatura di sicurezza con termocoppia ad intervento rapido
- Potenza tot. 10.250 W
ausiliario: 1.000 W
semirapido: 3x1.750 W
doppia corona: 4.000 W



Accessori: **2** (vedi pag. 401)

Disegno tecnico a pag. 430

7681 009

FT

incasso FT: vedi sito web

SPT

incasso SPT: 1098x459

- AISI 304 Gold
- Dimensioni: **1115 x 476**
- Griglie in ghisa e coprispartifiamma smaltati
- Accensione elettrica
- Valvolatura di sicurezza con termocoppia ad intervento rapido
- Potenza tot. 10.750 W
ausiliario: 1.000 W
semirapido: 1.750 W
rapido: 3.000 W
dual: 5.000 W



Accessori: **2** (vedi pag. 401)

Disegno tecnico a pag. 430

7680 009

FT

incasso FT: vedi sito web

SPT

incasso SPT: 853x459

- AISI 304 Gold
- Dimensioni: **870 x 476**
- Griglie in ghisa e coprispartifiamma smaltati
- Accensione elettrica
- Valvolatura di sicurezza con termocoppia ad intervento rapido
- Potenza tot. 7.750 W
ausiliario: 1.000 W
semirapido: 1.750 W
dual: 5.000 W

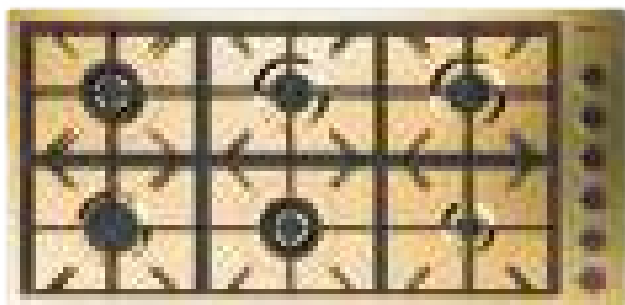

In dotazione: 2x **2** (vedi pag. 401)

Disegno tecnico a pag. 430

7639 009

FT

incasso FT: vedi sito web

SPT

incasso SPT: 1134x540

- AISI 304 Gold
- Dimensioni: **1154x560**
- Griglie in ghisa e coprispartifiamma smaltati
- Accensione elettrica
- Valvolatura di sicurezza con termocoppia ad intervento rapido

- Potenza tot. 15.900 W
- ausiliario: 1.000 W
- semirapido: 2x1.750 W
- rapido: 3.000 W
- dual: 2x4.200 W

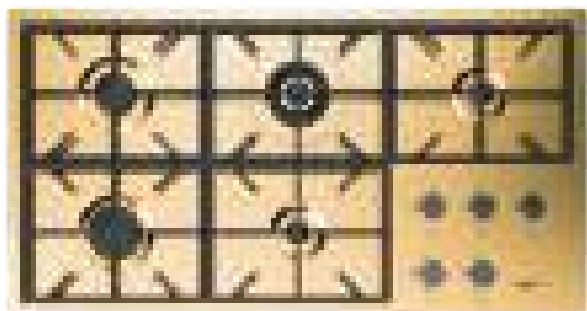

In dotazione: **2** (vedi pag. 401)

Disegno tecnico a pag. 430

7638 009

FT

incasso FT: vedi sito web

SPT

incasso SPT: 1036x540

- AISI 304 Gold
- Dimensioni: **1056x560**
- Griglie in ghisa e coprispartifiamma smaltati
- Accensione elettrica
- Valvolatura di sicurezza con termocoppia ad intervento rapido

- Potenza tot. 10.950 W
- ausiliario: 2x1.000 W
- semirapido: 1.750 W
- rapido: 3.000 W
- dual: 4.200 W

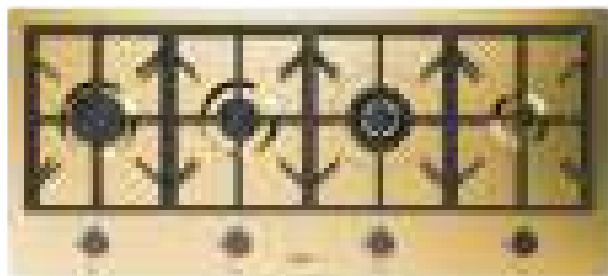

In dotazione: **2** (vedi pag. 401)

Disegno tecnico a pag. 430

7640 009

FT

incasso FT: vedi sito web

SPT

incasso SPT: 1060x470

- AISI 304 Gold
- Dimensioni: **1080x490**
- Griglie in ghisa e coprispartifiamma smaltati
- Accensione elettrica
- Valvolatura di sicurezza con termocoppia ad intervento rapido

- Potenza tot. 9.950 W
- ausiliario: 1.000 W
- semirapido: 1.750 W
- rapido: 3.000 W
- dual: 4.200 W



Gold

KE

Codice

Versione

Caratteristiche

Prezzo

7601 932

FT

incasso FT: vedi sito web

SPT

incasso SPT: 790x500

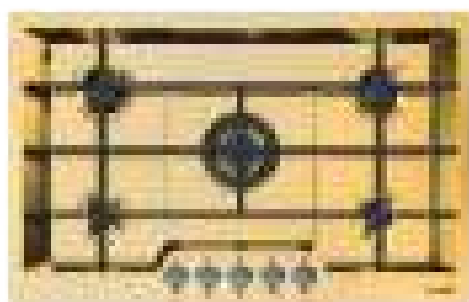

- AISI 304 Gold
- Dimensioni: **803x513**
- Griglie in ghisa e coprispartifiamma smaltati
- Accensione elettrica
- Valvolatura di sicurezza con termocoppia ad intervento rapido

- Potenza tot. 9.500 W
- ausiliario: 2x1.100 W
- semirapido: 2x1.750 W
- triplo corona: 3.800



Accessori: **2** (vedi pag. 401)

Disegno tecnico a pag. 430



Gold

Portaprese

Codice

Prezzo

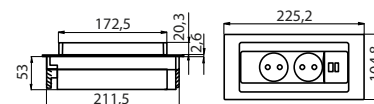
8000 119

Slot portaprese push in acciaio inox PVD Gold per incasso su piani da lavoro.
 2 prese schuko - 1 porta usb per ricarica.
 Foro incasso: **215 x 88**

PVD | Brandy





Quadra R12



Base 80

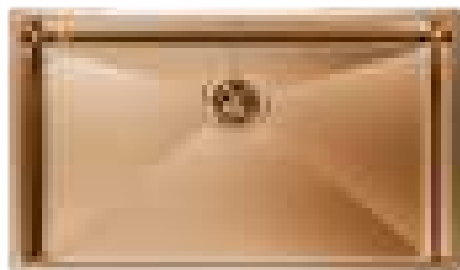

In dotazione: **1 griglia** (8100 617)
 Accessori, disegno tecnico a pag. 124
 Piletta automatica Cod. 8407122

Codice	Versione	Caratteristiche	Prezzo
--------	----------	-----------------	--------

1717 055

FT

incasso FT: vedi sito web*

SPT

incasso SPT: 730 x 430*

- Acciaio AISI 304 Brandy
- Dimensioni: **750 x 440** - 1 vasca: **710 x 400**
- Piletta 3,5" Copper
- *Il foro necessita di intaglio per l'alloggio del troppo-pieno (solo per top >30)

- Disponibile anche in versione **Brandy Fumè**
1717 015

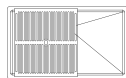

Configurazione
 griglie Black
 a filo vasca



Configurazione
 griglie Black
 su fondo vasca

Base 80**1717 855****ST**

incasso: 710 x 400 R12

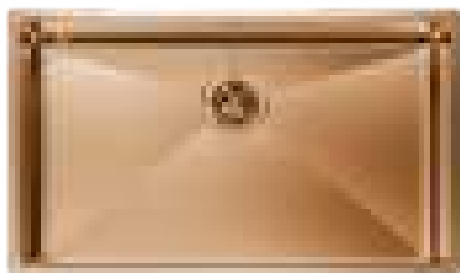

- Acciaio AISI 304 Brandy
- Dimensioni: **750 x 440** - 1 vasca: **710 x 400**
- Piletta 3,5" Copper

- Disponibile anche in versione **Brandy Fumè**
1717 815



In dotazione: **1 griglia** (8100 617)
Accessori, disegno tecnico a pag. 244
Piletta automatica Cod. 8407122

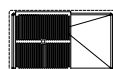

Configurazione
griglie Black
a filo vasca

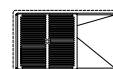

Configurazione
griglie Black
su fondo vasca

Base 60**1715 055****FT**

incasso FT: vedi sito web*

SPT

incasso SPT: 520 x 430*



- Acciaio AISI 304 Brandy
- Dimensioni: **540 x 440** - 1 vasca: **500 x 400**
- Piletta 3,5" Copper
- *Il foro necessita di intaglio per l'alloggio del troppo-pieno (solo per top >30)

- Disponibile anche in versione **Brandy Fumè**
1715 015



In dotazione: **1 griglia** (8100 617)
Accessori, disegno tecnico a pag. 124
Piletta automatica Cod. 8407122



Configurazione
griglie Black
a filo vasca



Configurazione
griglie Black
su fondo vasca

Base 60**1715 855****ST**

incasso: 500 x 400 R12



- Acciaio AISI 304 Brandy
- Dimensioni: **540 x 440** - 1 vasca: **500 x 400**
- Piletta 3,5" Copper

- Disponibile anche in versione **Brandy Fumè**
1715 815



In dotazione: **1 griglia** (8100 617)
Accessori, disegno tecnico a pag. 244
Piletta automatica Cod. 8407122



Configurazione
griglie Black
a filo vasca



Configurazione
griglie Black
su fondo vasca



Base 80

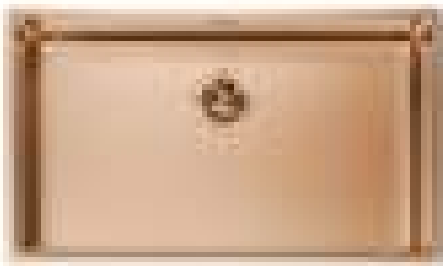

Accessori, disegno tecnico a pag. 162
Piletta automatica Cod. 8407122

Codice	Versione	Caratteristiche	Prezzo
2157 055	FT	incasso FT: vedi sito web*	
	SPT	incasso SPT: 730 x 420*	

- Acciaio AISI 304 Brandy
- Dimensioni: **750 x 440** - 1 vasca: **710 x 400**
- Piletta 3,5" Copper

* Il foro incasso necessita di intaglio per l'alloggio del troppo-pieno (vedi sito web)

Base 80

2157 855

ST

incasso: 710 x 400 R15



- Acciaio AISI 304 Brandy
- Dimensioni: **750 x 440** - 1 vasca: **710 x 400**
- Piletta 3,5" Copper

Accessori, disegno tecnico a pag. 270
Piletta automatica Cod. 8407122

Base 60

2155 055

FT

incasso FT: vedi sito web*

SPT

incasso SPT: 520 x 420*

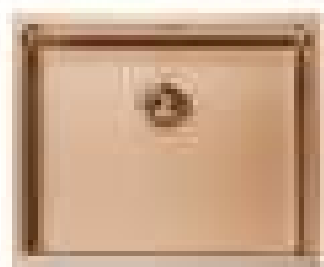

- Acciaio AISI 304 Brandy
- Dimensioni: **540 x 440** - 1 vasca: **500 x 400**
- Piletta 3,5" Copper

* Il foro incasso necessita di intaglio per l'alloggio del troppo-pieno
(vedi sito web)

Accessori, disegno tecnico a pag. 162
Piletta automatica Cod. 8407122

Base 60

2158 855

ST

incasso: 500 x 400 R15



- Acciaio AISI 304 Brandy
- Dimensioni: **540 x 440** - 1 vasca: **500 x 400**
- Piletta 3,5" Copper

Accessori, disegno tecnico a pag. 270
Piletta automatica Cod. 8407122

PVD | Sunset







Caratteristiche

- Miscelatore monocomando
- Canna girevole e snodabile
- Base d'appoggio: Ø 50 mm

Codice

8424 851

Prezzo

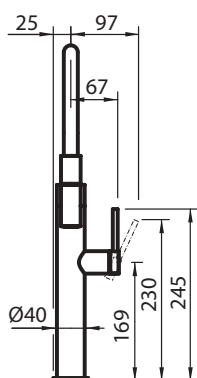
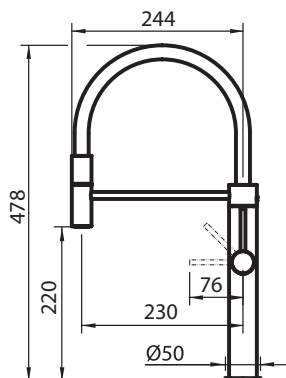

Caratteristiche



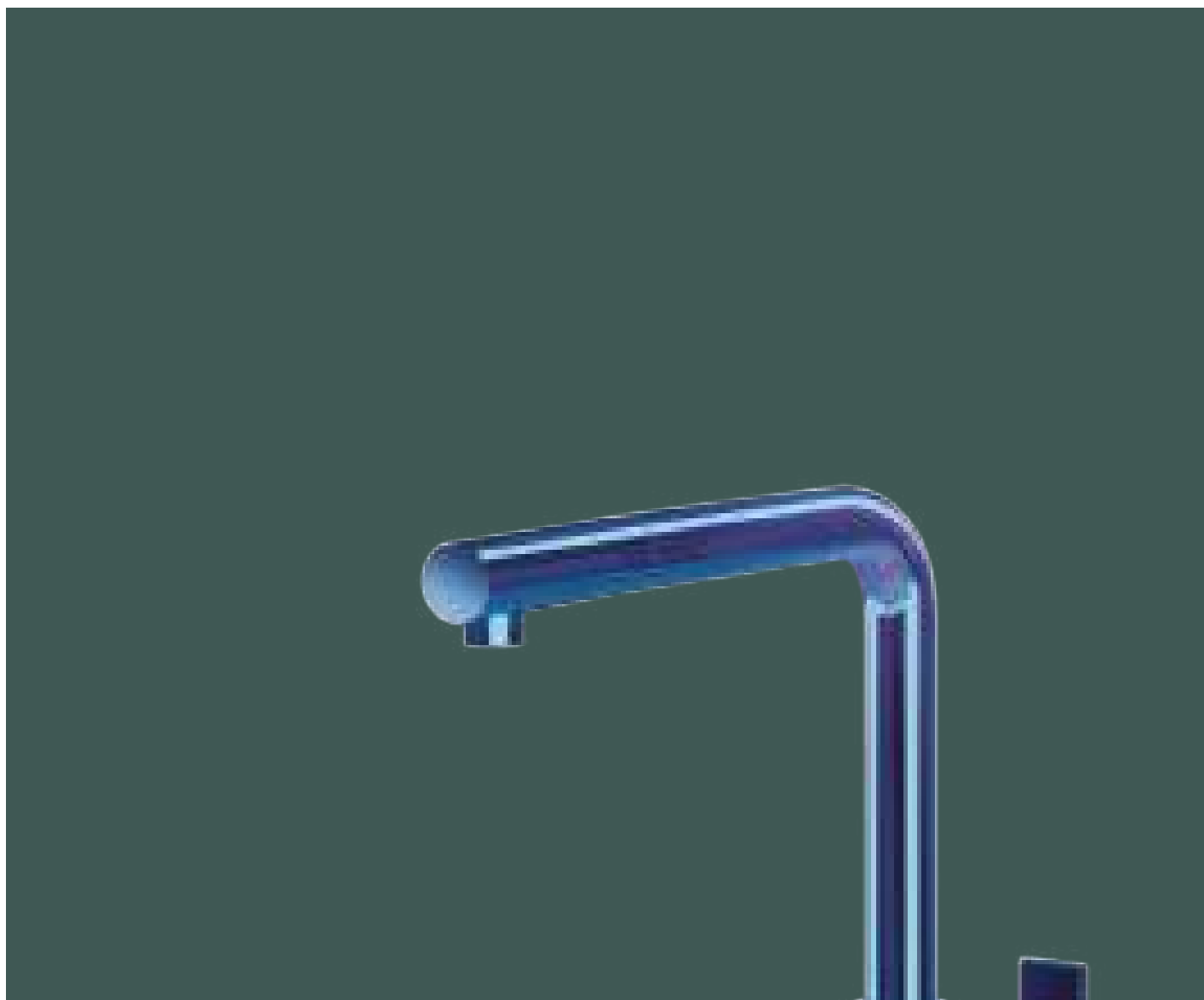

Caratteristiche

- Miscelatore monocomando
- Canna girevole e bocca estraibile
- Base d'appoggio: \varnothing 50 mm

Codice

8498 851

Prezzo

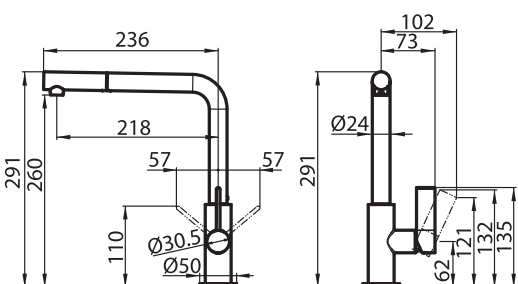

Funzioni



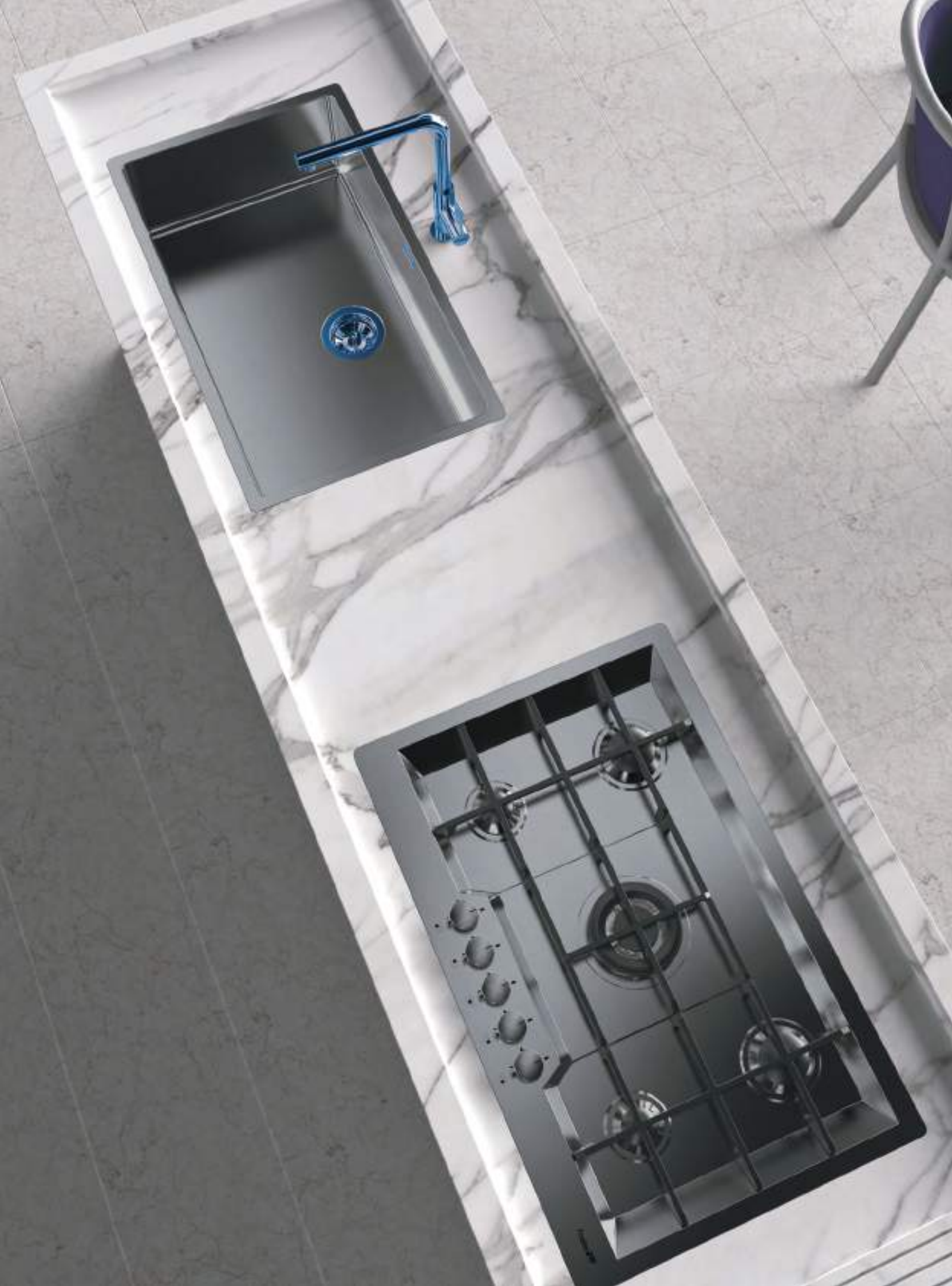

Sunset

Piletta 3"½ **NEW**

PVD



8403 325

Piletta troppo pieno a mostrina 3,5" Sunset



Il PVD Sunset è il nuovo arrivato nella gamma PVD Foster

Il PVD Sunset è caratterizzato da una colorazione cangiante e iridescente che disegna sfumature che vanno dall'azzurro al viola, come i tramonti più intensi.













Lavelli | Soprato







96	Phantom 	154	KE 
102	Milanello workstation	164	Stripe
108	Foster Milano	168	Serie EVO 
114	Quadra EVO 	174	Elettra
120	Quadra R12 	178	FM
126	Quadra 	180	FM Marine
132	Circolari 	184	Big Bowl
134	S4001 	188	Uragano
142	New Wave	189	Tornado
146	Fortyfour	192	Angolare 
148	Master	196	S1000
152	FL	202	Monovasca S1000 

Phantom
sopratop | filotop

NEW



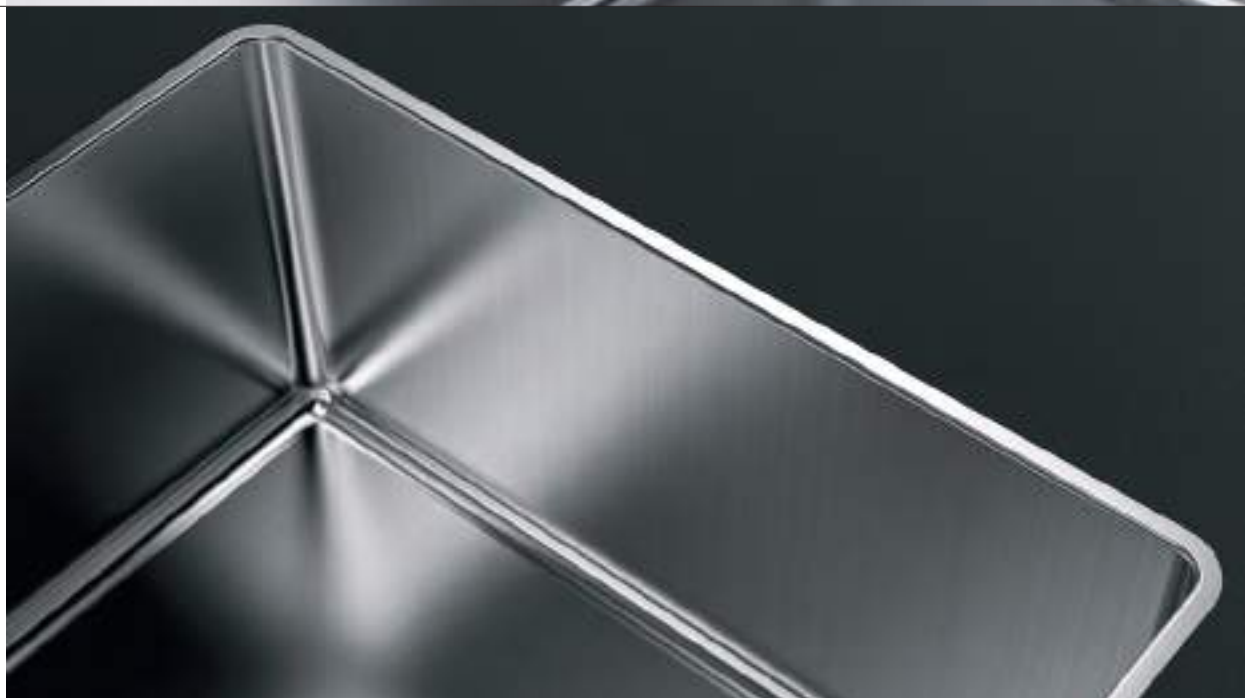

Il bordo sottile

quasi invisibile crea un senso di continuità con il top donando eleganza e design

Lavelli con vasche R12

Base 80



Accessori, disegno tecnico e pilette automatiche a pag. 100

4371 001

FT

incasso FT: vedi sito web*

SPT

incasso SPT: 718 x 408 R16*

- Acciaio AISI 304 satinato
- Dimensioni: **726 x 416** - 1 vasca: **710 x 400**
- Piletta 3½"
- *Il foro incasso necessita di intaglio per l'alloggio del troppo pieno (vedi sito web)

• Disponibile anche in versione **PVD**

Gun Metal
4371 006



pag. 23

Copper
4371 008



pag. 47

Gold
4371 009



pag. 65

Base 60



Accessori, disegno tecnico e pilette automatiche a pag. 100

4350 001

FT

incasso FT: vedi sito web*

SPT

incasso SPT: 508 x 408 R16*

- Acciaio AISI 304 satinato
- Dimensioni: **516 x 416** - 1 vasca: **500 x 400**
- Piletta 3½"
- *Il foro incasso necessita di intaglio per l'alloggio del troppo pieno (vedi sito web)

• Disponibile anche in versione **PVD**

Gun Metal
4350 006



pag. 23

Copper
4350 008



pag. 47

Gold
4350 009



pag. 65

Base 45



Accessori, disegno tecnico e pilette automatiche a pag. 100

4340 001

FT

incasso FT: vedi sito web*

SPT

incasso SPT: 408 x 408 R16*

- Acciaio AISI 304 satinato
- Dimensioni: **416 x 416** - 1 vasca: **400 x 400**
- Piletta 3½"
- *Il foro incasso necessita di intaglio per l'alloggio del troppo pieno (vedi sito web)

• Disponibile anche in versione **PVD**

Gun Metal
4340 006



pag. 24

Copper
4340 008



pag. 48

Gold
4340 009



pag. 66



* Bordo sottile di soli 8 mm

B3

Griglia Black
39 x 42 cm
8100 617



B8

Griglia Black
38 x 69 cm
8100 653



B6

Griglia Black
38 x 38 cm
8100 651



B7

Griglia Black
38 x 48 cm
8100 652



K7

Kit tagliere in legno
Iroko 42 x 31,7 cm
con vaschetta
scolapasta
in acciaio inox
8644 044



L4

Tagliere cristallo
23x41 cm
8631 300



N2

Tagliere in HDPE
27,2x42,5 cm
8657 001



N3

Tagliere Twin
in HDPE 31,7x41,8
8644 101



O2

Vaschetta bianca
27,2x41,4 cm
8153 100



K8 *

Kit grattugie con
anello-supporto e
vaschetta vivande
8159 101



R2

Cestello Inox
34x40 cm
8611 000



R3

Cestello Inox
40x40
8612 000



T1

Cestello portapiatti
inox 25x42,5 cm
8100 201



T2 *

Cestello portapiatti
inox 21,4x37,9 cm
8100 303



Z2 *

Vaschetta forata
inox 21,5x38 cm
8151 000



Disponibile anche in versione PVD



Gun Metal
8151 006



Copper
8151 008



Gold
8151 009

4371 001 **B3 B8 K7 L4 N2 N3 O2 K8**
R2 R3 T1 T2 Z2

4350 001 **B3 K7 L4 N2 N3 O2 K8 R2**
R3 T1 T2 Z2 B7

4340 001 **B3 K7 L4 N2 N3 O2 K8 R2**
R3 T1 T2 Z2 B6

pilette automatiche opzionali

4371 001 **PL PP PA PE PM**

4350 001 **PL PP PA PE PM**

4340 001 **PL PP PA PE PM**

Vedi pag. 298

* utilizzabile solo in abbinamento al tagliere N3

4371 001

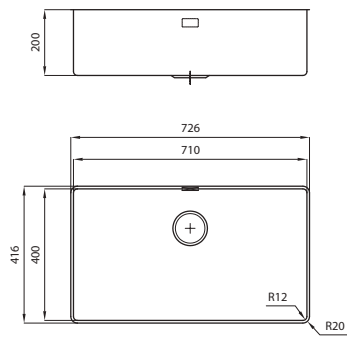

4350 001

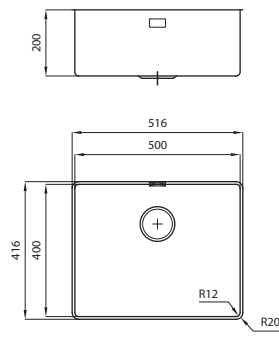

4340 001

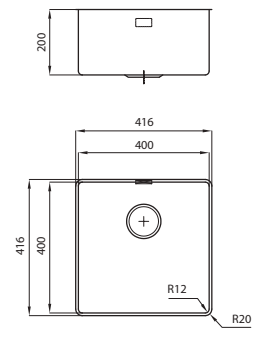

Milanello workstation
sopratop | filotop



archiproducts®
DESIGN AWARDS
—
WINNER 2019





Sistema a tre invasi

Sul primo scorrone le griglie Black: una grande superficie per risciacquare, scolare, lavorare.



Gamma completa di accessori scorrevoli

Sul secondo invaso una combinazione di accessori per rendere pratica ogni operazione: risciacquare, scolare, affettare, grattugiare... sempre all'interno del lavello.



Griglia di protezione sul fondo

Il terzo invaso per le griglie black è sul fondo della vasca. Per risciacquare senza venire a contatto con il fondo, o per appoggiare senza graffiare l'acciaio.



Milanello workstation

sopratop | filotop

Codice

Versione

Caratteristiche

Prezzo

Base 120



In dotazione: **3 griglie Black Milanello** (8100 602)

Accessori e disegno tecnico a pag. 106

In foto versione sinistra

1043 051 dx

FT

incasso FT: vedi sito web

1043 052 sx

SPT

incasso SPT: 1158 x 503

- Acciaio AISI 304 satinato
- Dimensioni: **1175 x 520** - 1 vasca: **855 x 374**
- Piletta automatica Space Push (PP) 3 1/2"
- Possibilità fori aggiuntivi
- Sistema a 3 invasi

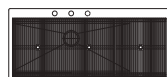

Configurazione griglie Black a filo vasca



Configurazione griglie Black su fondo vasca

Base 80



In dotazione: **2 griglie Black Milanello** (8100 602)

Accessori e disegno tecnico a pag. 106

In foto versione sinistra

1040 051 dx

FT

incasso FT: vedi sito web

1040 052 sx

SPT

incasso SPT: 789 x 503

- Acciaio AISI 304 satinato
- Dimensioni: **806 x 520** - 1 vasca: **430 x 374**
- Piletta automatica Space Push (PP) 3 1/2"
- Possibilità fori aggiuntivi
- Sistema a 3 invasi

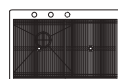

Configurazione griglie Black a filo vasca

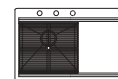

Configurazione griglie Black su fondo vasca

Base 80



In dotazione: **2 griglie Black Milanello** (8100 602)

Accessori e disegno tecnico a pag. 106

1034 050

FT

incasso FT: vedi sito web

SPT

incasso SPT: 789 x 503

- Acciaio AISI 304 satinato
- Dimensioni: **806 x 520** - 1 vasca: **750 x 374**
- Piletta automatica Space Push (PP) 3 1/2"
- Possibilità fori aggiuntivi
- Sistema a 3 invasi

• Disponibile anche in versione **PVD**

Gun Metal
1034 056



pag. 25

Copper
1034 058



pag. 49

Gold
1034 059



pag. 67

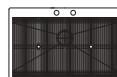

Configurazione griglie Black a filo vasca

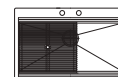

Configurazione griglie Black su fondo vasca

Milanello workstation

sopratop | filotop

Codice

Versione

Caratteristiche

Prezzo

1031 050

FT

incasso FT: vedi sito web

SPT

incasso SPT: 469 x 503

- Acciaio AISI 304 satinato
- Dimensioni: **486 x 520** - 1 vasca: **430 x 374**
- Piletta automatica Space Push (PP) 3 1/2"
- Sistema a 3 invasi



In dotazione: **1 griglia Black Milanello** (8100 602)
Accessori e disegno a pag. 106



Configurazione
griglia Black
a filo vasca



Configurazione
griglia Black
su fondo vasca

Milanello workstation | accessori

accessori opzionali scorrevoli sotto le griglie



Z3

Vaschetta forata
inox 21,5x40 cm
8156 000

LIV. 2



T8

Griglia portapiatti
inox 21,4x37,2 cm
8100 306

LIV. 2



P2

Tagliere
39,5 x 22,5 cm
in legno noce
8642 004

LIV. 2

altri accessori opzionali



L4

Tagliere cristallo
23x41 cm
8631 300

LIV. 1



N2

Tagliere in HDPE
27,2x42,5 cm
8657 001

LIV. 1



N3

Tagliere Twin
in HDPE 31,7x41,8
8644 101

LIV. 1



K8 *

Kit grattugie con
anello-supporto e
vaschetta vivande
8159 101

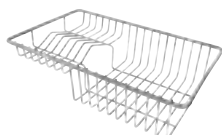

T2 *

Cestello portapiatti
inox 21,4x37,9 cm
8100 303



Z2 *

Vaschetta forata
inox 21,5x38 cm
8151 000

Disponibile anche in versione PVD



Gun Metal
8151 006



Copper
8151 008



Gold
8151 009



K7

Kit tagliere in legno
Iroko 42 x 31,7 cm
con vaschetta
scolapasta
in acciaio inox
8644 044

LIV. 1



B5

Griglia Black
37,2 x 42,4 cm
8100 602

LIV. 1 - 3

(in dotazione)

1043 051 Z3 T8 L5 N2 N3 K8 T2 Z2
1043 052 K7 P2 B5

1040 051 Z3 T8 L5 N2 N3 K8 T2 Z2
1040 052 K7 P2 B5

1034 050 Z3 T8 L5 N2 N3 K8 T2 Z2
K7 P2 B5

1031 050 Z3 T8 L5 N2 N3 K8 T2 Z2
K7 P2 B5

* utilizzabile solo in abbinamento agli accessori N3, K1 e K2

1043 051 dx | 1043 052 sx

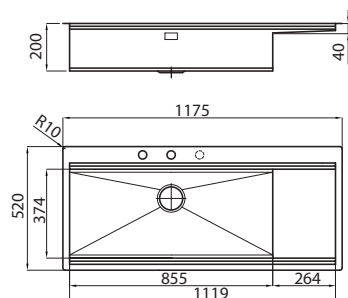

1040 051 dx | 1040 052 sx

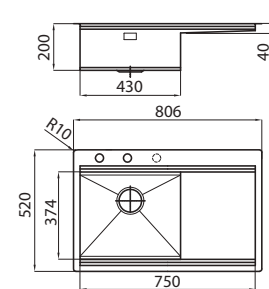

1034 050

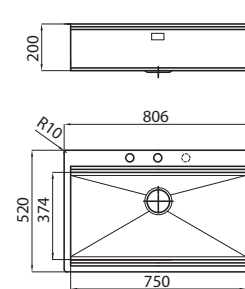

1031 050

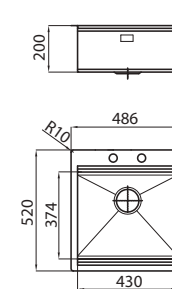

Schema di posizionamento degli accessori sugli invasi

Il sistema di "corsie" rende possibile l'utilizzo combinato di innumerevoli accessori. Griglie, taglieri, portautensili, vaschette e contenitori di varie dimensioni si alternano nella zona di lavoro con un semplice gesto e possono essere impilati, sempre a portata di mano.

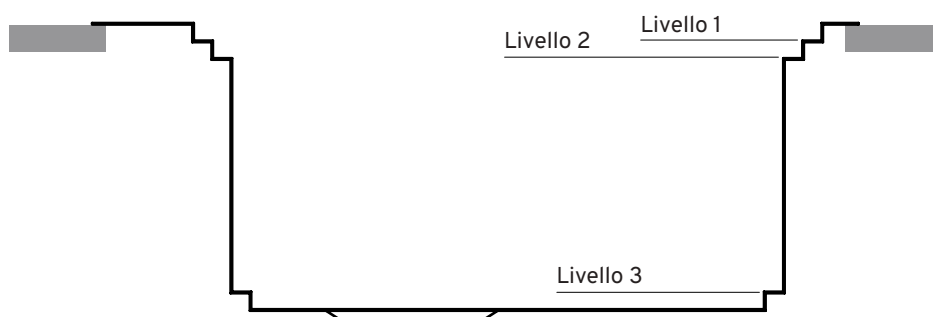

Foster Milano
sopratop | filotop | Q4





Ampia vasca con sistema a tre invasi:
Tutto lo spazio che serve come lavello o area di lavoro



Gamma completa di accessori scorrevoli



Griglia di protezione sul fondo



Foster Milano

sopratop | filotop | Q4

Base 120



In dotazione elemento portacottelli
Accessori e disegno tecnico a pag. 112

Codice

Versione

Caratteristiche

Prezzo

1018 055



incasso Q4: 1004 x 540

1017 055



incasso FT: vedi sito web



incasso SPT: 1004 x 540

- Acciaio AISI 304 satinato
- Dimensioni: **1024 x 560** - 1 vasca: **968 x 400**
- Piletta automatica Space Milano 3½"
- Sistema a 3 invasi
- Possibilità fori aggiuntivi

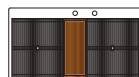

Configurazione
griglie Black
a filo vasca



Configurazione
griglie Black
su fondo vasca

Base 120



Accessori e disegno tecnico a pag. 112

1018 050



incasso Q4: 1004 x 540

1017 050



incasso FT: vedi sito web



incasso SPT: 1004 x 540

- Acciaio AISI 304 satinato
- Dimensioni: **1024 x 560** - 1 vasca: **968 x 400**
- Piletta automatica Space Milano 3½"
- Sistema a 3 invasi
- Possibilità fori aggiuntivi

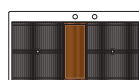

Configurazione
griglie Black
a filo vasca



Configurazione
griglie Black
su fondo vasca

Base 90



Accessori e disegno tecnico a pag. 112

1025 050



incasso Q4: 826 x 540

1024 050



incasso FT: vedi sito web



incasso SPT: 826 x 540

- Acciaio AISI 304 satinato
- Dimensioni: **846 x 560** - 1 vasca: **790 x 400**
- Piletta automatica Space Milano 3½"
- Sistema a 3 invasi
- Possibilità fori aggiuntivi

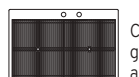

Configurazione
griglie Black
a filo vasca



Configurazione
griglie Black
su fondo vasca

Foster Milano

sopratop | filotop | Q4

Base 60



Accessori e disegno tecnico a pag. 112

Codice	Versione	Caratteristiche	Prezzo
1012 050	Q4	incasso Q4: 498 x 540	
1011 050	FT SPT	incasso FT: vedi sito web incasso SPT: 498 x 540	

- Acciaio AISI 304 satinato
- Dimensioni: **518 x 400** - 1 vasca: **462 x 400**
- Piletta automatica Space Milano 3½"
- Sistema a 3 invasi



Configurazione
griglie Black
a filo vasca



Configurazione
griglie Black
su fondo vasca



L4

Tagliere cristallo
23 x 41 cm
8631 300

LIV. 2



P6

Tagliere legno noce
18 x 44 cm
8642 000

LIV. 1



N3

Tagliere Twin
in HDPE
31,7 x 41,8 cm
8644 101

LIV. 2



K8 *

Kit grattugie con anello
supporto e vaschetta
raccolgi vivande
8159 101

LIV. 2

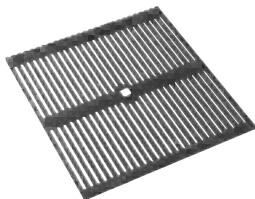

B9

Griglia Black
39,2 x 44,8 cm
8100 600

LIV. 1 - 3



T2 *

Cestello portapiatti
Inox 21,4 x 37,9 cm
8100 303

LIV. 2



Z2 *

Vaschetta forata
Inox 21,5 x 38 cm
8151 000

LIV. 2

Disponibile anche in versione **PVD**



Gun Metal
8151 006



Copper
8151 008



Gold
8151 009



O2

Vaschetta bianca
41,4x27,2 cm
8153 100



K7

Kit tagliere in legno
Iroko 42 x 31,7 cm
con vaschetta
scolapasta in acciaio
inox
8644 044

LIV. 2



K3

Kit porta spezie
44,8 x 10 cm
8100 620

LIV. 1



K4

Kit porta bottiglie
44,8 x 14 cm
8100 621

LIV. 1



K5

Kit vaschette
44,8 x 18 cm
8100 622

LIV. 1

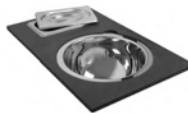

K6

Kit vaschetta+ bowl
44,8 x 28 cm
8100 628

LIV. 1



K2

Kit tagliere
44,8 x 28,9 cm
8100 037

LIV. 1



X1 **

Vaschetta inox forata
12,6 x 12,1 cm
8151 001



X3 ***

Porta coltelli
8100 030

1017 055 **P6 B9 L4 N3 K8 T2 Z2 O2**
K2 K3 K4 K5 K6 K7 X1 X3

1017 050 **P6 B9 L4 N3 K8 T2 Z2 O2**
K2 K3 K4 K5 K6 K7 X1 X3

1024 050 **P6 B9 L4 N3 K8 T2 Z2 O2**
K2 K3 K4 K5 K6 K7 X1 X3

1011 050 **P6 B9 L4 N3 K8 T2 Z2 O2**
K2 K3 K4 K5 K6 K7 X1 X3

* utilizzabile solo in abbinamento al tagliere N3
** utilizzabile solo in abbinamento al kit K2
*** utilizzabile solo in abbinamento al kit K4

1017 055

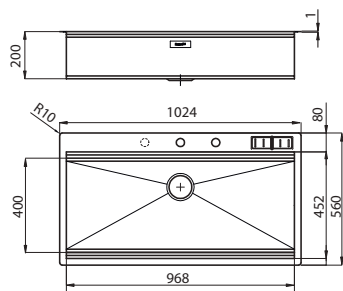

1017 050

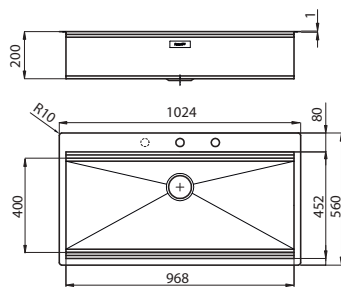

1024 050

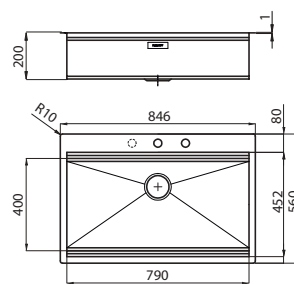

1011 050

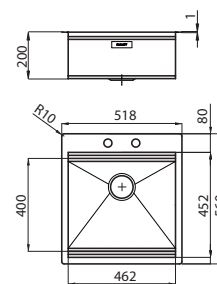

1018 055

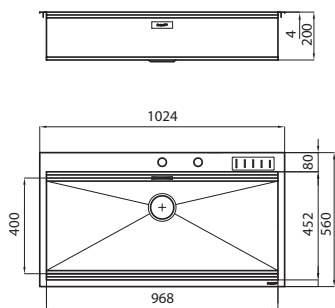

1018 050

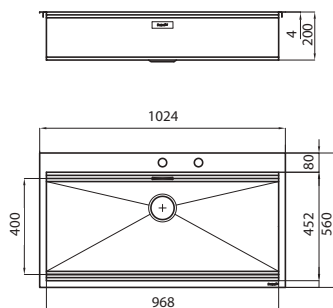

1025 050

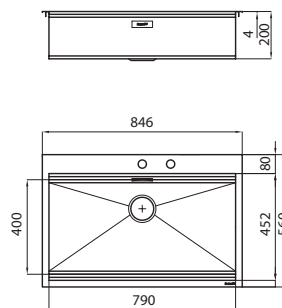

1012 050

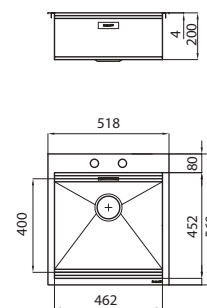

Schema di posizionamento degli accessori sugli invasi

Il sistema di "corsie" rende possibile l'utilizzo combinato di innumerevoli accessori. Griglie, taglieri, portautensili, vaschette e contenitori di varie dimensioni si alternano nella zona di lavoro con un semplice gesto e possono essere impilati, sempre a portata di mano.

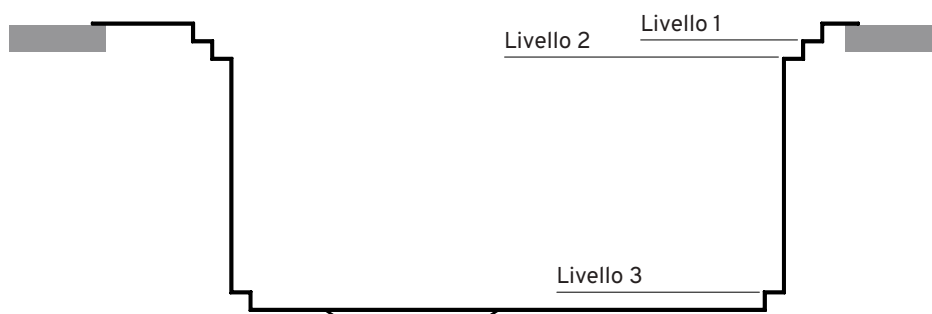

Quadra EVO NEW
sopratop | filotop





Gamma completa di accessori



Griglia di protezione sul fondo

Sul fondo le griglie appoggiano su un gradino perimetrale per risciacquare senza venire a contatto col fondo o per appoggiare senza graffiare l'acciaio.



Griglia in dotazione



Quadra EVO

sopratop | filotop



Codice	Versione	Caratteristiche	Prezzo
--------	----------	-----------------	--------

Base 80



In dotazione: **2 griglie** (8100 614 - 8100 615)
 Accessori, disegno tecnico
 e pilette automatiche a pag. 118

1257 050	FT	incasso FT: vedi sito web*
	SPT	incasso SPT: 760 x 450*

- Acciaio AISI 304 satinato
- Dimensioni: **780 x 470** - 1 vasca: **740 x 430**
- Piletta 3½"
- * Il foro necessita di intaglio per l'alloggio del troppo pieno (vedi sito web)

- Disponibile anche in versione **PVD**

Gun Metal
1257 056



pag. 26



Configurazione
 griglie Black
 a filo vasca

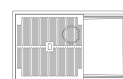

Configurazione
 griglie Black
 su fondo vasca

Base 60



In dotazione: **1 griglia** (8100 615)
 Accessori, disegno tecnico
 e pilette automatiche a pag. 118

1255 050	FT	incasso FT: vedi sito web*
	SPT	incasso SPT: 550 x 450*

- Acciaio AISI 304 satinato
- Dimensioni: **570 x 470** - 1 vasca: **530 x 430**
- Piletta 3½"
- * Il foro necessita di intaglio per l'alloggio del troppo pieno (vedi sito web)

- Disponibile anche in versione **PVD**

Gun Metal
1255 056



pag. 26



Configurazione
 griglie Black
 a filo vasca



Configurazione
 griglie Black
 su fondo vasca

Base 60



In dotazione: **1 griglia** (8100 615)
 Accessori, disegno tecnico
 e pilette automatiche a pag. 118

1254 050	FT	incasso FT: vedi sito web*
	SPT	incasso SPT: 450 x 450*

- Acciaio AISI 304 satinato
- Dimensioni: **470 x 470** - 1 vasca: **430 x 430**
- Piletta 3½"
- * Il foro necessita di intaglio per l'alloggio del troppo pieno (vedi sito web)

- Disponibile anche in versione **PVD**

Gun Metal
1254 056



pag. 27



Configurazione
 griglie Black
 a filo vasca

Quadra EVO | Schema di configurazione griglie

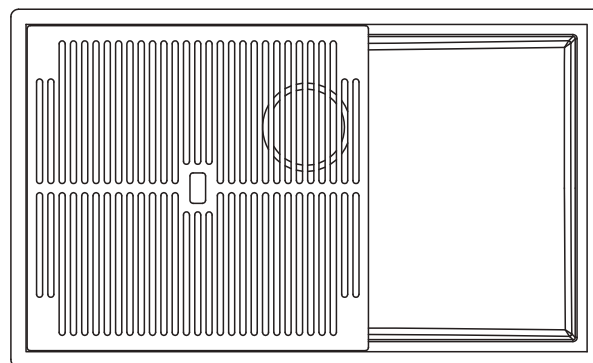
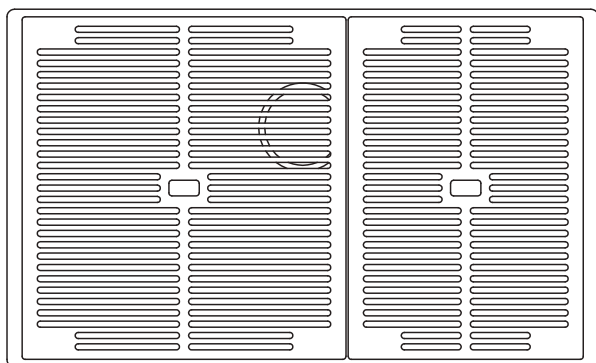

Configurazione **griglie Black 8100 615 + 8100 614**
a filo vasca

Configurazione **griglia Black 8100 615**
in appoggio al gradino perimetrale sul fondo

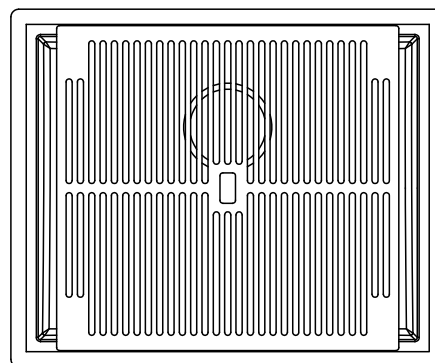
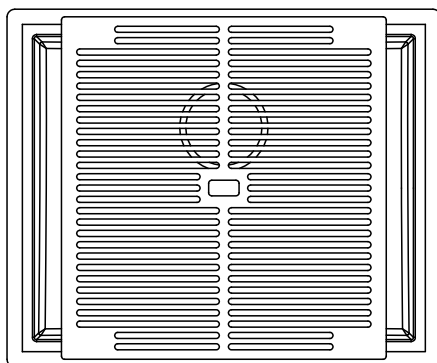

Configurazione **griglia Black 8100 615**
a filo vasca

Configurazione **griglia Black 8100 615**
in appoggio al gradino perimetrale sul fondo

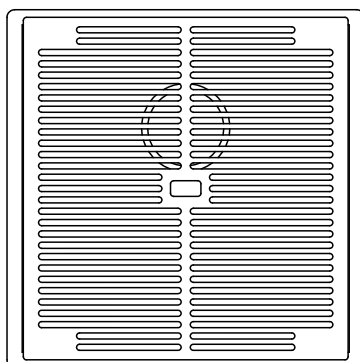

Configurazione **griglia Black 8100 615**
a filo vasca

Quadra EVO

NEW



B1

Griglia Black
42,7 x 45 cm
8100 615

LIV. 1 - 2
in dotazione



B2

Griglia Black
31 x 45 cm
8100 614

LIV. 1
in dotazione



K2

Kit
44,8 x 28,9 cm
8100 037

LIV. 1



T2 *

Cestello portapiatti
inox 21,4x37,9 cm
8100 303



Z2 *

Vaschetta forata inox
21,5x38 cm
8151 000

Disponibile anche in versione PVD



Gun Metal
8151 006



Copper
8151 008



Gold
8151 009



K8 *

Kit grattugie
con anello-supporto
e vaschetta raccogli
vivande
8159 101



X1 *

Vaschetta inox forata
12,6 x 12,1 cm
8151 001



O2

Vaschetta bianca
41,4x27,2 cm
8153 100

Sul fondo

accessori

1257 050 **B1 B2 K2 T2 K8 X1**
O2 Z2

1255 050 **B1 K2 T2 Z2 K8 X1**
O2

1254 050 **B1 K2 T2 Z2 K8 X1**
O2

pilette automatiche opzionali

1257 050 **PL PP PM PA**

1255 050 **PL PP PM PA**

1254 050 **PL PP PM PA**

Vedi pag. 298

* utilizzabile solo in abbinamento al kit K2

1257 050

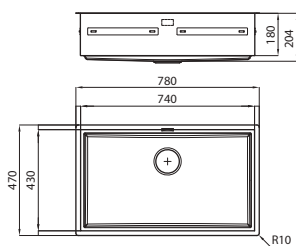

1255 050

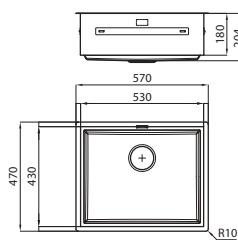

1254 050

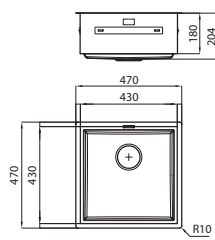

Schema di posizionamento degli accessori sugli invasi

Griglie, taglieri, portautensili, vaschette e contenitori di varie dimensioni si alternano nella zona di lavoro con un semplice gesto e possono essere impilati, sempre a portata di mano.



Quadra R12 NEW
sopratop | filotop





Lavelli con vasche R12



Il fondo è diamantato



In dotazione ci sarà una **griglia Black** che può essere posta sia in appoggio sul piano, sia in appoggio sul fondo (è dotata di 4 gommini)



Quadra R12 Lavelli NEW

sopratop | filotop

Codice

Versione

Caratteristiche

Prezzo

Base 80



In dotazione: **1 griglia** (8100 617)
Accessori, disegno tecnico a pag. 124

1737 050

 **FT**

incasso FT: vedi sito web

 **SPT**

incasso SPT: 770 x 510

- Acciaio AISI 304 satinato
- Dimensioni: **780 x 520** - 1 vasca: **740 x 400**
- Piletta Automatica 3½" PM
- Possibilità di fori aggiuntivi

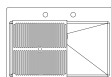

Configurazione
griglie Black in
appoggio sul bordo



Configurazione
griglie Black
su fondo vasca

Base 60



In dotazione: **1 griglia** (8100 617)
Accessori, disegno tecnico a pag. 124

1735 050

 **FT**

incasso FT: vedi sito web

 **SPT**

incasso SPT: 530 x 510

- Acciaio AISI 304 satinato
- Dimensioni: **540 x 520** - 1 vasca: **500 x 400**
- Piletta Automatica 3½" PM
- Possibilità di fori aggiuntivi



Configurazione
griglie Black in
appoggio sul bordo



Configurazione
griglie Black
su fondo vasca

Quadra R12 Vasche NEW

sopratop | filotop

Codice	Versione	Caratteristiche	Prezzo
--------	----------	-----------------	--------

Base 90



1718 050	FT	incasso FT: vedi sito web*
	SPT	incasso SPT: 820 x 430*

- Acciaio AISI 304 satinato
- Dimensioni: **840 x 440** - 1 vasca: **800 x 400**
- Piletta 3½"
- *Il foro necessita di intaglio per l'alloggio del troppo-pieno (solo per top >30)

In dotazione: **1 griglia** (8100 617)
Accessori, disegno tecnico
e pilette automatiche a pag. 124

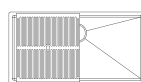

Configurazione
griglie Black in
appoggio sul bordo

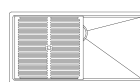

Configurazione
griglie Black
su fondo vasca

Base 80



1717 050	FT	incasso FT: vedi sito web*
	SPT	incasso SPT: 730 x 430*

- Acciaio AISI 304 satinato
- Dimensioni: **750 x 440** - 1 vasca: **710 x 400**
- Piletta 3½"
- *Il foro necessita di intaglio per l'alloggio del troppo-pieno (solo per top >30)

- Disponibile anche in versione **PVD**
- | | | | |
|-------------------------------------|-----------------------------------|----------------------------------|---------------------------------------|
| Gun Metal
1717 056 | GM Fumè
1717 016 | Brandy
1717 055 | Brandy Fumè
1717 015 |
| | | | |
| pag. 28 | pag. 28 | pag. 28 | pag. 28 |

In dotazione: **1 griglia** (8100 617)
Accessori, disegno tecnico
e pilette automatiche a pag. 124

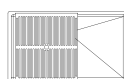

Configurazione
griglie Black in
appoggio sul bordo



Configurazione
griglie Black
su fondo vasca

Base 60



1715 050	FT	incasso FT: vedi sito web*
	SPT	incasso SPT: 520 x 430*

- Acciaio AISI 304 satinato
- Dimensioni: **540 x 440** - 1 vasca: **500 x 400**
- Piletta 3½"
- *Il foro necessita di intaglio per l'alloggio del troppo-pieno (solo per top >30)

- Disponibile anche in versione **PVD**
- | | | | |
|-------------------------------------|-----------------------------------|----------------------------------|---------------------------------------|
| Gun Metal
1715 056 | GM Fumè
1715 016 | Brandy
1715 055 | Brandy Fumè
1715 015 |
| | | | |
| pag. 28 | pag. 28 | pag. 83 | pag. 83 |

In dotazione: **1 griglia** (8100 617)
Accessori, disegno tecnico
e pilette automatiche a pag. 124



Configurazione
griglie Black in
appoggio sul bordo



Configurazione
griglie Black
su fondo vasca



L4

Tagliere in cristallo
23x41 cm
8631 300



N2

Tagliere in HDPE
27,2x42,5 cm
8657 001



N3

Tagliere Twin in HDPE
31,7x41,8 cm
8644 101



K7

Kit tagliere in legno
Iroko 42 x 31,7 cm
con vaschetta
scolapasta
in acciaio inox
8644 044



K8 *

Kit grattugie
con anello-supporto
e vaschetta raccogli
vivande
8159 101



R2

Cestello inox
34x40 cm
8611 000



O2

Vaschetta bianca
41,4x27,2 cm
8153 100



T1

Cestello
portapiatti inox
25x42,5 cm
8100 201



T2 *

Cestello
portapiatti inox
21,4x37,9 cm
8100 303



Z2 *

Vaschetta forata
inox
21,5x38 cm
8151 000

Disponibile anche in versione PVD



Gun Metal
8151 006



Copper
8151 008



Gold
8151 009



B3

Griglia Black
39 x 42 cm
8100 617

in dotazione

1737 050 **L4 N2 N3 K7 K8 R2 O2 T1**
T2 Z2 B3

1735 050 **L4 N2 N3 K7 K8 R2 O2 T1**
T2 Z2 B3

1718 050 **L4 N2 N3 K7 K8 R2 O2 T1**
T2 Z2 B3

1717 050 **L4 N2 N3 K7 K8 R2 O2 T1**
T2 Z2 B3

1715 050 **L4 N2 N3 K7 K8 R2 O2 T1**
T2 Z2 B3

pilette automatiche opzionali

1737 050 **PL PP PA PE PM**

1735 050 **PL PP PA PE PM**

1718 050 **PL PP PA PE PM**

1717 050 **PL PP PA PE PM**

1715 050 **PL PP PA PE PM**

Vedi pag. 298

* utilizzabile solo in abbinamento al tagliere N3

Quadra R12 Lavelli **NEW** | disegni tecnici

1737 050

1735 050

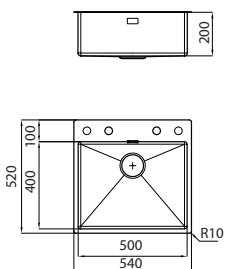
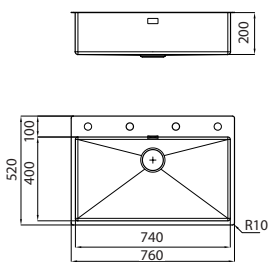

Quadra R12 Vasche **NEW** | disegni tecnici

1718 050

1717 050

1715 050

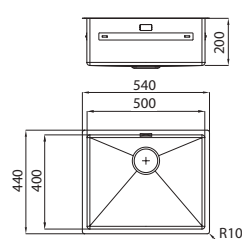
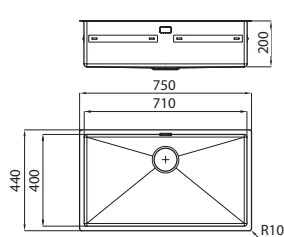
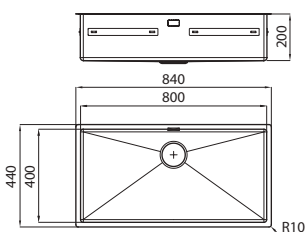

Quadra

sopratop | filotop | semifilotop

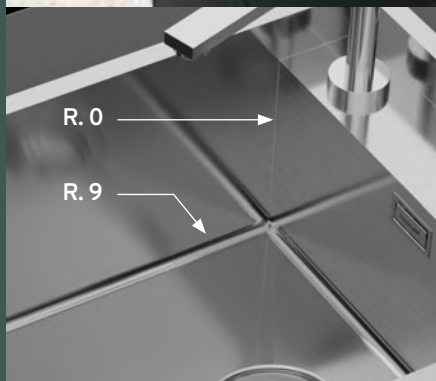

Il raggio R9
sul fondo facilita le
operazioni di pulizia

Quadra

sopratop | filotop

Codice

Versione

Caratteristiche

Prezzo

Base 80



1237 050

FT

incasso FT: vedi sito web

SPT

incasso SPT: 730 x 420

- Acciaio AISI 304 satinato
- Dimensioni: **750 x 440** - 1 vasca: **630 x 400**
- Piletta automatica 3/2" PM
- Possibilità fori aggiuntivi

Accessori e disegno tecnico
a pag. 130

LAVELLI

Base 60



1235 050

FT

incasso FT: vedi sito web

SPT

incasso SPT: 520 x 420

- Acciaio AISI 304 satinato
- Dimensioni: **540 x 440** - 1 vasca: **420 x 400**
- Piletta automatica 3/2" PM
- Possibilità fori aggiuntivi

Accessori e disegno tecnico
a pag. 130

Il lavello può essere installato con banco rubinetteria frontale o laterale

Base 60



1236 050

FT

incasso FT: vedi sito web

SPT

incasso SPT: 420 x 420

- Acciaio AISI 304 satinato
- Dimensioni: **440 x 440** - 1 vasca: **320 x 400**
- Piletta automatica 3/2" PM
- Possibilità fori aggiuntivi

Accessori e disegno tecnico
a pag. 130

Il lavello può essere installato con banco rubinetteria frontale o laterale

Quadra

sopratop | filotop | semifilotop

Base (80)⁹/120 (rif. pag. 16)



Accessori, disegno tecnico e pilette automatiche a pag. 130

Codice

Versione

Caratteristiche

Prezzo

1220 050

FT

incasso FT: vedi sito web

SPT

incasso SPT: 987 x 427

- Acciaio AISI 304 satinato
- Dimensioni: **1000 x 440** - 1 vasca: **675 x 400**
- Piletta 3½"

Base 90



Accessori, disegno tecnico e pilette automatiche a pag. 130

1218 050

FT

incasso FT: vedi sito web

SPT

incasso SPT: 847 x 447

- Acciaio AISI 304 satinato
- Dimensioni: **864 x 464** - 1 vasca: **800 x 400**
- Piletta 3½"

Base 90



Accessori e disegno tecnico a pag. 130

1219 050

SF

incasso SF: 820 x 495

1229 050

FT

incasso FT: vedi sito web

SPT

incasso SPT: 808 x 486

- Acciaio AISI 304 satinato
- **SF** Dimensioni: **840 x 510** - 1 vasca: **761 x 400**
- **FT** e **SPT** Dimensioni: **825 x 503** - 1 vasca: **761 x 400**
- Piletta automatica 3½" PM
- Possibilità fori aggiuntivi

Quadra

sopratop | filotop | semifilotop

Base 90 **NEW**



Accessori, disegno tecnico e pilette automatiche a pag. 130

Codice

Versione

Caratteristiche

Prezzo

1221 050

FT

incasso FT: vedi sito web*

SPT

incasso SPT: 820 x 420*

- Acciaio AISI 304 satinato
- Dimensioni: **840 x 440** - 2 vasche: **380 x 400**
- Piletta 3½"

* Il foro di incasso necessita di intaglio per l'alloggio del troppo-pieno (vedi sito web)

Base 60



Accessori, disegno tecnico e pilette automatiche a pag. 130

1215 050

FT

incasso FT: vedi sito web

SPT

incasso SPT: 547 x 447

- Acciaio AISI 304 satinato
- Dimensioni: **564 x 464** - 1 vasca: **500 x 400**
- Piletta 3½"

Base 45



Accessori e disegno tecnico a pag. 130

1205 050

SF

incasso SF: 459 x 495

- Acciaio AISI 304 satinato
- Dimensioni: **479 x 510** - 1 vasca: **400 x 400**
- Piletta Automatica 3½" PM



B3

Griglia Black
39 x 42 cm
8100 617

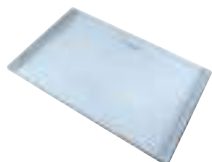

L4

Tagliere cristallo
23x41 cm
8631 300



N2

Tagliere in HDPE
27,2x42,5 cm
8657 001



N3

Tagliere Twin
in HDPE 31,7x41,8
8644 101



O2

Vaschetta bianca
27,2x41,4 cm
8153 100



K7

Kit tagliere in legno
Iroko 42 x 31,7 cm
con vaschetta
scolapasta
in acciaio inox
8644 044



K8 *

Kit grattugie con
anello-supporto e
vaschetta vivande
8159 101



R2

Cestello Inox
34x40 cm
8611 000



R3

Cestello Inox
40x40
8612 000



T1

Cestello portapiatti
inox 25x42,5 cm
8100 201

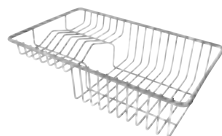

T2 *

Cestello portapiatti
inox 21,4x37,9 cm
8100 303



Z2 *

Vaschetta forata
inox 21,5x38 cm
8151 000

Disponibile anche in versione PVD



Gun Metal
8151 006



Copper
8151 008



Gold
8151 009

1237 050 **B3 L4 N2 N3 O2 K7 K8 R2**
R3 T T2 Z2

1235 050 **B3 L4 N2 N3 O2 K7 K8 R2**
R3 T T2 Z2

1236 050 **B3 L4 N2 N3 O2 K7 K8 R2**
R3 T T2 Z2

1220 050 **B3 L4 N2 N3 O2 K7 K8 R2**
R3 T T2 Z2

1218 050 **B3 L4 N2 N3 O2 K7 K8 R2**
R3 T T2 Z2

1219 050 **B3 L4 N2 N3 O2 K7 K8 R2**
1229 050 **R3 T T2 Z2**

1221 050 **B3 L4 N2 N3 O2 K7 K8 R2**
R3 T T2 Z2

1215 050 **B3 L4 N2 N3 O2 K7 K8 R2**
T2 T T2 Z2

pilette automatiche opzionali

1221 050 **PL PA PM PP**

1220 050 **PL PB PA PM**

1218 050 **PL PB PA PM**

1215 050 **PL PB PA PM**

Vedi pag. 298

* utilizzabile solo in abbinamento al tagliere N3

1237 050

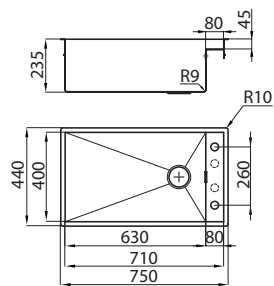

1235 050

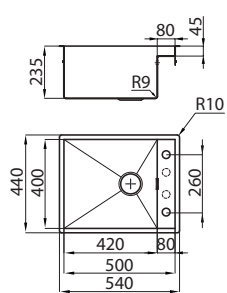

1236 050

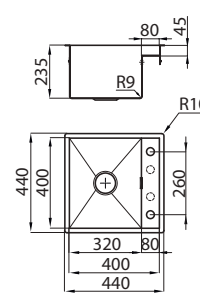

1220 050

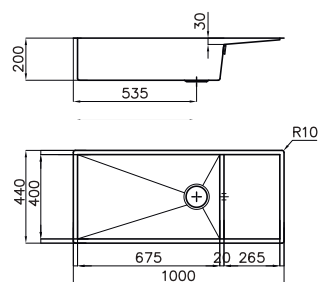

1218 050

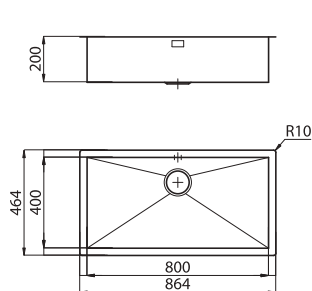

1219 050

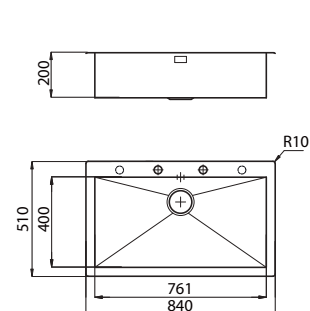

1221 050

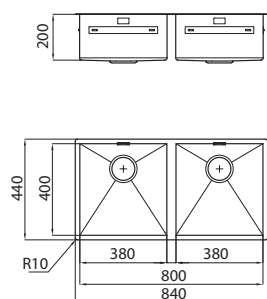

1215 050

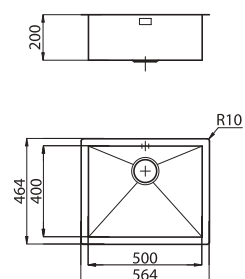

1205 050

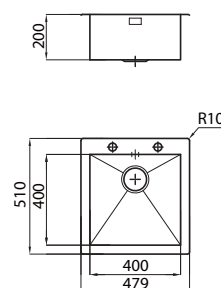

1229 050

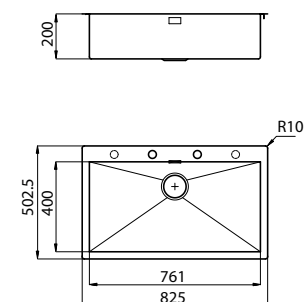

Circolari NEW

sopratop | filotop

Lavello
di spessore

Lucidatura
concentrica
di grande effetto



Base 45



Codice	Versione	Caratteristiche	Prezzo
--------	----------	-----------------	--------

1130 060

Versione

FT

Caratteristiche

incasso FT: vedi sito web*

SPT

incasso SPT: Ø 410*

- Acciaio AISI 304 satinato
- Dimensioni: Ø 425 - 1 vasca: Ø 380
- Piletta 3½"
- *Il foro di incasso necessita di intaglio per l'alloggio del troppo pieno

• Disponibile anche in versione **PVD**

Gun Metal
1130 066



pag. 29

Copper
1130 068



pag. 52

Gold
1130 069



pag. 70

accessori



P1

Tagliere
41,4 x 32 cm
in legno Iroko
8648 002

pilette automatiche opzionali

PR PQ PC

Vedi pag. 298

disegno tecnico

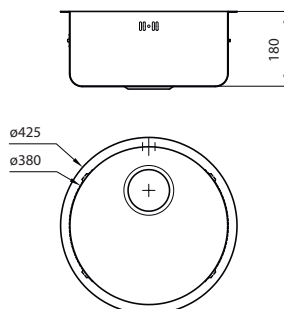



S4001 lavelli

sopratop | filotop



Base 90

NEW



Accessori e disegno tecnico a pag. 140

Codice	Versione	Caratteristiche	Prezzo
3367 050	FT	incasso FT: vedi sito web	
	SPT	incasso SPT: 848 x 508	

- Acciaio AISI 304 satinato
- Dimensioni: **860 x 520** - 1 vasca: **800 x 400**
- Piletta automatica Space 3½" PA
- Possibilità fori aggiuntivi

S4001 lavelli sopratop | filotop

Codice

Versione

Caratteristiche

Prezzo

Base 80



3366 050

FT

incasso FT: vedi sito web

SPT

incasso SPT: 758 x 508

- Acciaio AISI 304 satinato
- Dimensioni: **770 x 520** - 1 vasca: **710 x 400**
- Piletta automatica Space 3½" PA
- Possibilità fori aggiuntivi

Accessori e disegno tecnico a pag. 140

Base 60



3365 050

FT

incasso FT: vedi sito web

SPT

incasso SPT: 548 x 508

- Acciaio AISI 304 satinato
- Dimensioni: **560 x 520** - 1 vasca: **500 x 400**
- Piletta automatica Space 3½" PA
- Possibilità fori aggiuntivi

Accessori e disegno tecnico a pag. 140

Base 45



3363 050

FT

incasso FT: vedi sito web

SPT

incasso SPT: 448 x 508

- Acciaio AISI 304 satinato
- Dimensioni: **460 x 520** - 1 vasca: **400 x 400**
- Piletta automatica Space 3½" PA
- Possibilità fori aggiuntivi

Accessori e disegno tecnico a pag. 140

S4001 vasche R12
sopratop | filotop





Lavelli con vasche R12

S4001 vasche R12

sopratop | filotop

Codice

Versione

Caratteristiche

Prezzo

Base 90



3358 050

FT

incasso FT: vedi sito web*

SPT

incasso SPT: 820 x 430*

- Acciaio AISI 304 satinato
- Dimensioni: **840 x 440** - 1 vasca: **800 x 400**
- Piletta Space 3½"

* Il foro incasso necessita di intaglio per l'alloggio del troppo-pieno (solo per top > 30)

Accessori, disegno tecnico
e pilette automatiche a pag. 140

Base 80



3357 050

FT

incasso FT: vedi sito web*

SPT

incasso SPT: 730 x 430*

- Acciaio AISI 304 satinato
- Dimensioni: **750 x 440** - 1 vasca: **710 x 400**
- Piletta Space 3½"

* Il foro incasso necessita di intaglio per l'alloggio del troppo-pieno (solo per top > 30)

Accessori, disegno tecnico
e pilette automatiche a pag. 140

Base 80



3352 050

FT

incasso FT: vedi sito web*

SPT

incasso SPT: 730 x 430*

- Acciaio AISI 304 satinato
- Dimensioni: **750 x 440** - 2 vasche: **340 x 400**
- Piletta Space 3½"

* Il foro incasso necessita di intaglio per l'alloggio del troppo-pieno (solo per top > 30)

Accessori, disegno tecnico
e pilette automatiche a pag. 140

S4001 vasche R12

sopratop | filotop

Codice	Versione	Caratteristiche	Prezzo
--------	----------	-----------------	--------

Base 60



3355 050	 FT	incasso FT: vedi sito web*
	 SPT	incasso SPT: 520 x 430*

- Acciaio AISI 304 satinato
- Dimensioni: **540 x 440** - 1 vasca: **500 x 400**
- Piletta Space 3½"

* Il foro incasso necessita di intaglio per l'alloggio del troppo-pieno (solo per top > 30)

Accessori, disegno tecnico e pilette automatiche a pag. 140

Base 45



3356 050	 FT	incasso FT: vedi sito web*
	 SPT	incasso SPT: 420 x 430*

- Acciaio AISI 304 satinato
- Dimensioni: **440 x 440** - 1 vasca: **400 x 400**
- Piletta Space 3½"

* Il foro incasso necessita di intaglio per l'alloggio del troppo-pieno (solo per top > 30)

Accessori, disegno tecnico e pilette automatiche a pag. 140

Base 40



3353 050	 FT	incasso FT: vedi sito web*
	 SPT	incasso SPT: 360 x 430*

- Acciaio AISI 304 satinato
- Dimensioni: **380 x 440** - 1 vasca: **340 x 400**
- Piletta Space 3½"

* Il foro incasso necessita di intaglio per l'alloggio del troppo-pieno (solo per top > 30)

Accessori, disegno tecnico e pilette automatiche a pag. 140

B3



Griglia Black
39 x 42 cm
8100 617

B6



Griglia Black
38 x 38 cm
8100 651

B7



Griglia Black
38 x 48 cm
8100 652

B8



Griglia Black
38 x 69 cm
8100 653

K7



Kit tagliere in legno
Iroko 42 x 31,7 cm
con vaschetta
scolapasta
in acciaio inox
8644 044

L4



Tagliere cristallo
23x41 cm
8631 300

N2



Tagliere in HDPE
27,2x42,5 cm
8657 001

N3



Tagliere Twin
in HDPE 31,7x41,8
8644 101

O2



Vaschetta bianca
27,2x41,4 cm
8153 100



K8 *

Kit grattugie con
anello-supporto e
vaschetta vivande
8159 101

R2



Cestello Inox
34x40 cm
8611 000

R3



Cestello Inox
40x40
8612 000

T2 *

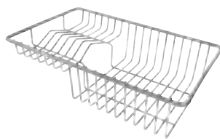

Cestello portapiatti
inox 21,4x37,9 cm
8100 303

Z2 *



Vaschetta forata
inox 21,5x38 cm
8151 000

Disponibile anche in versione PVD



Gun Metal
8151 006



Copper
8151 008



Gold
8151 009

3367 050 **B3 K7 L4 N2 N3 O2 K8 R2**
R3 T1 T2 Z2 B8

3366 050 **B3 K7 L4 N2 N3 O2 K8 R2**
R3 T1 T2 Z2

3365 050 **B3 K7 L4 N2 N3 O2 K8 R2**
R3 T1 T2 Z2

3363 050 **K7 L4 N2 N3 O2 K8 R2 R3**
T1 T2 Z2

3358 050 **B3 K7 L4 N2 N3 O2 K8 R2**
R3 T1 T2 Z2 B8

3357 050 **B3 B8 K7 L4 N2 N3 O2 K8**
R2 R3 T1 T2 Z2

3352 050 **K7 L4 N2 N3 O2 K8 R2 R3**
T1 T2 Z2

3355 050 **B3 B7 K7 L4 N2 N3 O2 K8**
R2 R3 T1 T2 Z2

3356 050 **B3 B6 K7 L4 N2 N3 O2 K8**
R2 R3 T1 T2 Z2

3353 050 **K7 L4 N2 N3 O2 K8 R2 R3**
T1 T2 Z2

pilette automatiche opzionali

3358 050 **PA PE PM PL PP**

3357 050 **PA PE PM PL PP**

3352 050 **PA PE PM PL PP**

3355 050 **PA PE PM PL PP**

3356 050 **PA PE PM PL PP**

3353 050 **PA PE PM PL PP**

Vedi pag. 298

* utilizzabile solo in abbinamento al tagliere N3

S4001 | lavelli

disegni tecnici

3367 050

NEW

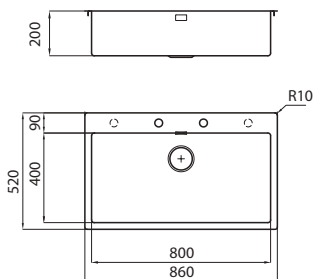

3366 050

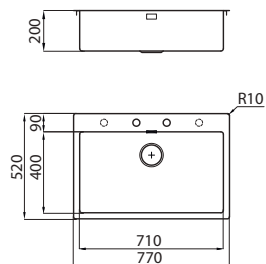

3365 050

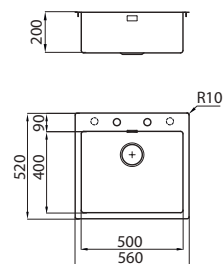

3363 050

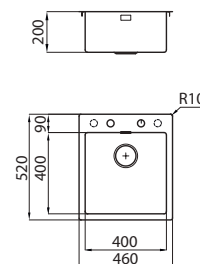

S4001 | vasche R12

disegni tecnici

3358 050

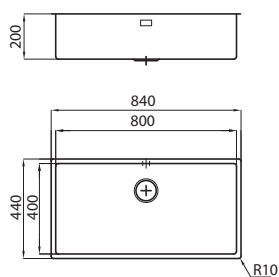

3357 050

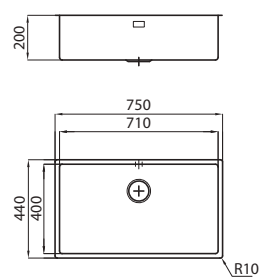

3352 050

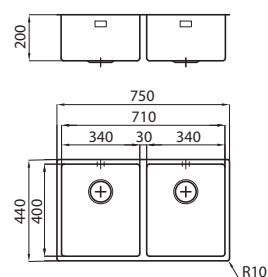

3355 050

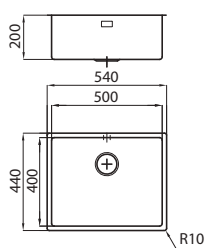

3356 050

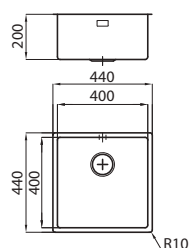

3353 050

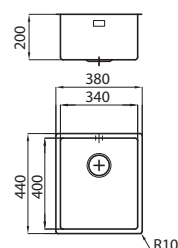

New Wave

sopratop | filotop



red dot design award
winner 2015



Caratteristico design

del gocciolatoio con raffinato
ampio raggio di raccordo.

New Wave

sopratop | filotop

Codice



Versione

Caratteristiche

Prezzo

Base 80



1416 001 dx	 FT	incasso FT: vedi sito web
1416 002 sx	 SPT	incasso SPT: 1148 x 508



- Acciaio AISI 304 satinato
- Dimensioni: **1160 x 520** - 1 vasca: **710 x 400**
- Piletta automatica Space 3,5" PA

Accessori e disegno tecnico a pag. 144

In foto versione sinistra

Base 80





1412 000	 FT	incasso FT: vedi sito web
	 SPT	incasso SPT: 798 x 508

- Acciaio AISI 304 satinato
- Dimensioni: **810 x 520** - 1 vasca: **710 x 400**
- Piletta automatica Space 3,5" PA

Accessori e disegno tecnico a pag. 144

Base 60



1410 000	 FT	incasso FT: vedi sito web
	 SPT	incasso SPT: 588 x 508

- Acciaio AISI 304 satinato
- Dimensioni: **600 x 520** - 1 vasca: **500 x 400**
- Piletta automatica Space 3,5" PA

Accessori e disegno tecnico a pag. 144

New Wave | accessori



L4

Tagliere cristallo
23 x 41 cm
8631 300



N2

Tagliere in HDPE
27,2 x 42,5 cm
8657 001



N3

Tagliere Twin
in HDPE
31,7 x 41,8 cm
8644 101



O2

Vaschetta bianca
27,2 x 41,4 cm
8153 100



K8 *

Kit grattugie
con anello supporto
e vaschetta raccogli
vivande
8159 101



R3

Cestello Inox
40 x 40 cm
8612 000



T1

Cestello portapiatti
25 x 42,5 cm
8100 201



T2 *

Cestello portapiatti
Inox 21,4 x 37,9 cm
8100 303



Z2 *

Vaschetta forata
Inox 21,5 x 38 cm
8151 000



B3

Griglia Black
39 x 42 cm
8100 617

1416 001 L4 N2 N3 O2 K8 R3 T1 T2
1416 002 Z2 B3

1412 000 L4 N2 N3 O2 K8 R3 T1 T2

Z2 B3

1410 000 L4 N2 N3 O2 K8 R3 T1 T2

Z2 B3

Disponibile anche in versione **PVD**



Gun Metal
8151 006



Copper
8151 008



Gold
8151 009

* utilizzabile solo in abbinamento al tagliere N3

1416 001 dx | 1416 002 sx

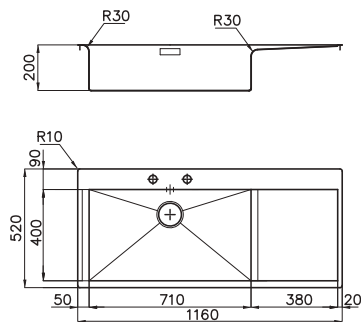

1412 000

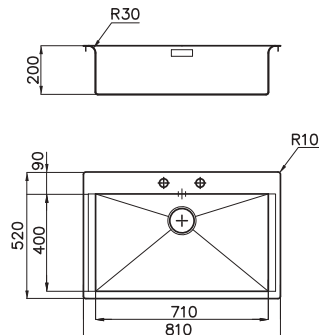

1410 000

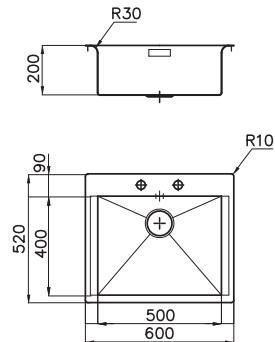

Fortyfour
standard



Abbinamento
perfetto

perfettamente
coordinato

con il piano cottura
Veronika 3 fuochi
e con il piano
induzione
S1000 3 zone.



Codice

Versione

Caratteristiche

Prezzo

Base 45

4151 050



incasso: 420 x 480



- Acciaio AISI 304 satinato
- Dimensioni: **440 x 500** - 1 vasca: **365 x 350**
- Piletta 3/2"
- Possibilità fori aggiuntivi

accessori



P3

Tagliere
26 x 36,6 cm
8643 117



T6

Griglia portapiatti
inox 23 x 37,5
8100 305

pilette automatiche opzionali

PA PE PM PL PP

Vedi pag. 298

disegno tecnico

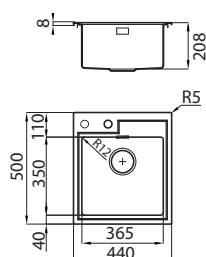

abbinamento perfetto

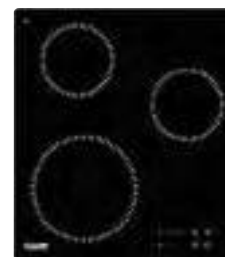

Fortyfour è un lavello pensato per i piccoli spazi che richiedono estetica e funzionalità. Tutta la libertà di abbinamento: Fortyfour è perfettamente coordinato con il piano cottura Veronika 3 fuochi e con il piano induzione S1000 3 zone.

Master
sopratop | filotop



Master

sopratop | filotop

Codice

Versione

Caratteristiche

Prezzo

Base 80



1252 051 dx	 FT	incasso FT: vedi sito web
1252 052 sx	 SPT	incasso SPT: 1147 x 507

- Acciaio AISI 304 satinato
- Dimensioni: **1160 x 520** - 2 vasche: **340 x 400**
- Piletta automatica 3½" PM
- Possibilità fori aggiuntivi

Accessori e disegno tecnico a pag. 150

In foto versione sinistra

Base 60



1251 051 dx	 FT	incasso FT: vedi sito web
1251 052 sx	 SPT	incasso SPT: 987 x 507



- Acciaio AISI 304 satinato
- Dimensioni: **1000 x 520** - 2 vasche: **340 x 400 + 180 x 400**
- Piletta automatica 3½" PM
- Possibilità fori aggiuntivi

Accessori e disegno tecnico a pag. 150

In foto versione sinistra

Base 60



1250 051 dx	 FT	incasso FT: vedi sito web
1250 052 sx	 SPT	incasso SPT: 847 x 507

- Acciaio AISI 304 satinato
- Dimensioni: **860 x 520** - 1 vasca: **450 x 400**
- Piletta automatica 3½" PM
- Possibilità fori aggiuntivi

Accessori e disegno tecnico a pag. 150

In foto versione sinistra

Master

accessori

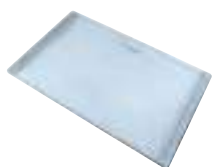

L4

Tagliere cristallo
23x41 cm
8631 300



N2

Tagliere in HDPE
27,2x42,5 cm
8657 001



N3

Tagliere Twin
in HDPE 31,7x41,8
8644 101



O2

Vaschetta bianca
27,2x41,4 cm
8153 100



K7

Kit tagliere in legno
Iroko 42 x 31,7 cm
con vaschetta
scolapasta
in acciaio inox
8644 044



K8 *

Kit grattugie con
anello-supporto e
vaschetta vivande
8159 101



R2

Cestello Inox
34x40 cm
8611 000



R3

Cestello Inox
40x40 - 8612 000



T1

Cestello portapiatti
inox 25x42,5 cm
8100 201

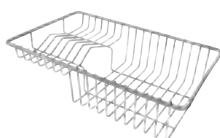

T2 *

Cestello portapiatti
inox 21,4x37,9 cm
8100 303



Z2 *

Vaschetta forata
inox 21,5x38 cm
8151 000

Disponibile anche in versione PVD



Gun Metal
8151 006



Copper
8151 008



Gold
8151 009

1252 051 L4 N2 N3 O2 K7 K8 R2 R3
1252 052 T1 T2 T2

1251 051 L4 N2 N3 O2 K7 K8 R2 R3
1251 052 T1 T2 T2

1250 051 L4 N2 N3 O2 K7 K8 R2 R3
1250 052 T1 T2 T2

* utilizzabile solo in abbinamento al tagliere N3

1252 051 dx | 1252 052 sx

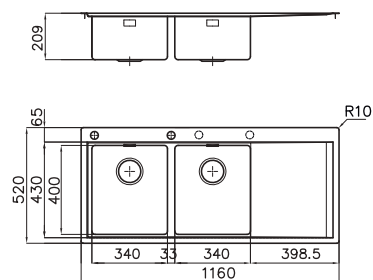

1251 051 dx | 1251 052 sx

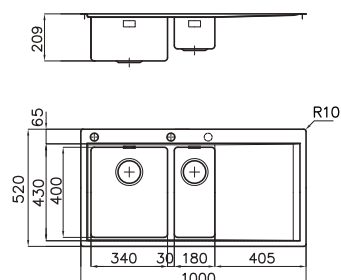

1250 051 dx | 1250 052 sx

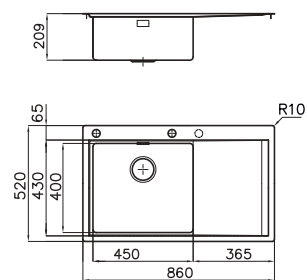

FL

sopratop | filotop | standard



Abbinamento
perfetto



perfettamente
coordinato

con il piano cottura
FL 5 fuochi



Base 80



Codice	Versione	Caratteristiche	Prezzo
2975 060	 STD	incasso STD: 840 x 480	
2977 060	 FT	incasso FT: vedi sito web	
	 SPT	incasso SPT: 860 x 500	

- Acciaio AISI 304 satinato
- Dimensioni: **STD 860 x 500** - 1 vasca: **720 x 320**
- Dimensioni: **FT/SPT 873 x 513** - 1 vasca: **720 x 320**
- Piletta Space 3½"
- Possibilità fori aggiuntivi

disegni tecnici

2977 060

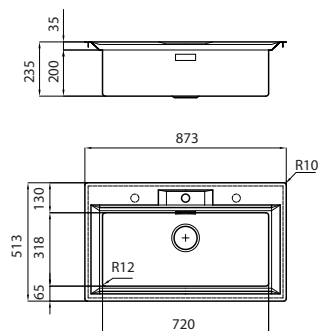

2975 060

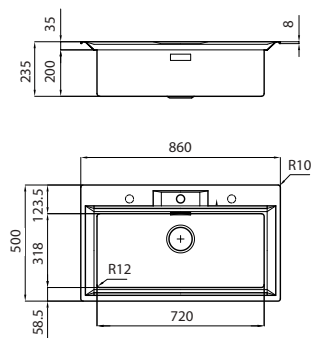

accessori



T5

Cestello portapiatti
inox 21,4 x 33,1
8100 304

KE
semifilotop



KE

semifilotop

Codice

Versione

Caratteristiche

Prezzo

Base 90

2211 051 dx
2211 052 sx



incasso: 1140 x 480



- Acciaio AISI 304 satinato
- Dimensioni: **1173 x 513** - 1 vasca: **710 x 400**
- Piletta 3½"
- Possibilità fori aggiuntivi

Accessori, disegno tecnico
e pilette automatiche a pag. 162

In foto versione sinistra

Base 80

2263 051 dx
2263 052 sx



incasso: 950 x 480



- Acciaio AISI 304 satinato
- Dimensioni: **983 x 513** - 1 vasca: **500 x 400**
- Piletta 3½"
- Possibilità fori aggiuntivi

Accessori, disegno tecnico
e pilette automatiche a pag. 162

In foto versione sinistra

Base 60/(80)^T (rif. pag. 16)

2297 051 dx
2297 052 sx



incasso: 950 x 480



- Acciaio AISI 304 satinato
- Dimensioni: **983 x 513** - 2 vasche: **180 x 340 + 340 x 400**
- Piletta 3½"
- Possibilità fori aggiuntivi

Accessori, disegno tecnico
e pilette automatiche a pag. 162

In foto versione sinistra

KE

semifilotop

Codice

Versione

Caratteristiche

Prezzo

Base 90

2287 050



incasso: 840 x 480



- Acciaio AISI 304 satinato
- Dimensioni: **873 x 513** - 1 vasca: **710 x 400**
- Piletta 3½"
- Possibilità fori aggiuntivi

Accessori, disegno tecnico
e pilette automatiche a pag. 162

Base 90

2283 050



incasso: 840 x 480



- Acciaio AISI 304 satinato
- Dimensioni: **873 x 513** - 2 vasche: **340 x 400**
- Piletta 3½"

Accessori e disegno tecnico a pag. 162

Base 60

2280 051 dx
2280 052 sx



incasso: 840 x 480



- Acciaio AISI 304 satinato
- Dimensioni: **873 x 513** - 1 vasca: **450 x 400**
- Piletta 3½"
- Possibilità fori aggiuntivi

Accessori, disegno tecnico
e pilette automatiche a pag. 162

In foto versione sinistra



KE



sopratop | filotop | Q4



Base 80



Accessori e disegno tecnico a pag. 162

Codice	Versione	Caratteristiche	Prezzo
2278 050	 Q4	incasso: 750 x 500	
2266 050	 FT	incasso FT: vedi sito web	
	 SPT	incasso SPT: 758 x 508	

- Acciaio AISI 304 satinato
- Dimensioni: **770 x 520** - 1 vasca: **710 x 400**
- Piletta automatica 3½" PM
- Possibilità fori aggiuntivi

- Disponibile anche in versione **Vintage**
FT - SPT
2266 080



KE

sopratop | filotop | Q4

Base 80



Accessori e disegno tecnico a pag. 162

Codice	Versione	Caratteristiche	Prezzo
--------	----------	-----------------	--------

2279 050	 Q4	incasso: 750 x 500
----------	---	--------------------

2269 050	 FT	incasso FT: vedi sito web
	 SPT	incasso SPT: 758 x 508

- Acciaio AISI 304 satinato
- Dimensioni: **770 x 520** - 2 vasche: **340 x 400**
- Piletta automatica 3½" PM
- Possibilità fori aggiuntivi

- Disponibile anche in versione **Vintage**
FT - SPT
2269 080



Base 60



Accessori e disegno tecnico a pag. 162

2272 050	 Q4	incasso: 540 x 500
----------	---	--------------------

2265 050	 FT	incasso FT: vedi sito web
	 SPT	incasso SPT: 548 x 508

- Acciaio AISI 304 satinato
- Dimensioni: **560 x 520** - 1 vasca: **500 x 400**
- Piletta automatica 3½" PM

- Disponibile anche in versione **Vintage**
FT - SPT
2265 080



Base 60



Accessori e disegno tecnico a pag. 162

2274 050	 Q4	incasso: 490 x 500
----------	---	--------------------

2264 050	 FT	incasso FT: vedi sito web
	 SPT	incasso SPT: 498 x 508

- Acciaio AISI 304 satinato
- Dimensioni: **510 x 520** - 1 vasca: **450 x 400**
- Piletta automatica 3½" PM

- Disponibile anche in versione **Vintage**
FT - SPT
2264 080



KE vasche R15

sopratop | filotop



Base 80







Accessori, disegno tecnico e pilette automatiche a pag. 162

Codice	Versione	Caratteristiche	Prezzo
2157 050	FT	incasso FT: vedi sito web*	
	SPT	incasso SPT: 730 x 420*	

- Acciaio AISI 304 satinato
- Dimensioni: **750 x 440** - 1 vasca: **710 x 400**
- Piletta 3½"

* Il foro incasso necessita di intaglio per l'alloggio del troppo-pieno (vedi sito web)

• Disponibile anche in versione **Vintage, PVD e PVD Vintage**

Vintage inox 2157 080	Gun Metal 2157 056	Copper 2157 058	Gold 2157 059	Brandy 2157 055
				
	pag. 30	pag. 50	pag. 68	pag. 84

KE vasche R15

sopratop | filotop

Base 60

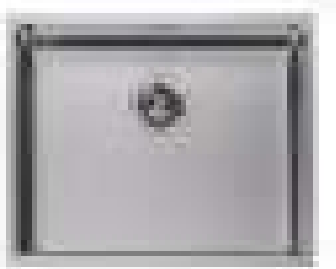





Accessori, disegno tecnico e pilette automatiche a pag. 162

Codice	Versione	Caratteristiche	Prezzo
2155 050	FT	incasso FT: vedi sito web*	
	SPT	incasso SPT: 520 x 420*	

- Acciaio AISI 304 satinato
- Dimensioni: **540 x 440** - 1 vasca: **500 x 400**
- Piletta 3½"

* Il foro incasso necessita di intaglio per l'alloggio del troppo-pieno (vedi sito web)

• Disponibile anche in versione **Vintage, PVD e PVD Vintage**

Vintage inox	Gun Metal	Copper	Gold	Brandy
2155 080	2155 056	2155 058	2155 059	2155 055
				
	Vintage 2155 086			
	pag. 30	pag. 50	pag. 68	pag. 85

Base 60



Accessori, disegno tecnico e pilette automatiche a pag. 162

2154 050	FT	incasso FT: vedi sito web*
	SPT	incasso SPT: 470 x 420*

- Acciaio AISI 304 satinato
- Dimensioni: **490 x 440** - 1 vasca: **450 x 400**
- Piletta 3½"

* Il foro incasso necessita di intaglio per l'alloggio del troppo-pieno (vedi sito web)

• Disponibile anche in versione **PVD**

Gun Metal
2154 056



pag. 31

Base 45



Accessori, disegno tecnico e pilette automatiche a pag. 162

2156 050	FT	incasso FT: vedi sito web*
	SPT	incasso SPT: 420 x 420*

- Acciaio AISI 304 satinato
- Dimensioni: **440 x 440** - 1 vasca: **400 x 400**
- Piletta 3½"

* Il foro incasso necessita di intaglio per l'alloggio del troppo-pieno (vedi sito web)

• Disponibile anche in versione **Vintage, PVD e PVD Vintage**

Vintage inox
2156 080



pag. 32

Gun Metal
2156 056



pag. 32

B3

Griglia Black
39 x 42 cm
8100 617



B6

Griglia Black
38 x 38 cm
8100 651



B7

Griglia Black
38 x 48 cm
8100 652



B8

Griglia Black
38 x 69 cm
8100 653



L4

Tagliere cristallo
23x41 cm
8631 300



N2

Tagliere in HDPE
27,2x42,5 cm
8657 001



N3

Tagliere Twin
in HDPE 31,7x41,8
8644 101



O2

Vaschetta bianca
27,2x41,4 cm
8153 100



K7

Kit tagliere in legno
Iroko 42 x 31,7 cm
con vaschetta
scolapasta
in acciaio inox
8644 044



K8 *

Kit grattugie con
anello-supporto e
vaschetta vivande
8159 101



R2

Cestello Inox
34x40 cm
8611 000



R3

Cestello Inox
40x40
8612 000



T1

Cestello portapiatti
inox 25x42,5 cm
8100 201

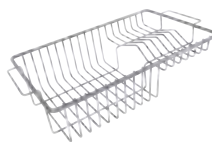

T2 *

Cestello portapiatti
inox 21,4x37,9 cm
8100 303

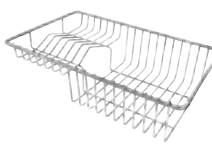

Z2 *

Vaschetta forata
inox 21,5x38 cm
8151 000



Disponibile anche in versione PVD



Gun Metal
8151 006



Copper
8151 008



Gold
8151 009

* utilizzabile solo in abbinamento al tagliere N3

pilette automatiche opzionali

2211 051 **PA PE PM PL PP**
2211 052

2263 051 **PA PE PM PL PP**
2263 052

2297 051 **PA PE PM PL PP**
2297 052

2287 050 **PA PE PM PL PP**

2280 051 **PA PE PM PL PP**
2280 052

2157 050 **PA PE PM PL PP**

2155 050 **PA PE PM PL PP**

2154 050 **PA PE PM PL PP**

2156 050 **PA PE PM PL PP**

2211 051 **B8 L4 N2 N3 B3 O2 K7 K8**
2211 052 **R2 R3 T1 T2 Z2**

2263 051 **L4 N2 N3 O2 K7 K8 R3 T1**
2263 052 **T2 Z2 B3 B7 R2**

2297 051 **L4 N2 N3 O2 K7 K8 R2 T1**
2297 052 **T2 Z2**

2287 050 **B8 L4 N2 N3 O2 K7 K8 R3**
T1 T2 Z2 B3 R2

2283 050 **L4 N2 N3 O2 K7 K8 R2 T1**
T2 Z2

2280 051 **L4 N2 N3 O2 K7 K8 R3 T1**
2280 052 **T2 Z2 B3 R3 R2**

2278 050 **B3 B8 L4 N2 N3 O2 K7 K8**
2266 050 **R3 T1 T2 Z2 R2**

2279 050 **N2 N3 O2 K7 K8 R2 T1 T2**
2269 050 **Z2 L4**

2272 050 **B7 L4 N2 N3 O2 K7 K8 R3**
2265 050 **T1 T2 Z2 B3 R2**

2274 050 **B3 L4 N2 N3 O2 K7 K8 R3**
2264 050 **T1 T2 Z2 B3**

2157 050 **B3 B8 L4 N2 N3 O2 K7 K8**
R3 T1 T2 Z2 R2

2155 050 **B3 B7 L4 N2 N3 O2 K7 K8**
R3 T1 T2 Z2 R2

2154 050 **B3 L4 N2 N3 O2 K7 K8 R3**
T1 T2 Z2 R2

2156 050 **B6 L4 N2 N3 O2 K7 K8 R3**
T1 T2 Z2 R2

Vedi pag. 298

2211 051 dx | 2211 052 sx

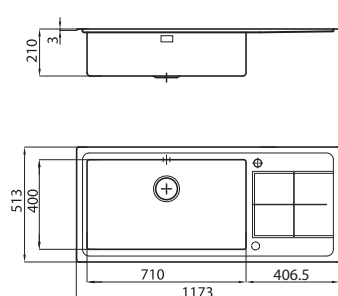

2263 051 dx | 2263 052 sx

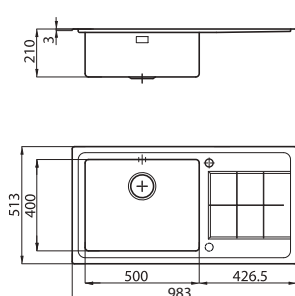

2297 051 dx | 2297 052 sx

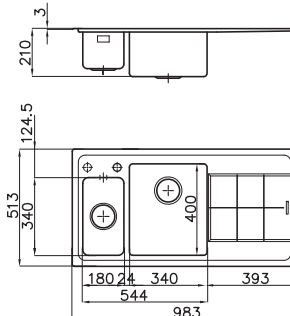

2287 050

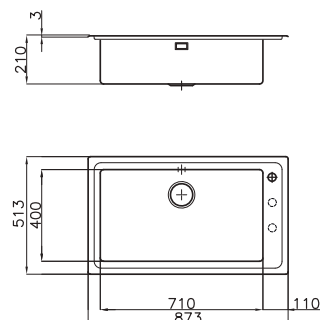

2283 050

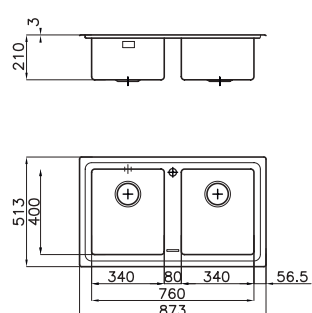

2280 051 dx | 2280 052 sx

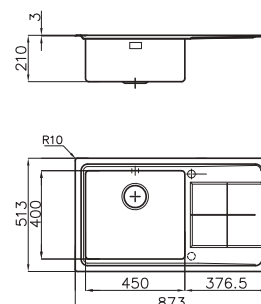

KE Q4 e filotop

2278 050 | 2266 050

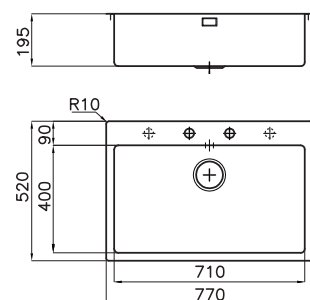

2279 050 | 2269 050

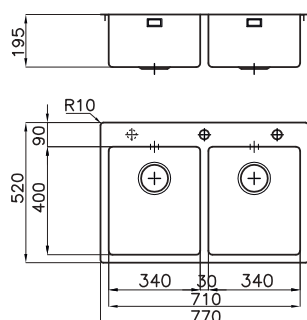

2272 050 | 2265 050

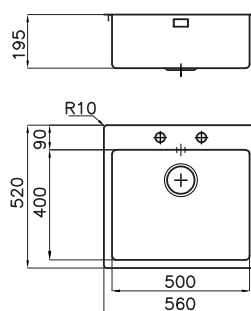

2274 050 | 2264 050

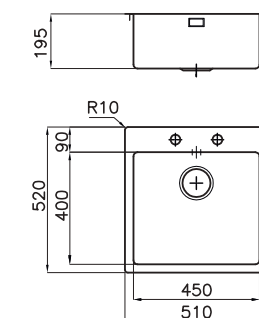

KE vasche filotop

2157 050

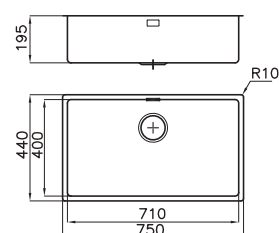

2155 050

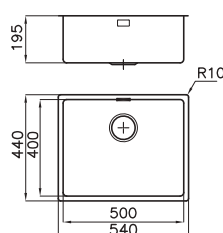

2154 050

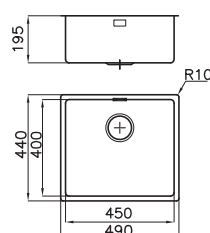

2156 050

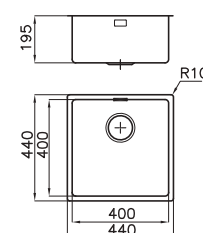

Stripe

semifilotop



L'elegante gocciolatoio

a strisce è al contempo
superficie di appoggio e
zona di scolo dell'acqua.

Stripe semifilotop

Codice

Versione

Caratteristiche

Prezzo

Base 80/(90)^T (rif. pag. 16)

4504 051 dx
4504 052 sx



incasso: 1140 x 480



- Acciaio AISI 304 satinato
- Dimensioni: **1173 x 513** - 1 vasca: **750 x 350**
- Piletta automatica 3/2" PM

In dotazione: **elemento portacoltelli**
Accessori, disegno tecnico a pag. 166

In foto versione sinistra

Base 80/(90)^T (rif. pag. 16)

4503 051 dx
4503 052 sx



incasso: 1140 x 480



- Acciaio AISI 304 satinato
- Dimensioni: **1173 x 513** - 2 vasche: **365 x 350**
- Piletta automatica 3/2" PM
- Possibilità fori aggiuntivi

Accessori, disegno tecnico a pag. 166

In foto versione sinistra

Base 60

4500 051 dx
4500 052 sx



incasso: 840 x 480



- Acciaio AISI 304 satinato
- Dimensioni: **873 x 513** - 1 vasca: **500 x 350**
- Piletta automatica 3/2" PM
- Possibilità fori aggiuntivi

Accessori, disegno tecnico a pag. 166

In foto versione sinistra

Stripe semifilotop

Codice

Versione

Caratteristiche

Prezzo

■ **Base 80/(90)^T** (rif. pag. 16)

4502 050



incasso: 840 x 480



- Acciaio AISI 304 satinato
- Dimensioni: **873 x 513** - 2 vasche: **365 x 350**
- Piletta automatica 3½" PM
- Possibilità fori aggiuntivi

Accessori a fondo pagina

■ **Base 60**

4505 050



incasso: 570 x 480



- Acciaio AISI 304 satinato
- Dimensioni: **603 x 513** - 1 vasca: **500 x 350**
- Piletta automatica 3½" PM
- Possibilità fori aggiuntivi

Accessori a fondo pagina

accessori



B4

Griglia Black
36,8 x 34,2 cm
8100 618



P3

Tagliere in legno
Iroko 26 x 36,6 cm
8643 117

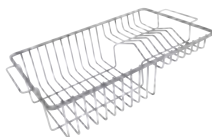

T6

Griglia portapiatti
inox 23 x 37,5
8100 305

4504 051 **B4** **P3** **T6**
4504 052

4503 051 **P3** **T6**
4503 052

4500 051 **B4** **P3** **T6**
4500 052

4502 050 **P3** **T6**

4505 050 **B4** **P3** **T6**

4504 051 dx | 4504 052 sx

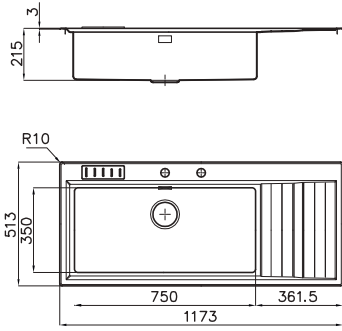

4503 051 dx | 4503 052 sx

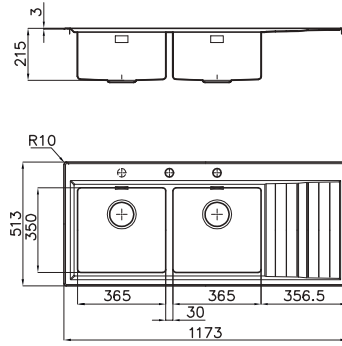

4500 051 dx | 4500 052 sx

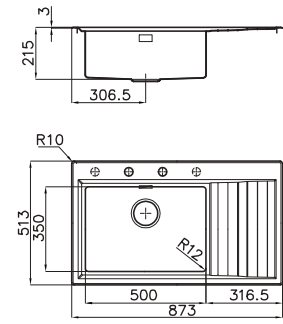

4502 050

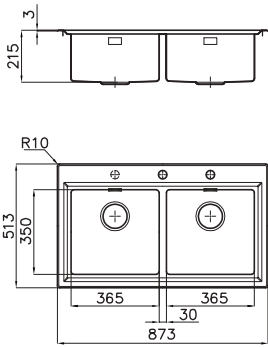

4505 050

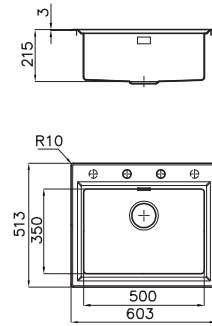

Serie **EVO** **NEW**
standard



Serie EVO

La vasca più grande
di tutta la produzione Foster

Serie EVO NEW

standard

Codice

Versione

Caratteristiche

Prezzo

Base 90



3216 051 dx
3216 052 sx



incasso: 1140 x 480

- Acciaio AISI 304 satinato
- Dimensioni: **1160 x 500** - 1 vasca: **730 x 400**
- Piletta 3½"
- Possibilità fori aggiuntivi
- Versione Plus con vasca profonda

Accessori, disegno tecnico
e pilette automatiche a pag. 172

In foto versione sinistra

Base 90 NEW



3219 051 dx
3219 052 sx



incasso: 1140 x 480

- Acciaio AISI 304 satinato
- Dimensioni: **1160 x 500** - 1 vasca: **730 x 400**
- Piletta 3½"
- Possibilità fori aggiuntivi

Accessori, disegno tecnico
e pilette automatiche a pag. 172

In foto versione sinistra

Base 80/(90)^T (rif. pag. 16)



3212 051 dx
3212 052 sx



incasso: 1140 x 480

- Acciaio AISI 304 satinato
- Dimensioni: **1160 x 500** - 2 vasche: **340 x 400**
- Piletta 3½"
- Possibilità fori aggiuntivi

Accessori, disegno tecnico
e pilette automatiche a pag. 172

In foto versione sinistra

Serie **EVO** **NEW**
standard



Serie EVO NEW

standard

Codice

Versione

Caratteristiche

Prezzo

Base 60



3218 001 dx
3218 002 sx



incasso: 840 x 480

- Acciaio AISI 304 satinato
- Dimensioni: **860 x 500** - 1 vasca: **450 x 400**
- Piletta 3½"
- Possibilità fori aggiuntivi

Accessori, disegno tecnico
e pilette automatiche a pag. 172

In foto versione sinistra

Base 80/(90)^T (rif. pag. 16)



3274 050



incasso: 840 x 480

- Acciaio AISI 304 satinato
- Dimensioni: **860 x 500** - 2 vasche: **340 x 400**
- Piletta 3½"

Accessori, disegno tecnico
e pilette automatiche a pag. 172

Base 60 NEW



3217 000



incasso: 560 x 480

- Acciaio AISI 304 satinato
- Dimensioni: **590 x 500** - 1 vasca: **500 x 350**
- Piletta 3½"
- Possibilità fori aggiuntivi

Accessori, disegno tecnico
e pilette automatiche a pag. 172



L4

Tagliere cristallo
23x41 cm
8631 300



L5

Tagliere cristallo
29x54 cm
8633 300



P3

Tagliere
26x36,6 cm
8643 117



N2

Tagliere in HDPE
27,2x42,5 cm
8657 001



N3

Tagliere Twin
in HDPE 31,7x41,8
8644 101



O2

Vaschetta bianca
27,2x41,4 cm
8153 100



K7

Kit tagliere in legno
Iroko 42 x 31,7 cm
con vaschetta
scolapasta
in acciaio inox
8644 044



K8 *

Kit grattugie con
anello-supporto e
vaschetta vivande
8159 101



Z4

Scolapasta bianco
17x32 cm
8151 100



R2

Cestello in inox
34x40 cm
8611 000



R3

Cestello in inox
40x40 cm
8612 000



T6

Griglia
portapiatti in inox
23x37,5 cm
8100 305

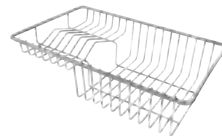

T2 *

Cestello portapiatti
in inox 21,4x37,9 cm
8100 303



Z2 *

Vaschetta forata
in inox 21,5x38 cm
8151 000

Disponibile anche in versione PVD



Gun Metal
8151 006



Copper
8151 008



Gold
8151 009

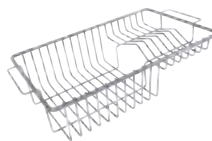

T1

Cestello portapiatti
in inox 25x42,5 cm
8100 201

3219 051 **L4 L5 N3 O2 K8 R3 T2 Z4**
3219 052 **N2 R2 K7 Z2 T1**

3216 051 **L4 L5 N3 O2 K8 R3 T2 Z4**
3216 052 **N2 R2 K7 Z2 T1**

3212 051 **L4 L5 N3 O2 K8 R3 T2 Z4**
3212 052 **N2 R2 K7 Z2 T1**

3218 001 **L4 L5 N3 O2 K8 R3 T2 Z4**
3218 002 **N2 R2 K7 Z2 T1**

3274 050 **L4 L5 N3 O2 K8 R3 T2 Z4**
Z4 N2 R2 K7 Z2 T1

3217 000 **T6 P3 O2 Z4 Z2**

pilette automatiche opzionali

3219 051 **PR**
3219 052

3216 051 **PA PE PM PL PP**
3216 052

3212 051 **PA PE PM PL PP**
3212 052

3218 001 **PR**
3218 002

3274 050 **PA PE PM PL PP**

3217 000 **PR**

Vedi pag. 298

* utilizzabile solo in abbinamento al tagliere N3

Serie EVO

disegni tecnici

3216 051 dx | 3216 052 sx

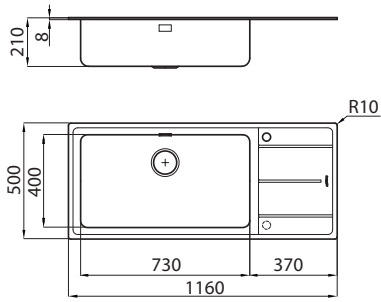

3219 051 dx | 3219 052 sx **NEW**

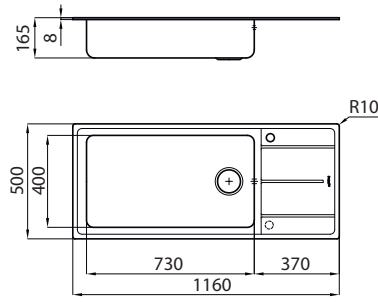

3212 051 dx | 3212 052 sx

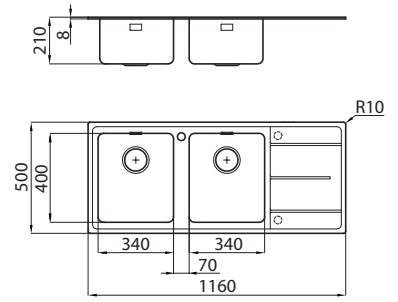

3218 001 dx | 3218 002 sx

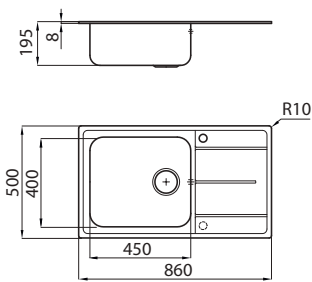

3274 050

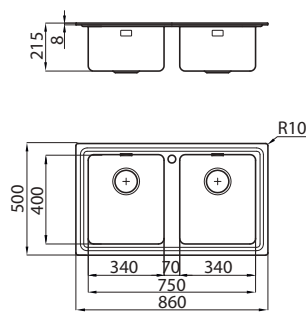

3217 000 **NEW**

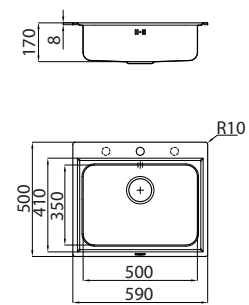

Elettra

standard



■ Base 80/(90)^T (rif. pag. 16)



Accessori, disegno tecnico
e pilette automatiche a pag. 176

In foto versione sinistra

Codice	Versione	Caratteristiche	Prezzo
--------	----------	-----------------	--------

5812 061 dx 5812 062 sx	 STD	incasso: 1140 x 480	
----------------------------	---	---------------------	--

- Acciaio AISI 304 satinato
- Dimensioni: 1160 x 500 - 2 vasche: 340 x 400
- Piletta 3½"
- Possibilità fori aggiuntivi

Elettra standard

Codice

Versione

Caratteristiche

Prezzo

Base 60



5197 061 dx
5197 062 sx



incasso: 950 x 480

- Acciaio AISI 304 satinato
- Dimensioni: **970 x 500** - 2 vasche: **340 x 400 + 150 x 300**
- Piletta 3½"
- Possibilità fori aggiuntivi

Accessori, disegno tecnico
e pilette automatiche a pag. 176

In foto versione sinistra

Base 80/(90)^T (rif. pag. 16)



5886 060



incasso: 840 x 480

- Acciaio AISI 304 satinato
- Dimensioni: **860 x 500** - 2 vasche: **340 x 400**
- Piletta 3½"

Accessori e disegno tecnico a pag. 176

Base 45



5186 061 dx
5186 062 sx



incasso: 840 x 480

- Acciaio AISI 304 satinato
- Dimensioni: **860 x 500** - 1 vasca: **340 x 400**
- Piletta 3½"
- Possibilità fori aggiuntivi

Accessori, disegno tecnico
e pilette automatiche a pag. 176

In foto versione sinistra

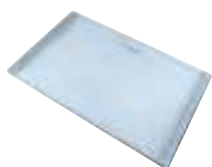

L4

Tagliere cristallo
23x41 cm
8631 300



L5

Tagliere in cristallo
29x54 cm
8633 300



N2

Tagliere in HDPE
27,2x42,5 cm
8657 001



O2

Vaschetta bianca
27,2x41,4 cm
8153 100



Z4

Scolapasta bianco
17x32 cm
8151 100



R2

Cestello Inox
34x40 cm
8611 000



Z1

Scolapasta inox
17x32 cm
8154 043



K7

Kit tagliere in legno
Iroko 42 x 31,7 cm
con vaschetta
scolapasta
in acciaio inox
8644 044

5812 061 **L4 L5 N2 O2 R2 K7 Z4**
5812 062

5197 061 **L4 L5 N2 O2 Z4 R2 Z1 K7**
5197 062

5886 060 **L4 L5 N2 O2 R2 K7 Z4**

5186 061 **L4 L5 N2 O2 R2 K7 Z4**
5186 062

pilette automatiche opzionali

5812 061 **PR PC PQ**
5812 062

5197 061 **PR PC PQ**
5197 062

5886 060 **PR PC PQ**

5186 061 **PR PC PQ**
5186 062

Vedi pag. 298

5812 061 dx | 5812 062 sx

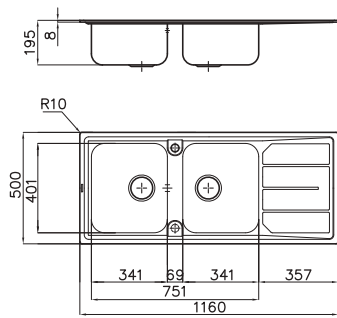

5197 061 dx | 5197 062 sx

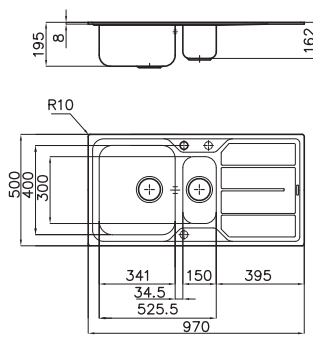

5886 060

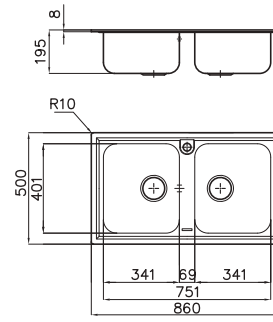

5186 061 dx | 5186 062 sx

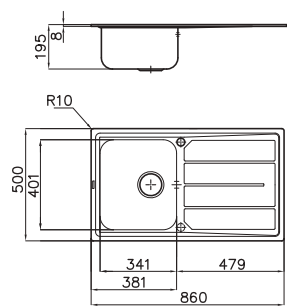

FM

standard



La **continuità della superficie**
senza punti di saldatura garantisce
pulizia e robustezza

Vasche capienti
e **Gocciolatoio salvagoccia**

FM standard

Codice

Versione

Caratteristiche

Prezzo

■ **Base 80/(90)^T** (rif. pag. 16)

1972 061 dx
1972 062 sx



incasso: 1140 x 480



- Acciaio AISI 304 satinato
- Dimensioni: **1160 x 500** - 2 vasche: **362,5 x 400**
- Piletta 3½"
- Possibilità fori aggiuntivi

Accessori, disegno tecnico
e pilette automatiche a pag. 182

In foto versione sinistra

■ **Base 80/(90)^T** (rif. pag. 16)

1974 060



incasso: 840 x 480



- Acciaio AISI 304 satinato
- Dimensioni: **860 x 500** - 2 vasche: **362,5 x 400**
- Piletta 3½"

Accessori e disegno tecnico a pag. 182

■ **Base 45**

1971 061 dx
1971 062 sx



incasso: 840 x 480



- Acciaio AISI 304 satinato
- Dimensioni: **860 x 500** - 1 vasca: **362,5 x 400**
- Piletta 3½"
- Possibilità fori aggiuntivi

Accessori, disegno tecnico
e pilette automatiche a pag. 182

In foto versione sinistra

FM Marine

standard



Acciaio AISI 316

Migliore resistenza alla salsedine, ai detersivi, agli acidi degli alimenti

L'assenza di saldature

conferisce al prodotto una maggiore uniformità superficiale priva di porosità, un'elevata rimovibilità batterica e resistenza alla corrosione



FM Marine standard

Codice

Versione

Caratteristiche

Prezzo

■ **Base 80/(90)^T** (rif. pag. 16)

1972 961 dx
1972 962 sx



incasso: 1140 x 480



- Acciaio AISI 316 satinato
- Dimensioni: **1160 x 500** - 2 vasche: **362,5 x 400**
- Piletta 3½"
- Possibilità fori aggiuntivi

Accessori, disegno tecnico
e pilette automatiche a pag. 182

In foto versione sinistra

■ **Base 80/(90)^T** (rif. pag. 16)

1974 960



incasso: 840 x 480



- Acciaio AISI 316 satinato
- Dimensioni: **860 x 500** - 2 vasche: **362,5 x 400**
- Piletta 3½"

Accessori e disegno tecnico a pag. 182

■ **Base 45**

1971 961 dx
1971 962 sx



incasso: 840 x 480



- Acciaio AISI 316 satinato
- Dimensioni: **860 x 500** - 1 vasca: **362,5 x 400**
- Piletta 3½"
- Possibilità fori aggiuntivi

Accessori, disegno tecnico
e pilette automatiche a pag. 182

In foto versione sinistra



L4

Tagliere cristallo
23x41 cm
8631 300



L5

Tagliere in cristallo
29x54 cm
8633 300



N2

Tagliere in HDPE
27,2x42,5 cm
8657 001



R2

Cestello Inox
34x40 cm
8611 000

1972 061 **L4 L5 N2 R2**
1972 062
1972 961
1972 962

1974 060 **L4 L5 N2 R2**
1974 960

1971 061 **L4 L5 N2 R2**
1971 062
1971 961
1971 962

pilette automatiche opzionali

1972 061 **PR PC PQ**
1972 062
1972 961
1972 962

1971 061 **PR PC PQ**
1971 062
1971 961
1971 962

Vedi pag. 298

1972 061 dx | 1972 062 sx
1972 961 dx | 1972 962 sx

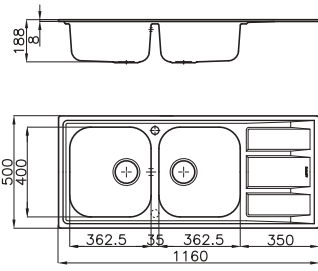

1974 060
1974 960

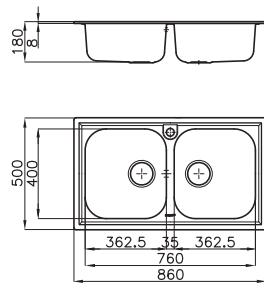

1971 061 dx | 1971 062 sx
1971 961 dx | 1971 962 sx

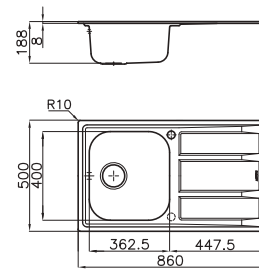

Big Bowl

standard



Base 60



Accessori, disegno tecnico
e pilette automatiche a pag. 186

In foto versione sinistra

Codice

1513 201 dx
1513 202 sx

Versione



Caratteristiche

incasso: 1140 x 480

Prezzo

- Acciaio AISI 304 satinato
- Dimensioni: **1160 x 500** - 1 vasca: **450 x 400**
- Piletta 3½"
- Possibilità fori aggiuntivi

Base 90



Accessori, disegno tecnico
e pilette automatiche a pag. 186

1562 001 dx
1562 002 sx



incasso: 840 x 480

- Acciaio AISI 304 satinato
- Dimensioni: **STD 860 x 500** - 2 vasche: **450 x 400 + 275 x 400**
- Piletta 3½"
- Possibilità fori aggiuntivi

Big Bowl standard

Codice

Versione

Caratteristiche

Prezzo

■ Base 60

1561 201 dx
1561 202 sx



incasso: 840 x 480



- Acciaio AISI 304 satinato
- Dimensioni: **860 x 500** - 1 vasca: **450 x 400**
- Piletta 3½"
- Possibilità fori aggiuntivi

Accessori, disegno tecnico
e pilette automatiche a pag. 186

In foto versione sinistra

■ Base 60

1511 001 dx
1511 002 sx



incasso: 570 x 480



- Acciaio AISI 304 satinato
- Dimensioni: **590 x 500** - 1 vasca: **450 x 400**
- Piletta 3½"
- Possibilità fori aggiuntivi

Accessori, disegno tecnico
e pilette automatiche a pag. 186

In foto versione sinistra

■ Base 60

1611 060



incasso: 530 x 480 R 135



- Acciaio AISI 304 satinato
- Dimensioni: **550 x 500** - 1 vasca: **450 x 400**
- Piletta 3½"

Accessori, disegno tecnico
e pilette automatiche a pag. 186

Big Bowl

accessori



L4

Tagliere cristallo
23x41 cm
8631 300



L5

Tagliere in cristallo
29x54 cm
8633 300



N2

Tagliere in HDPE
27,2x42,5 cm
8657 001



R3

Cestello Inox
40x40 cm
8612 000

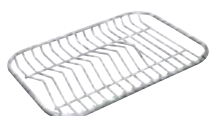

T3

Griglia portapiatti
inox 28x40 cm
8100 280

1513 201 L4 L5 N2 R3
1513 202

1562 001 L4 L5 N2 R3 T3
1562 002

1561 201 L4 L5 N2 R3
1561 202

1511 001 L4 L5 N2 R3
1511 002

1611 060 L4 N2 R3

pilette automatiche opzionali

1513 201 PR PQ PC
1513 202

1562 001 PR PQ PC
1562 002

1561 201 PR PQ PC
1561 202

1511 001 PR PQ PC
1511 002

1611 060 PR PQ PC

Vedi pag. 298

Big Bowl

disegni tecnici

1513 201 dx | 1513 202 sx

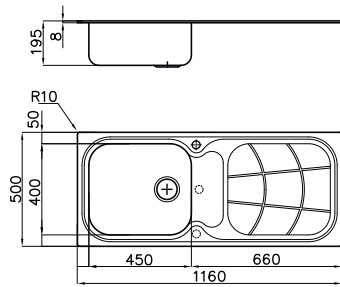

1562 001 dx | 1562 002 sx

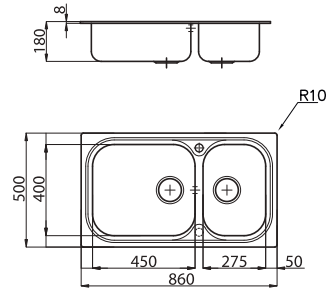

1561 201 dx | 1561 202 sx

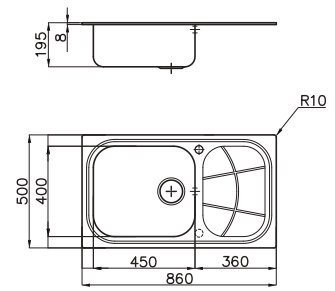

1511 001 dx | 1511 002 sx

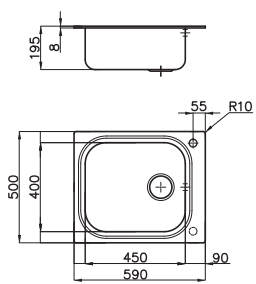

1611 060

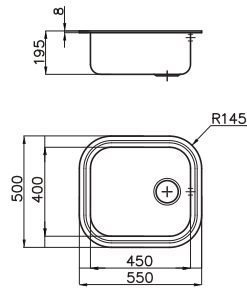

LAVELLI

Uragano

standard



■ Base 100



Codice

1555 600

Versione

 **STD**

Caratteristiche

incasso: 950 x 480

Prezzo

- Acciaio AISI 304 satinato
- Dimensioni: **970 x 500** - 1 vasca: **910 x 440**
- Piletta 3½"

Accessori e disegno tecnico a pag. 190

Tornado

standard



LAVELLI

Base 80



Codice

1579 660

Versione

 STD

Caratteristiche

incasso: 770 x 480

Prezzo

- Acciaio AISI 304 satinato
- Dimensioni: **790 x 500** - 1 vasca: **730 x 400**
- Piletta automatica 3½"
- Possibilità fori aggiuntivi

Accessori e disegno tecnico a pag. 190

Base 80



1679 660

 STD

incasso: 770 x 480 R 135

- Acciaio AISI 304 satinato
- Dimensioni: **790 x 500** - 1 vasca: **730 x 400**
- Piletta automatica 3½"
- Possibilità fori aggiuntivi

Accessori e disegno tecnico a pag. 190



P5

Tagliere in legno
Iroko 37x30 cm
8659 111



L5

Tagliere in cristallo
29x54 cm
8633 300



P4

Tagliere Twin in legno
Iroko 37x46 cm
8644 003



O1

Vaschetta bianca
36x30 cm
8152 100



Z4

Scolapasta bianco
17x32 cm
8151 100



T *

Griglia portapiatti
inox 25x35 cm
8100 154



T7

Griglia portapiatti
inox 25x45 cm
8100 111



R1

Portavaschetta
37x45 cm
8100 112

Uragano
1555 600 **P5 L5 P4 O1 Z4 T T7 R1**

Tornado
1579 660 **P5 L5 P4 O1 Z4 T T7 R1**

1679 660 **P5 L5 P4 O1 Z4 T T7 R1**

* utilizzabile solo in abbinamento al tagliere P4

Uragano

disegni tecnici

1555 600

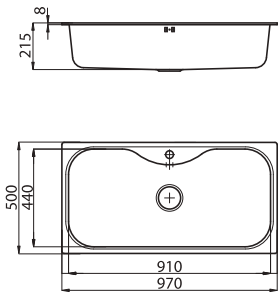

Tornado

disegni tecnici

1579 660

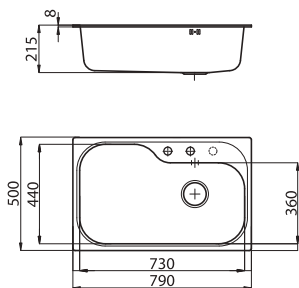

1679 660

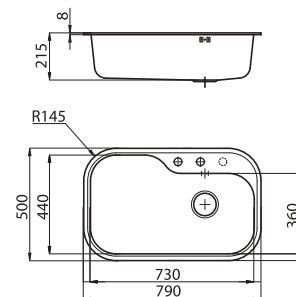

Angolare

standard

NEW



Base 90 x90



Accessori, disegno tecnico
e pilette automatiche a pag. 194

Codice

3303 060

Versione

 **STD**

Caratteristiche

incasso: vedi sito web

Prezzo

- Acciaio AISI 304 satinato
- Dimensioni: **830 x 830** - 2 vasche: **340 x 400**
- Piletta 3½"

Base 90 lineare



Accessori, disegno tecnico
e pilette automatiche a pag. 194

3308 050

 **STD**

incasso: vedi sito web

- Acciaio AISI 304 satinato
- Dimensioni: **830 x 830** - 2 vasche: **400 x 400 - 180 x 340**
- Piletta 3½" + 1¼" su gocciolatoio
- Possibilità fori aggiuntivi



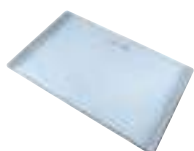

L4

Tagliere in cristallo
23x41 cm
8631 300

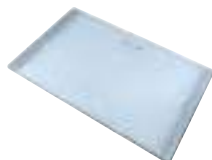

L5

Tagliere in cristallo
29x54 cm
8633 300



N2

Tagliere in HDPE
27,2x42,5 cm
8657 001



N3

Tagliere Twin
in HDPE 31,7x41,8
8644 101



O2 *

Vaschetta bianca
27,2x41,4 cm
8153 100



K7

Kit tagliere in legno
Iroko 42 x 31,7 cm
con vaschetta
scolapasta
in acciaio inox
8644 044



K8 *

Kit grattugie con
anello-supporto e
vaschetta vivande
8159 101



R2

Cestello Inox
34x40 cm
8611 000



T1

Cestello portapiatti
inox 25x42,5 cm
8100 201



Z2 *

Vaschetta forata inox
21,5x38 cm
8151 000

Disponibile anche in versione PVD



Gun Metal
8151 006



Copper
8151 008



Gold
8151 009

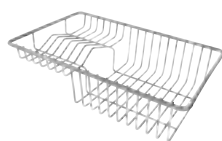

T2 *

Cestello portapiatti
inox 21,4x37,9 cm
8100 303

3303 060 **L5** **N2** **O2** **R2**

3308 050 **L4** **L5** **N2** **N3** **O2** **R2** **K7** **K8**
T1 **Z2** **T2**

pilette automatiche opzionali

3308 050 **PR** **PQ** **PC**

Vedi pag. 298

* utilizzabile solo in abbinamento al tagliere N3

3303 060

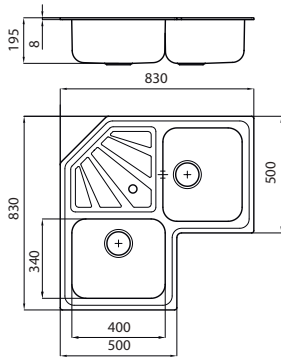

3308 050

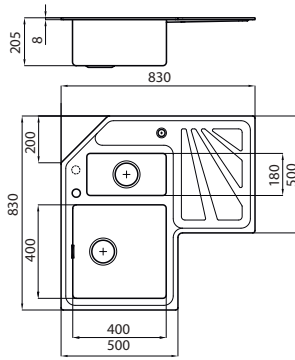

S1000

standard



S1000

standard

Codice

Versione

Caratteristiche

Prezzo

Base 80/(90)^T (rif. pag. 16)



1812 161 dx
1812 162 sx



incasso: 1140 x 480

- Acciaio AISI 304 satinato
- Dimensioni: **1160 x 500** - 2 vasche: **360 x 400**
- Piletta 3 1/2"
- Possibilità fori aggiuntivi

Accessori, disegno tecnico
e pilette automatiche a pag. 200

In foto versione sinistra

Base 60/(80)^T (rif. pag. 16)



1197 161 dx
1197 162 sx



incasso: 950 x 480

- Acciaio AISI 304 satinato
- Dimensioni: **970 x 500** - 2 vasche: **340 x 400 + 170 x 340**
- Piletta 3 1/2"
- Possibilità fori aggiuntivi

- Disponibile anche in versione **Microfoster**
1197 461 dx
1197 462 sx



Accessori, disegno tecnico
e pilette automatiche a pag. 200

In foto versione sinistra

Base 45



1186 161 dx
1186 162 sx



incasso: 840 x 480

- Acciaio AISI 304 satinato
- Dimensioni: **860 x 500** - 1 vasca: **340 x 400**
- Piletta 3 1/2"
- Possibilità fori aggiuntivi

Accessori, disegno tecnico
e pilette automatiche a pag. 200

In foto versione sinistra

S1000

standard

Codice

Versione

Caratteristiche

Prezzo

■ **Base 80/(90)^T** (rif. pag. 16)

1886 160



incasso: 840 x 480



- Acciaio AISI 304 satinato
- Dimensioni: **860 x 500** - 2 vasche: **360 x 400**
- Piletta 3 ½"

Accessori e disegno tecnico a pag. 200

■ **Base 80**

1279 060



incasso: 770 x 480



- Acciaio AISI 304 satinato
- Dimensioni: **790 x 500** - 2 vasche: **360 x 400**
- Piletta 3 ½"

Accessori e disegno tecnico a pag. 200

■ **Base 45**

1179 061 dx
1179 062 sx



incasso: 770 x 480



- Acciaio AISI 304 satinato
- Dimensioni: **790 x 500** - 1 vasca: **340 x 400**
- Piletta 3 ½"
- Possibilità fori aggiuntivi

Accessori, disegno tecnico
e pilette automatiche a pag. 200

In foto versione sinistra

S1000

standard

Codice

Versione

Caratteristiche

Prezzo

Base 45



1144 001 dx
1144 002 sx



incasso: 420 x 480

- Acciaio AISI 304 satinato
- Dimensioni: **440 x 500** - 1 vasca: **360 x 360**
- Piletta 2"
- Possibilità fori aggiuntivi

1144 061 dx
1144 062 sx



incasso: 420 x 480

- Acciaio AISI 304 satinato
- Dimensioni: **440 x 500** - 1 vasca: **360 x 360**
- Piletta 3 1/2"
- Possibilità fori aggiuntivi

Per versione dx si intende foro miscelatore a destra;
le versioni sx hanno foro a sinistra.
Disegno tecnico a pag. 200

Base 30



1129 000



incasso: 270 x 480

- Acciaio AISI 304 satinato
- Dimensioni: **290 x 340** - 1 vasca: **240 x 340**
- Piletta 2"

Disegno tecnico a pag. 200

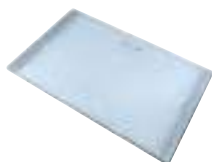

L5

Tagliere in cristallo
29x54 cm
8633 300



N2

Tagliere in HDPE
27,2x42,5 cm
8657 001



R2

Cestello Inox
34x40 cm
8611 000

1812 161 L5 N2 R2
1812 162

1197 161 L5 N2 R2
1197 162

1186 161 L5 N2 R2
1186 162

1886 160 L5 N2 R2

1279 060 L5 N2 R2

1179 061 L5 N2 R2
1179 062

pilette automatiche opzionali

1812 161 PR PQ PC
1812 162

1197 161 PR PQ PC
1197 162

1186 161 PR PQ PC
1186 162

1179 061 PR PQ PC
1179 062

Vedi pag. 298

S1000 | disegni tecnici

1812 161 dx | 1812 162 sx

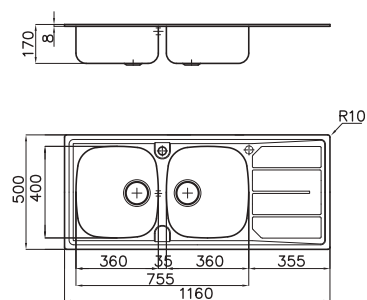

1197 161 dx | 1197 162 sx

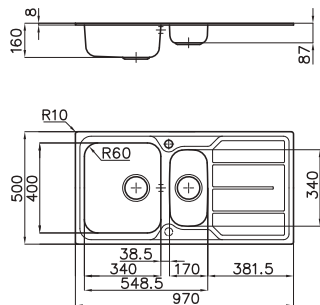

1186 161 dx | 1186 162 sx

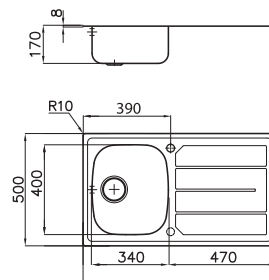

1886 160

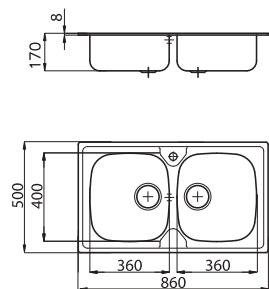

1279 060

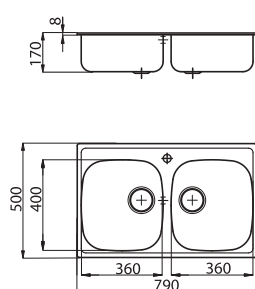

1179 061 dx | 1179 062 sx

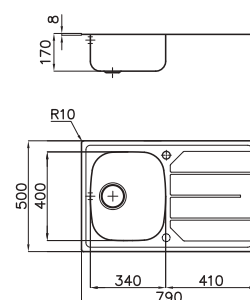

1144 001 dx | 1144 002 sx
1144 061 dx | 1144 062 sx

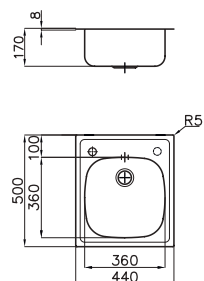

1129 000

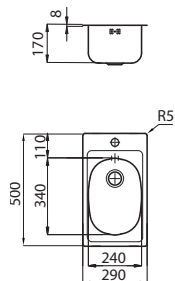

Monovasca S1000

BR



Base 80

Codice

1180 150

Versione



Caratteristiche

incasso: 840 x 480

Prezzo



- Acciaio AISI 304 satinato
- Dimensioni: **865 x 505** - 1 vasca: **726 x 350**
- Piletta 3½"
- Possibilità fori aggiuntivi

• Disponibile anche in versione **Gun Metal**

Gun Metal
1180 156



pag. 33

accessori



L5

Tagliere cristallo
29x54 cm
8633 300



P3

Tagliere
26 x 36,6 cm
8643 117

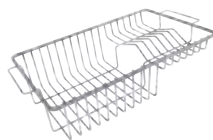

T6

Griglia portapiatti
inox 23 x 37,5
8100 305

pilette automatiche opzionali

PA PE PM PL PP PS

Vedi pag. 298

disegno tecnico

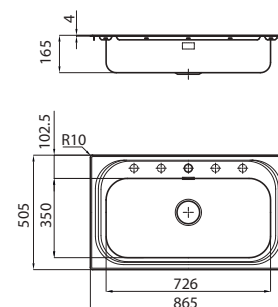

Lavelli e vasche | Sottotop





Lavelli e vasche | Sottotop



210	Phantom Base <small>NEW</small>	260	Serie 45
216	Phantom <small>NEW</small>	262	Serie 35
222	Milanello workstation	264	KE R15 <small>NEW</small>
228	Foster Milano	272	KE R15 con fissaggio facilitato <small>NEW</small>
234	Quadra EVO <small>NEW</small>	276	S400
240	Quadra R12 <small>NEW</small>	278	Big Bowl
246	Quadra <small>NEW</small>	280	Tornado
252	Circolari <small>NEW</small>	282	KS R60 <small>NEW</small>
254	S4001 <small>NEW</small>		

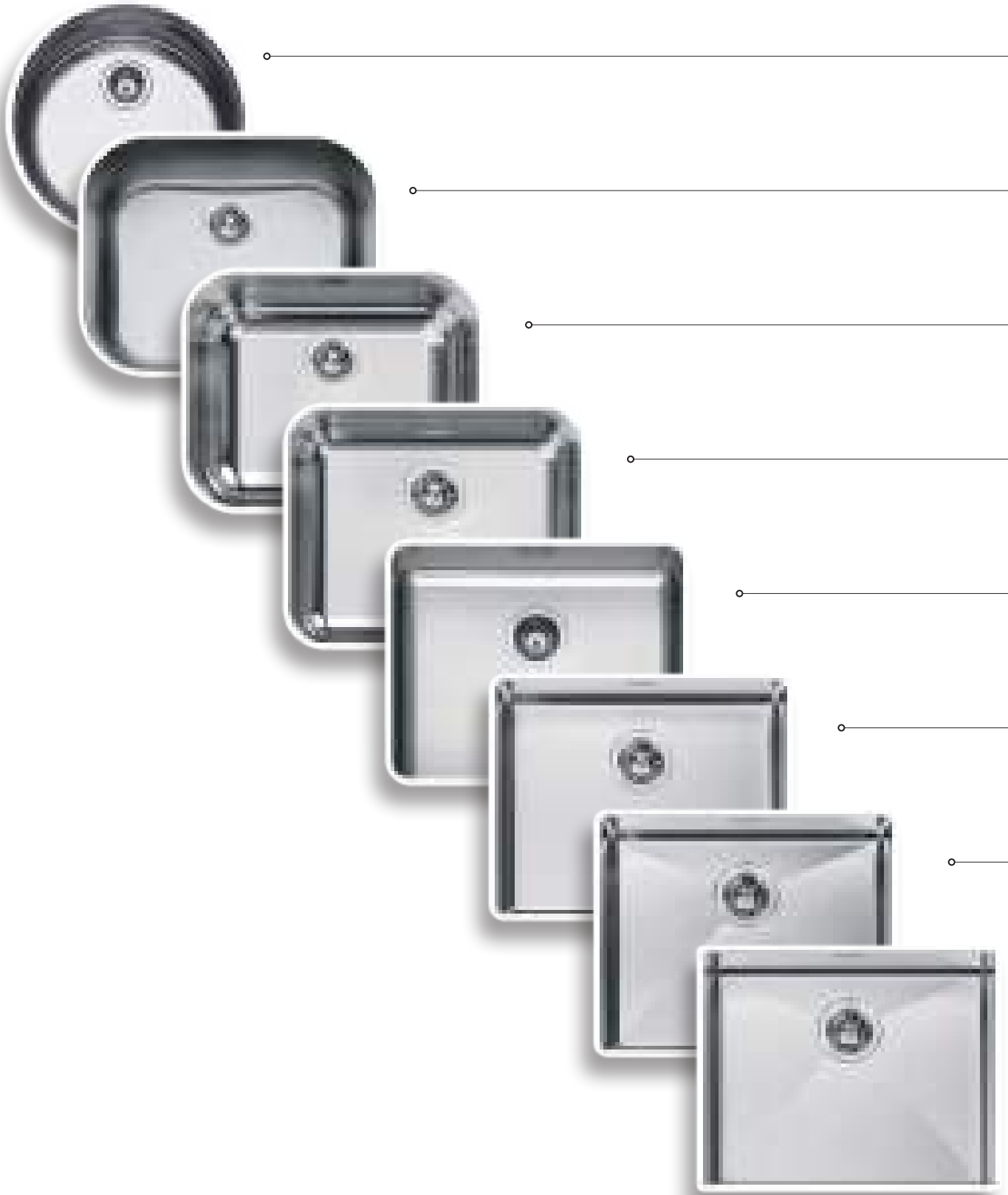

Diametro 380
Circolari

Raggio 115
Tornado

Raggio 95-50
Big Bowl

Raggio 60
KS

Raggio 30
S400

Raggio 15
KE

Raggio 12
Phantom, S4001,
Quadra R12,
Serie 45, Serie 35

Raggio 0
Milanello, Milano,
Phantom Base,
Quadra EVO, Quadra

Phantom Base **NEW**
sottotop





Le pareti di contenimento sono piegate e saldate negli angoli per garantire la tenuta all'acqua e facilitare l'installazione delle lastre che compongono la vasca



Il corretto svuotamento dell'acqua grazie all'inclinazione del fondo verso il centro dello scarico



Il fondo delle vasche realizzato tramite stampaggio facilita le operazioni di pulizia grazie alle pareti laterali inclinate

Phantom Base

sottotop



Codice

Versione

Caratteristiche

Prezzo

Base 80



Accessori, disegno tecnico
e pilette automatiche a pag. 214

5557 240



PB 20

Per lastre spessore 20 mm
Dimensioni: **756 x 446**
1 vasca: **716 x 406**

- Incasso: vedi sito web
- Fondo in acciaio AISI 304 satinato
- Piletta 3½" + tubo corrugato universale per l'installazione di differente troppo pieno

• Disponibile anche in versione PVD

Gun Metal
5557 246



pag. 22

Copper
5557 248



pag. 46

Gold
5557 249



pag. 64

Base 60



Accessori, disegno tecnico
e pilette automatiche a pag. 214

5555 240



PB 20

Per lastre spessore 20 mm
Dimensioni: **546 x 446**
1 vasca: **506 x 406**

- Incasso: vedi sito web
- Fondo in acciaio AISI 304 satinato
- Piletta 3½" + tubo corrugato universale per l'installazione di differente troppo pieno

• Disponibile anche in versione PVD

Gun Metal
5555 246



pag. 22

Copper
5555 248



pag. 46

Gold
5555 249



pag. 64

Base 60



Accessori, disegno tecnico
e pilette automatiche a pag. 214

5554 240



PB 20

Per lastre spessore 20 mm
Dimensioni: **446 x 446**
1 vasca: **406 x 406**

- Incasso: vedi sito web
- Fondo in acciaio AISI 304 satinato
- Piletta 3½" + tubo corrugato universale per l'installazione di differente troppo pieno

• Disponibile anche in versione PVD

Gun Metal
5554 246



pag. 22

Copper
5554 248



pag. 46

Gold
5554 249



pag. 64

Phantom Base sottotop

NEW

Codice

Versione

Caratteristiche

Prezzo

Base 80



5557 340



Per lastre spessore 12 mm
Dimensioni: **740 x 430**
1 vasca: **716 x 406**

- Incasso: vedi sito web
- Fondo in acciaio AISI 304 satinato
- Piletta 3½" + tubo corrugato universale per l'installazione di differente troppo pieno

• Disponibile anche in versione PVD

Gun Metal
5557 346



pag. 22

Copper
5557 348



pag. 46

Gold
5557 349



pag. 64

Accessori, disegno tecnico e pilette automatiche a pag. 214

Base 60



5555 340



Per lastre spessore 12 mm
Dimensioni: **530 x 430**
1 vasca: **506 x 406**

- Incasso: vedi sito web
- Fondo in acciaio AISI 304 satinato
- Piletta 3½" + tubo corrugato universale per l'installazione di differente troppo pieno

• Disponibile anche in versione PVD

Gun Metal
5555 346



pag. 22

Copper
5555 348



pag. 46

Gold
5555 349



pag. 64

Accessori, disegno tecnico e pilette automatiche a pag. 214

Base 60



5554 340



Per lastre spessore 12 mm
Dimensioni: **430 x 430**
1 vasca: **406 x 406**

- Incasso: vedi sito web
- Fondo in acciaio AISI 304 satinato
- Piletta 3½" + tubo corrugato universale per l'installazione di differente troppo pieno

• Disponibile anche in versione PVD

Gun Metal
5554 346



pag. 22

Copper
5554 348



pag. 46

Gold
5554 349



pag. 64

Accessori, disegno tecnico e pilette automatiche a pag. 214

Phantom Base **NEW**

accessori



O2

Vaschetta bianca
27,2x41,4 cm
8153 100



N2

Tagliere in HDPE
27,2x42,5 cm
8657 001



B6

Griglia Black
38x38 cm
8100 651



B7

Griglia Black
38x48 cm
8100 652



B8

Griglia Black
38x69 cm
8100 653



R3

Cestello Inox
40x40 - 8612 000



T1

Cestello portapiatti
inox 25x42,5 cm
8100 201

5557 340 **O2 N2 B8 R3 T1**
5557 240

5555 340 **O2 N2 B7 R3 T1**
5555 240

5554 340 **O2 N2 B6 R3 T1**
5554 240

pilette automatiche opzionali

5557 340 **PL PP PA PR**
5557 240

5555 340 **PL PP PA PR**
5555 240

5554 340 **PL PP PA PR**
5554 240

Vedi pag. 298

5557 340

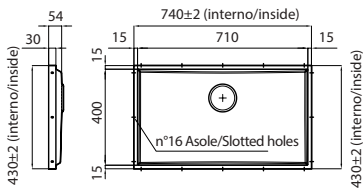

5555 340

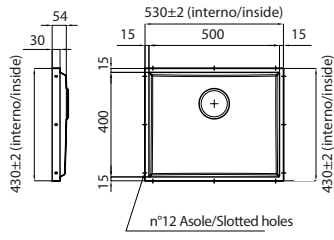

5554 340

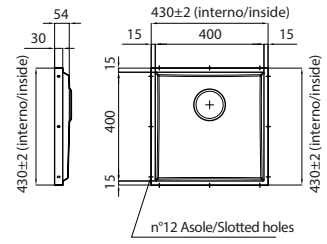

5557 240

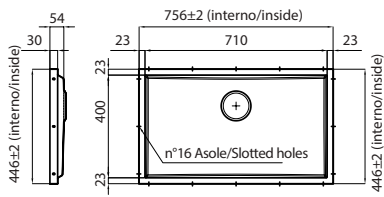

5555 240

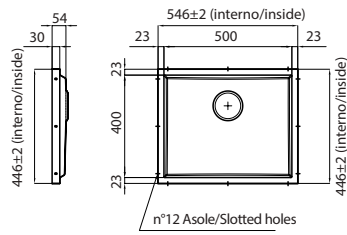

5554 240

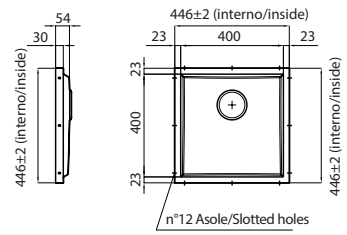

Schema di fissaggio | Disegni in sezione per il fissaggio secondo lo spessore di 12mm o di 20 mm

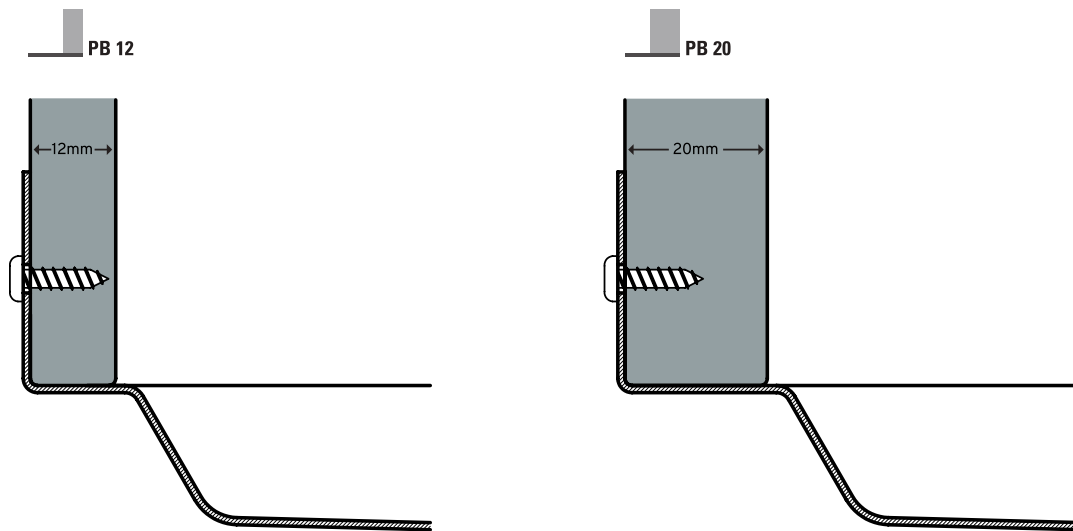

Scasso per installazione troppo pieno Foster

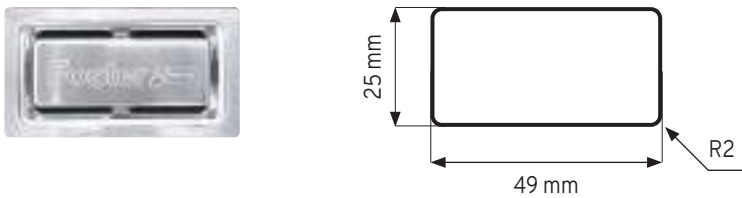

Phantom
sottotop

NEW





Il **bordo sottile** di soli 8 mm permette di creare un ribasso inferiore nei top senza che ci sia un indebolimento strutturale e quindi ridurre il bordo a vista del top



Lavelli con vasche R12



L'**installazione è molto semplice** e il ribasso a misura facilita il centraggio. Le vasche sono dotate di ganci speciali che semplificano l'installazione

Phantom

sottotop



Codice

Versione

Caratteristiche

Prezzo

Base 80

4371 051

ST

incasso: vedi sito web



- Acciaio AISI 304 satinato
- Dimensioni: **726 x 416** - 1 vasca: **710 x 400**
- Piletta 3½"

• Disponibile anche in versione **PVD**

Gun Metal
4371 056



pag. 23

Copper
4371 058



pag. 47

Gold
4371 059



pag. 65

Accessori, disegno tecnico e pilette automatiche a pag. 220

Base 60

4350 051

ST

incasso: vedi sito web



- Acciaio AISI 304 satinato
- Dimensioni: **516 x 416** - 1 vasca: **500 x 400**
- Piletta 3½"

• Disponibile anche in versione **PVD**

Gun Metal
4350 056



pag. 24

Copper
4350 058



pag. 48

Gold
4350 059



pag. 66

Accessori, disegno tecnico e pilette automatiche a pag. 220

Base 45

4340 051

ST

incasso: vedi sito web



- Acciaio AISI 304 satinato
- Dimensioni: **416 x 416** - 1 vasca: **400 x 400**
- Piletta 3½"

• Disponibile anche in versione **PVD**

Gun Metal
4340 056



pag. 24

Copper
4340 058



pag. 48

Gold
4340 059



pag. 66

Accessori, disegno tecnico e pilette automatiche a pag. 220

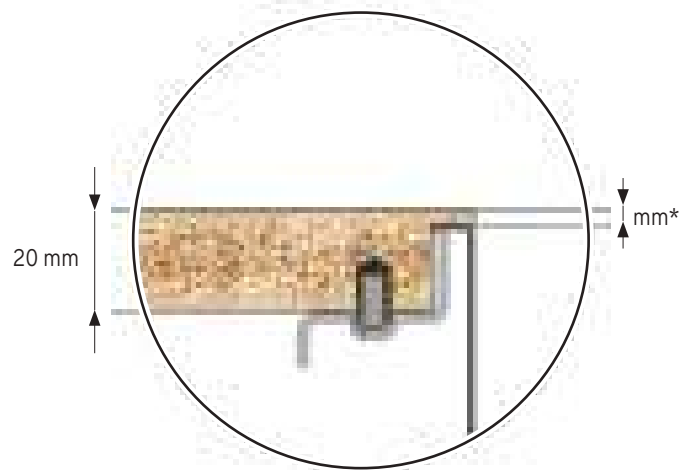
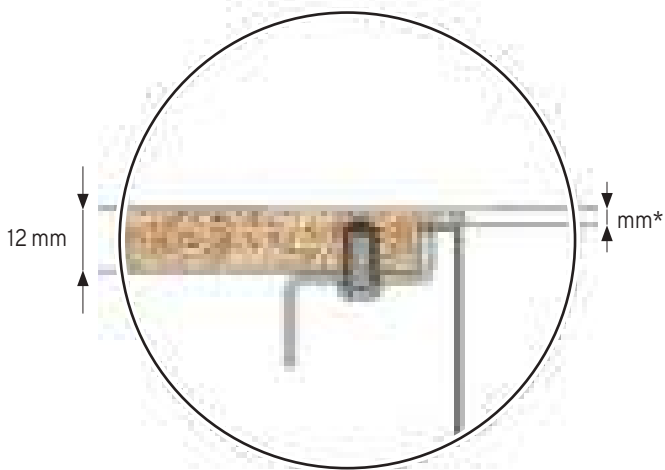

* Lo spessore minimo deve essere valutato in base alla resistenza del materiale

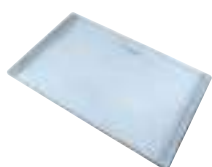

L4

Tagliere cristallo
23x41 cm
8631 300



N2

Tagliere in HDPE
27,2x42,5 cm
8657 001



N3

Tagliere Twin
in HDPE 31,7x41,8
8644 101



O2

Vaschetta bianca
27,2x41,4 cm
8153 100



K8 *

Kit grattugie con
anello-supporto e
vaschetta vivande
8159 101



B3

Griglia Black
39,2x44,8 cm
8100 617



K7

Kit tagliere in legno
Iroko con scolapasta in
acciaio inox
8644 044



B6

Griglia Black
38x38 cm
8100 651



B7

Griglia Black
38x48 cm
8100 652



B8

Griglia Black
38x69 cm
8100 653



R2

Cestello Inox
34x40 cm
8611 000



R3

Cestello Inox
40x40 - 8612 000



T1

Cestello portapiatti
inox 25x42,5 cm
8100 201

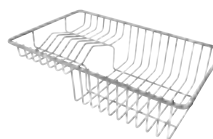

T2 *

Cestello portapiatti
inox 21,4x37,9 cm
8100 303



Z2 *

Vaschetta forata
inox 21,5x38 cm
8151 000

Disponibile anche in versione PVD



Gun Metal
8151 006



Copper
8151 008



Gold
8151 009

4371 051 L4 N2 N3 O2 K8 B3 P4 B8
R2 R3 T1 T2 Z2

4350 051 L4 N2 N3 O2 K8 B3 P4 B7
R2 R3 T1 T2 Z2

4340 051 L4 N2 N3 O2 K8 B3 P4 B6
R2 R3 T1 T2 Z2

piette automatiche opzionali

4371 051 PL PP PA PE PM

4350 051 PL PP PA PE PM

4340 051 PL PP PA PE PM

Vedi pag. 298

* utilizzabile solo in abbinamento al tagliere N3

4371 051

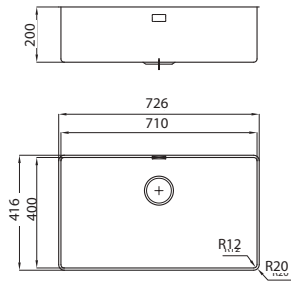

4350 051

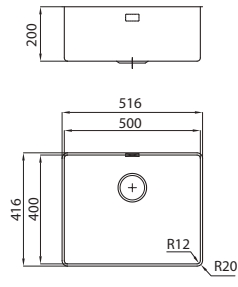

4340 051

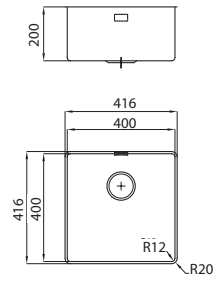

Milanello workstation

sottotop





Gamma completa di accessori

Sul secondo invaso a combinazione di accessori per rendere pratica ogni operazione: risciacquare, scolare, affettare, grattugiare... sempre all'interno del lavello.



Sistema a tre invasi

Sul primo scorrano le griglie Black: una grande superficie per risciacquare, scolare, lavorare.



Griglia di protezione sul fondo

Il terzo invaso per le griglie black è sul fondo della vasca. Per risciacquare senza venire a contatto con il fondo, o per appoggiare senza graffiare l'acciaio.



Milanello workstation

sottotop

Codice

Versione

Caratteristiche

Prezzo

Base 90

1034 850



ST

incasso: 750 x 426



- Acciaio AISI 304 satinato
- Dimensioni: **790 x 466** - 1 vasca: **750 x 374**
- Piletta SPACE 3 1/2"
- Sistema a 3 invasi

Disponibile anche in versione **PVD**

Gun Metal
1034 856



pag. 25

Copper
1034 858



pag. 49

Gold
1034 859



pag. 67

In dotazione: **2 griglie Black Milanello** (8100 602)
Accessori, disegno tecnico e pilette automatiche a pag. 226



Configurazione griglie Black a filo vasca

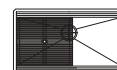

Configurazione griglie Black su fondo vasca

Base 90

1040 851 dx
1040 852 sx



ST

incasso: 750 x 426



- Acciaio AISI 304 satinato
- Dimensioni: **790 x 466** - 1 vasca: **430 x 374**
- Piletta SPACE 3 1/2"
- Sistema a 3 invasi

In dotazione: **2 griglie Black Milanello** (8100 602)
Accessori, disegno tecnico e pilette automatiche a pag. 226

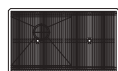

Configurazione griglie Black a filo vasca



Configurazione griglie Black su fondo vasca

Base 60

1031 850



ST

incasso: 430 x 426



- Acciaio AISI 304 satinato
- Dimensioni: **470 x 466** - 1 vasca: **430 x 374**
- Piletta SPACE 3 1/2"
- Sistema a 3 invasi

In dotazione: **1 griglia Black Milanello** (8100 602)
Accessori, disegno tecnico e pilette automatiche a pag. 226



Configurazione griglie Black a filo vasca



Configurazione griglie Black su fondo vasca



LAVELLI
SOTTOTOP

Milanello workstation | accessori

accessori opzionali scorrevoli sotto le griglie



Z3

Vaschetta forata
inox 21,5x40 cm
8156 000

LIV. 2



T8

Griglia portapiatti
inox 21,4x37,2 cm
8100 306

LIV. 2



P2

Tagliere
39,5 x 22,5 cm
in legno noce
8642 004

LIV. 2

altri accessori opzionali



L4

Tagliere cristallo
23x41 cm
8631 300

LIV. 1



N2

Tagliere in HDPE
27,2x42,5 cm
8657 001

LIV. 2



N3

Tagliere Twin
in HDPE 31,7x41,8
8644 101

LIV. 1



K8 *

Kit grattugie con
anello-supporto e
vaschetta vivande
8159 101

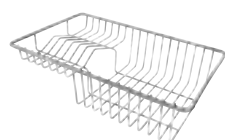

T2 *

Cestello portapiatti
inox 21,4x37,9 cm
8100 303



Z2 *

Vaschetta forata
inox 21,5x38 cm
8151 000

Disponibile anche in versione PVD



Gun Metal
8151 006



Copper
8151 008



Gold
8151 009



K7

Kit tagliere in legno
Iroko 42 x 31,7 cm
con vaschetta
scolapasta
in acciaio inox
8644 044

LIV. 1



B5

Griglia Black
37,2 x 42,4 cm
8100 602

LIV. 1 - 3
in dotazione

1034 850 **Z3 T8 L4 N2 N3 K8 T2 Z2**
K7 P2 B5

1040 851 **Z3 T8 L4 N2 N3 K8 T2 Z2**
1040 852 **K7 P2 B5**

1031 850 **Z3 T8 L4 N2 N3 K8 T2 Z2**
K7 P2 B5

pilette automatiche opzionali

1034 850 **PP**

1040 851 **PP**
1040 852

1031 850 **PP**

Vedi pag. 298

* utilizzabile solo in abbinamento agli accessori N3

1034 850

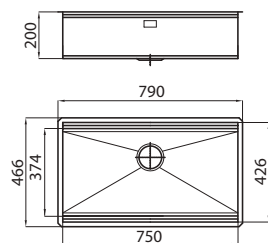

1040 851 dx | 1040 852 sx

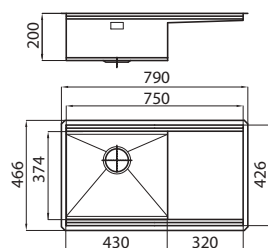

1031 850

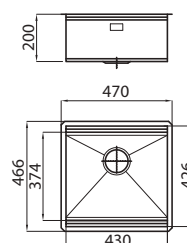

Schema di posizionamento degli accessori sugli invasi

Il sistema di "corsie" rende possibile l'utilizzo combinato di innumerevoli accessori. Griglie, tagli, portautensili, vaschette e contenitori di varie dimensioni si alternano nella zona di lavoro con un semplice gesto e possono essere impilati, sempre a portata di mano.

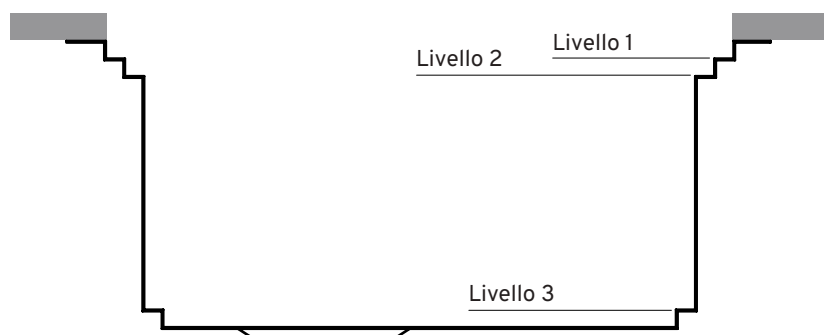

Foster Milano
sottotop





Gamma completa di accessori

Sul secondo invaso na combinazione di accessori per rendere pratica ogni operazione: risciacquare, scolare, affettare, grattugiare... sempre all'interno del livello.



Sistema a tre invasi

Sul primo scorrano le griglie Black: una grande superficie per risciacquare, scolare, lavorare.



Griglia di protezione sul fondo

Il terzo invaso per le griglie black è sul fondo della vasca. Per risciacquare senza venire a contatto con il fondo, o per appoggiare senza graffiare l'acciaio.



Foster Milano

sottotop

Codice

Versione

Caratteristiche

Prezzo

Base 120

1015 850



ST

incasso: 968 x 452



- Acciaio AISI 304 satinato
- Dimensioni: **1016 x 500** - 1 vasca: **968 x 400**
- Piletta SPACE 3 1/2"
- Sistema a 3 invasi

Accessori, disegno tecnico e pilette automatiche a pag. 232



Configurazione griglie Black a filo vasca



Configurazione griglie Black su fondo vasca

Base 120

1016 850



ST

incasso: 968 x 452



- Acciaio AISI 304 satinato
- Dimensioni: **1016 x 500** - 2 vasche: **462 x 400**
- Piletta SPACE 3 1/2"
- Sistema a 3 invasi

Accessori, disegno tecnico e pilette automatiche a pag. 232



Configurazione griglie Black a filo vasca



Configurazione griglie Black su fondo vasca

Base 90

1014 850



ST

incasso: 790 x 452



- Acciaio AISI 304 satinato
- Dimensioni: **838 x 500** - 1 vasca: **790 x 400**
- Piletta SPACE 3 1/2"
- Sistema a 3 invasi

Accessori, disegno tecnico e pilette automatiche a pag. 232

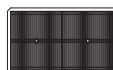

Configurazione griglie Black a filo vasca



Configurazione griglie Black su fondo vasca

Foster Milano

sottotop

Codice

Versione

Caratteristiche

Prezzo

■ Base 60

1013 850

ST

incasso: 462 x 452



- Acciaio AISI 304 satinato
- Dimensioni: **510 x 500** - 1 vasca: **462 x 400**
- Piletta SPACE 3 1/2"
- Sistema a 3 invasi

Accessori, disegno tecnico e pilette automatiche
a pag. 232



Configurazione
griglie Black
a filo vasca



Configurazione
griglie Black
su fondo vasca

- 

B9
Griglia Black
39,2 x 44,8 cm
8100 600

LIV. 1 - 3
- 

L4
Tagliere cristallo
23 x 41 cm
8631 300

LIV. 2
- 

K2
Kit tagliere
44,8 x 28,9 cm
8100 037

LIV. 1
- 

K3
Kit porta spezie
44,8 x 10 cm
8100 620

LIV. 1
- 

K4
Kit porta bottiglie
44,8 x 14 cm
8100 621

LIV. 1
- 

K5
Kit vaschette
44,8 x 18 cm
8100 622

LIV. 1
- 

K6
Kit vaschetta+owl
44,8 x 28 cm
8100 628

LIV. 1
- 

K7
Kit tagliere in legno
Iroko 42 x 31,7 cm
con vaschetta
scolapasta
in acciaio inox
8644 044
- 

K8 *
Kit grattugie
con anello supporto
e vaschetta raccogli
vivande
8159 101

- 

P6
Tagliere legno noce
18 x 44 cm
8642 000
- 

N3
Tagliere Twin
in HDPE
31,7 x 41,8 cm
8644 101

LIV. 2
- 

T2 *
Cestello portapiatti
Inox 21,4 x 37,9 cm
8100 303
- 

Z2 *
Vaschetta forata
Inox 21,5 x 38 cm
8151 000

Disponibile anche in versione PVD

- 
Gun Metal
8151 006
- 
Copper
8151 008
- 
Gold
8151 009

- 

X1 **
Vaschetta inox forata
12,6 x 12,1 cm
8151 001
- 

X3 ***
Porta coltelli
8100 030

1015 850 **B9 L4 K2 K3 K4 K5 K6 K7**
K8 P6 N3 T2 Z2 X1 X3

1016 850 **B9 L4 K2 K3 K4 K5 K6 K7**
K8 P6 N3 T2 Z2 X1 X3

1014 850 **B9 L4 K2 K3 K4 K5 K6 K7**
K8 P6 N3 T2 Z2 X1 X3

1013 850 **B9 L4 K2 K3 K4 K5 K6 K7**
K8 P6 N3 T2 Z2 X1 X3

pilette automatiche opzionali

1015 850 **PL PP PA PE PM PS**

1016 850 **PL PP PA PE PM PS**

1014 850 **PL PP PA PE PM PS**

1013 850 **PL PP PA PE PM PS**

Vedi pag. 298

* utilizzabile solo in abbinamento al tagliere N3
 ** utilizzabile solo in abbinamento al kit K2
 *** utilizzabile solo in abbinamento al kit K4

1015 850

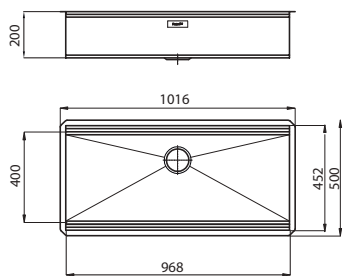

1016 850

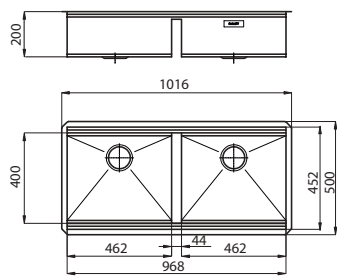

1014 850

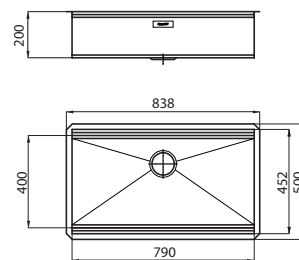

1013 850

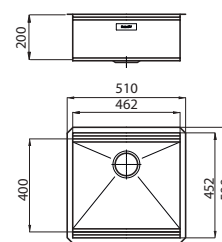

Schema di posizionamento degli accessori sugli invasi

Il sistema di "corsie" rende possibile l'utilizzo combinato di innumerevoli accessori. Griglie, taglieri, portautensili, vaschette e contenitori di varie dimensioni si alternano nella zona di lavoro con un semplice gesto e possono essere impilati, sempre a portata di mano.

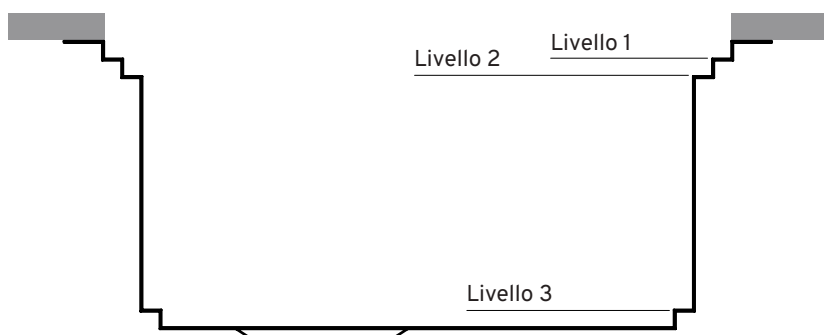

Quadra EVO **NEW**
sottotop

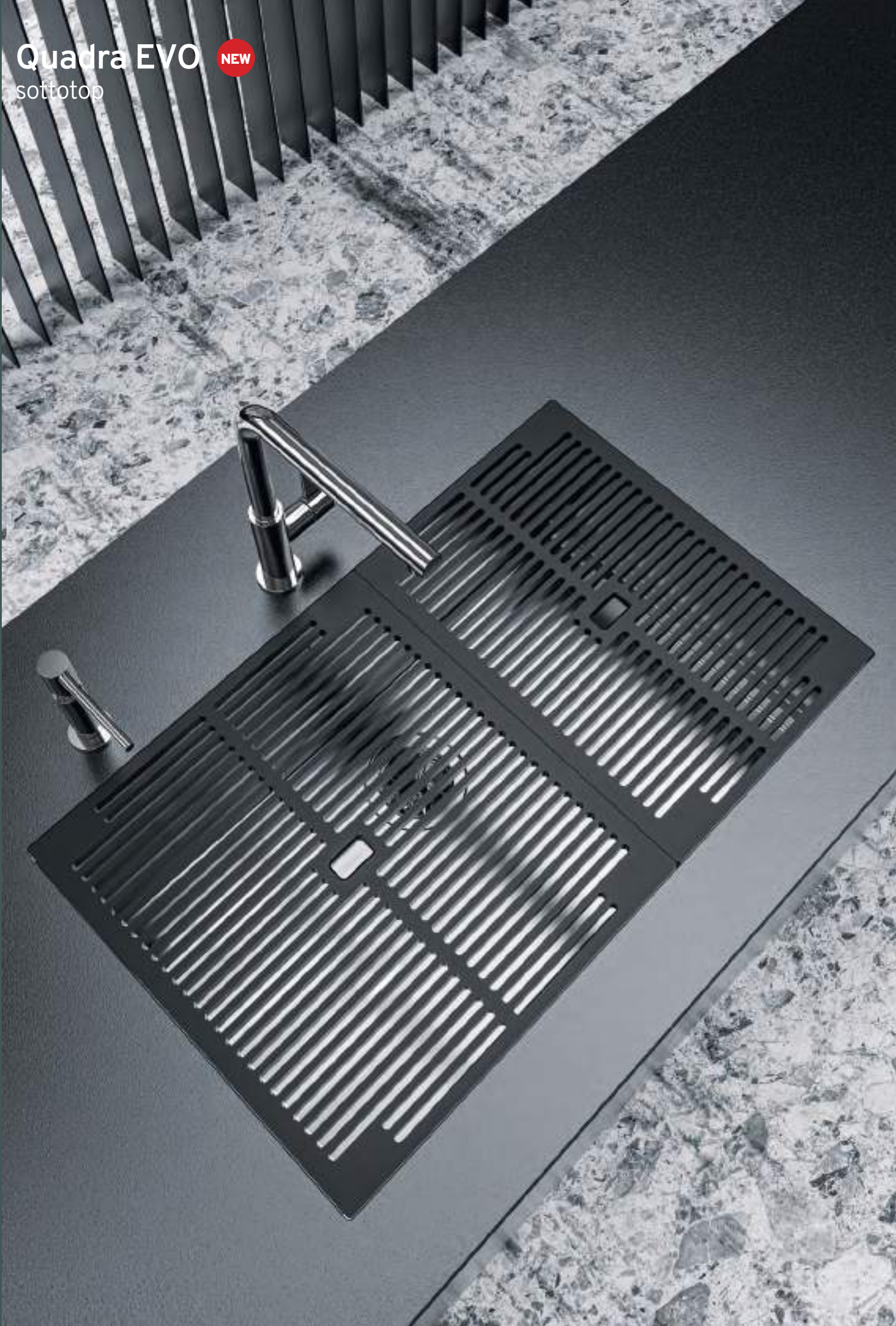



Nell'installazione positive reveal

il gradino di 12 mm permette alla griglia di avere un effetto di continuità con il top.



Possibilità di griglie personalizzate

Possibilità di fornire su richiesta le geometrie Cad 3D per realizzare griglie dello stesso materiale del top.

LAVELLI
SOTTOTOP

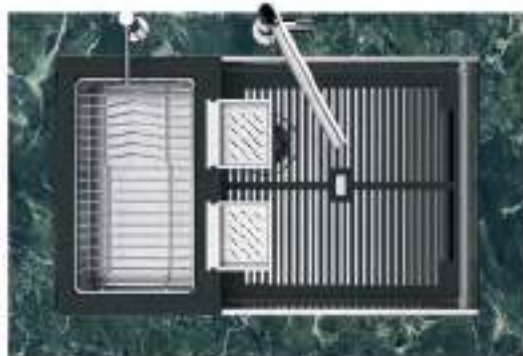

Quadra EVO

sottotop



Codice

Versione

Caratteristiche

Prezzo

Base 90

1257 850



ST

incasso: 740 x 452 R5



- Acciaio AISI 304 satinato
- Dimensioni: **780 x 470** - 1 vasca: **740 x 430**
- Piletta 3,5"

- Disponibile anche in versione **PVD**

Gun Metal
1257 856



pag. 26

In dotazione: **2 griglie** (8100 614 - 8100 615)
Accessori, disegno tecnico
e pilette automatiche a pag. 238



Configurazione
griglie Black
a filo vasca



Configurazione
griglie Black
su fondo vasca

Base 80

1255 850



ST

incasso: 530 x 452 R5



- Acciaio AISI 304 satinato
- Dimensioni: **570 x 470** - 1 vasca: **530 x 430**
- Piletta 3,5"

- Disponibile anche in versione **PVD**

Gun Metal
1255 856



pag. 27

In dotazione: **1 griglia** (8100 615)
Accessori, disegno tecnico
e pilette automatiche a pag. 238



Configurazione
griglie Black
a filo vasca



Configurazione
griglie Black
su fondo vasca

Base 60

1254 850



ST

incasso: 430 x 452 R5



- Acciaio AISI 304 satinato
- Dimensioni: **470 x 470** - 1 vasca: **430 x 430**
- Piletta 3,5"

- Disponibile anche in versione **PVD**

Gun Metal
1254 856



pag. 27

In dotazione: **1 griglia** (8100 615)
Accessori, disegno tecnico
e pilette automatiche a pag. 238



Configurazione
griglie Black
a filo vasca

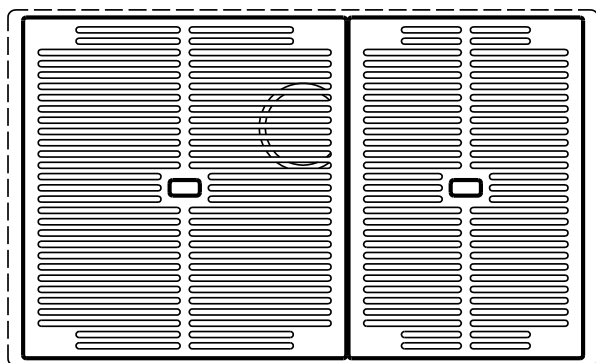

Configurazione **griglie Black 8100 615 + 8100 614**
a filo vasca

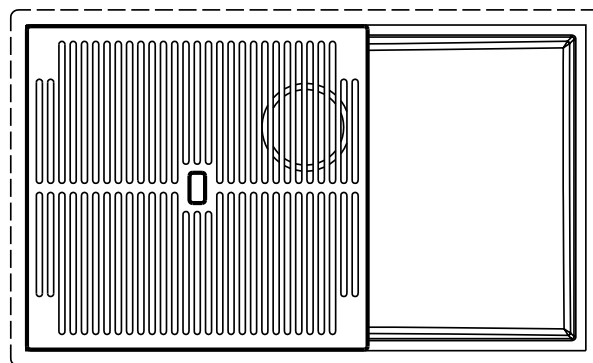

Configurazione **griglia Black 8100 615**
in appoggio al gradino perimetrale sul fondo

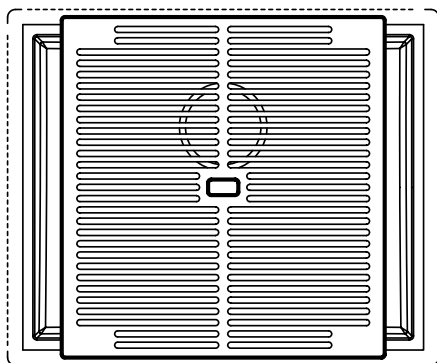

Configurazione **griglia Black 8100 615**
a filo vasca

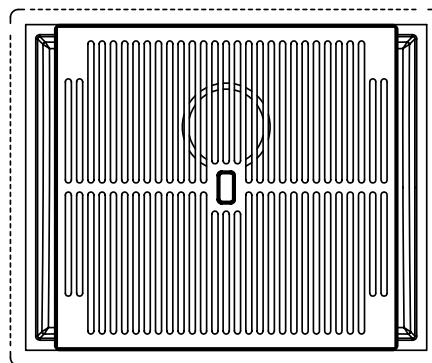

Configurazione **griglia Black 8100 615**
in appoggio al gradino perimetrale sul fondo

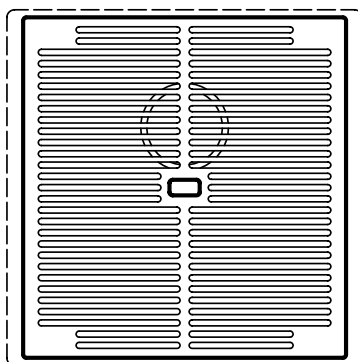

Configurazione **griglia Black 8100 615**
a filo vasca



K2

Kit tagliere
44,8 x 28,9 cm
8100 037

LIV. 1



K3

Kit porta spezie
44,8 x 10 cm
8100 620

LIV. 1



K4

Kit porta bottiglie
44,8 x 14 cm
8100 621

LIV. 1



K5

Kit vaschette
44,8 x 18 cm
8100 622

LIV. 1



K6

Kit vaschetta
44,8 x 28 cm
8100 628

LIV. 1



O2

Vaschetta bianca
41,4x27,2 cm
8153 100

Sul fondo



P6

Tagliere
in legno noce
18x44,8 cm
8642 000

LIV. 1



T2 *

Cestello
portapiatti inox
21,4x37,9 cm
8100 303



X1 *

Vaschetta inox forata
12,6 x 12,1 cm
8151 001



Z2 *

Vaschetta forata inox
21,5x38 cm
8151 000

Disponibile anche in versione **PVD**



Gun Metal
8151 006



Copper
8151 008



Gold
8151 009



B1

Griglia Black
42,7 x 45 cm
8100 615

LIV. 1 / LIV. 2
in dotazione



B2

Griglia Black
31 x 45 cm
8100 614

LIV. 1
in dotazione



X3 **

Porta coltelli
8100 030



K8 *

Kit grattugie con
anello-supporto e
vaschetta vivande
8159 101

1257 850 **K2** **K3** **K4** **K5** **K6** **O2** **P6** **T2**
X1 **B1** **B2** **Z2** **X3** **K8**

1255 850 **K2** **K3** **K4** **K5** **K6** **O2** **P6** **T2**
X1 **B1** **Z2** **X3** **K8**

1254 850 **K2** **K3** **K4** **K5** **K6** **O2** **P6** **T2**
X1 **B1** **Z2** **X3** **K8**

pilette automatiche opzionali

1257 850 **PL** **PP** **PM** **PA**

1255 850 **PL** **PP** **PM** **PA**

1254 850 **PL** **PP** **PM** **PA**

Vedi pag. 298

* utilizzabile solo in abbinamento al kit K2
** utilizzabile solo in abbinamento al kit K4

1257 850

1255 850

1254 850

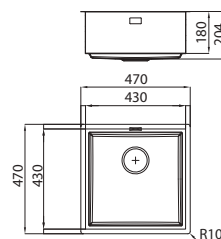
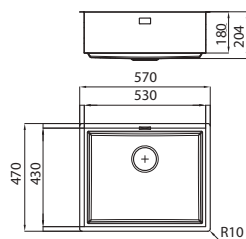
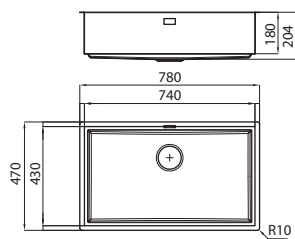

LAVELLI
SOTTOTOP

Schema di posizionamento degli accessori sugli invasi

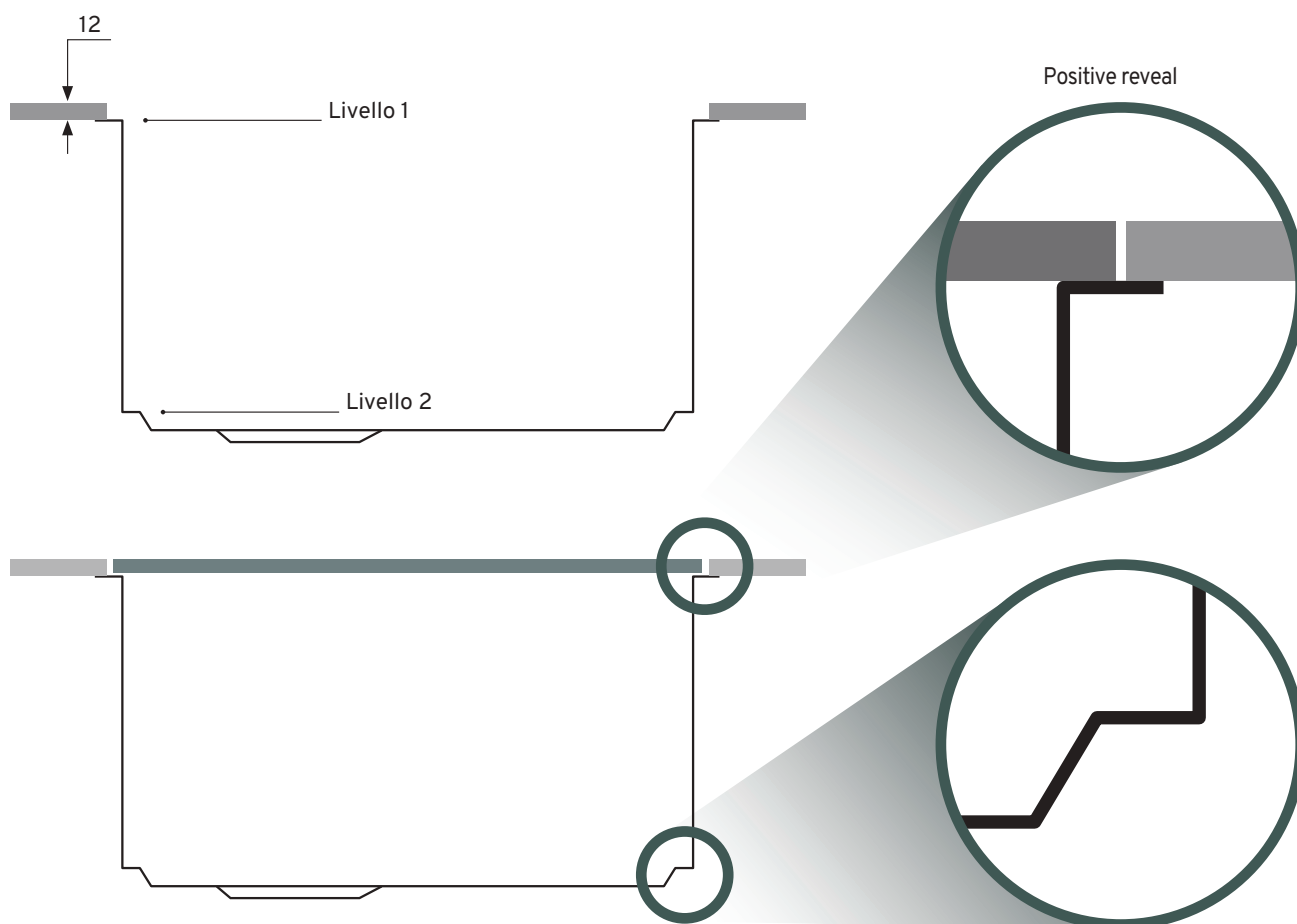

Possibilità di abbinamento delle griglie a filo utilizzando top da 12 mm

Quadra R12
sottotop

NEW





Lavelli con vasche R12



Il fondo è diamantato



In dotazione c'è una griglia Black

che può essere posta sia in appoggio sul piano, sia in appoggio sul fondo grazie a quattro piedini in gomma.



Quadra R12

sottotop



Codice | Versione | Caratteristiche | Prezzo

Base 90

1718 850 ST incasso: 800 x 400 R12



- Acciaio AISI 304 satinato
- Dimensioni: **840 x 440** - 1 vasca: **800 x 400**
- Piletta 3,5"

In dotazione: **1 griglia** (8100 617)
Accessori, disegno tecnico
e pilette automatiche a pag. 244



Configurazione
griglie Black
a filo vasca



Configurazione
griglie Black
su fondo vasca

Base 80

1717 850 ST incasso: 710 x 400 R12



- Acciaio AISI 304 satinato
- Dimensioni: **750 x 440** - 1 vasca: **710 x 400**
- Piletta 3,5"

• Disponibile anche
in versione **PVD**

Gun Metal

1717 856



pag. 28

**Gun Metal
Fumé**

1717 816



pag. 28

Brandy

1717 855



pag. 83

**Brandy
Fumé**

1717 815



pag. 83

In dotazione: **1 griglia** (8100 617)
Accessori, disegno tecnico
e pilette automatiche a pag. 244

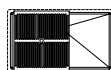

Configurazione
griglie Black
a filo vasca

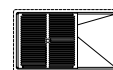

Configurazione
griglie Black
su fondo vasca

Base 60

1715 850 ST incasso: 500 x 400 R12



- Acciaio AISI 304 satinato
- Dimensioni: **540 x 440** - 1 vasca: **500 x 400**
- Piletta 3,5"

• Disponibile anche
in versione **PVD**

Gun Metal

1715 856



pag. 29

**Gun Metal
Fumé**

1715 816



pag. 29

Brandy

1715 855



pag. 83

**Brandy
Fumé**

1715 815



pag. 83

In dotazione: **1 griglia** (8100 617)
Accessori, disegno tecnico
e pilette automatiche a pag. 244



Configurazione
griglie Black
a filo vasca



Configurazione
griglie Black
su fondo vasca

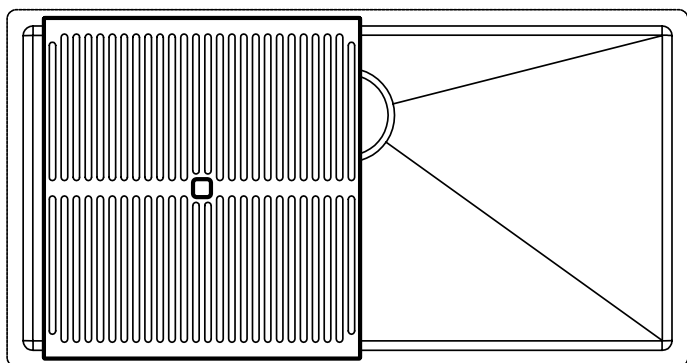

Configurazione **griglia Black 8100 617**
in appoggio sul top

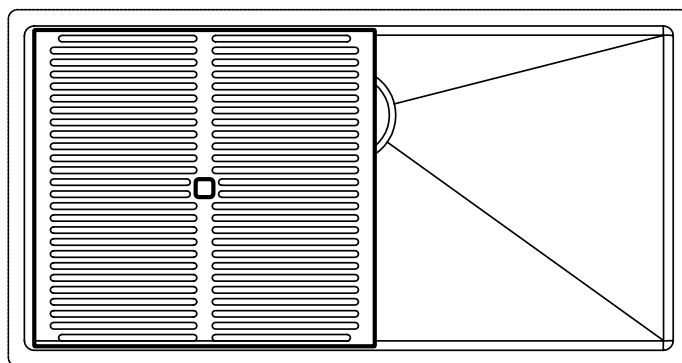

Configurazione **griglia Black 8100 617**
in appoggio sul fondo

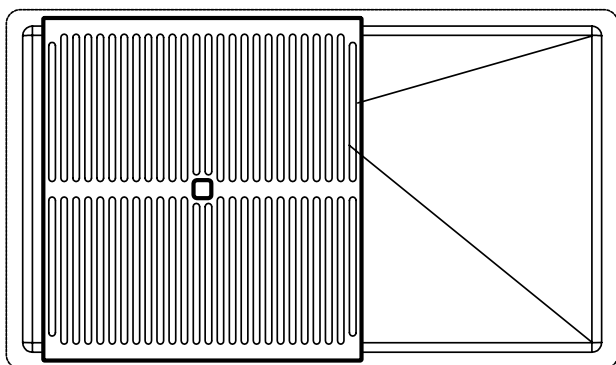

Configurazione **griglia Black 8100 617**
in appoggio sul top

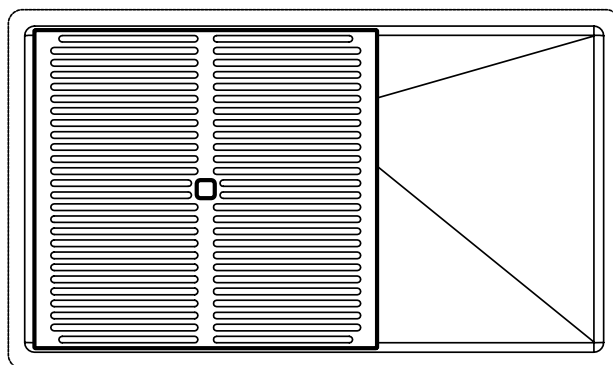

Configurazione **griglia Black 8100 617**
in appoggio sul fondo

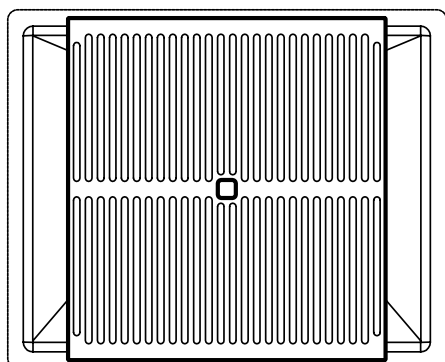

Configurazione **griglia Black 8100 617**
in appoggio sul top

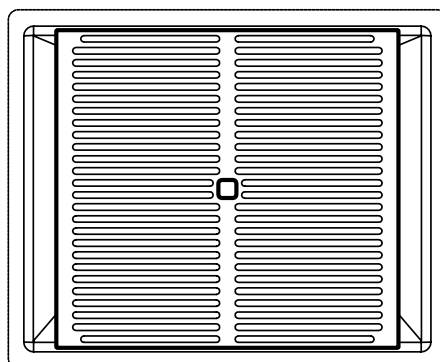

Configurazione **griglia Black 8100 617**
in appoggio sul fondo



B3

Griglia Black
39 x 42 cm
8100 617

in dotazione



K7

Kit tagliere in legno
Iroko 42 x 31,7 cm
con vaschetta
scolapasta
in acciaio inox
8644 044



K8 *

Kit grattugie
con anello-supporto
e vaschetta raccogli
vivande
8159 101



L4

Tagliere in cristallo
23x41 cm
8631 300



N2

Tagliere
in HDPE
27,2x42,5 cm
8657 001



N3

Tagliere Twin in HDPE
31,7x41,8 cm
8644 101



O2

Vaschetta bianca
41,4x27,2 cm
8153 100



R2

Cestello inox
34x40 cm
8611 000



T1

Cestello
portapiatti inox
25x42,5 cm
8100 201



T2 *

Cestello
portapiatti inox
21,4x37,9 cm
8100 303



Z2 *

Vaschetta forata inox
21,5x38 cm
8151 000

Disponibile anche in versione **PVD**



Gun Metal
8151 006



Copper
8151 008



Gold
8151 009

1718 850 **B3 K7 K8 L4 N2 N3 O2 R2**
T1 T2 Z2

1717 850 **B3 K7 K8 L4 N2 N3 O2 R2**
T1 T2 Z2

1715 850 **B3 K7 K8 L4 N2 N3 O2 R2**
T1 T2 Z2

pilette automatiche opzionali

1718 850 **PL PP PA PE PM**

1717 850 **PL PP PA PE PM**

1715 850 **PL PP PA PE PM**

Vedi pag. 298

* utilizzabile solo in abbinamento al tagliere N3

1718 850

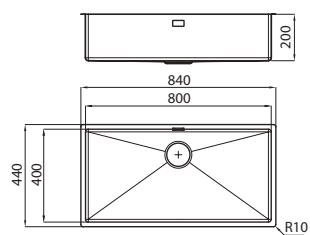

1717 850

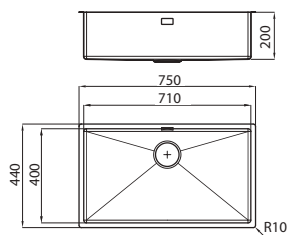

1715 850

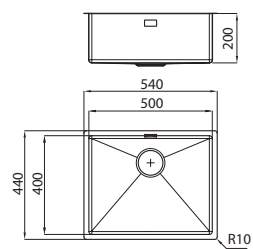

Quadra
sottotop



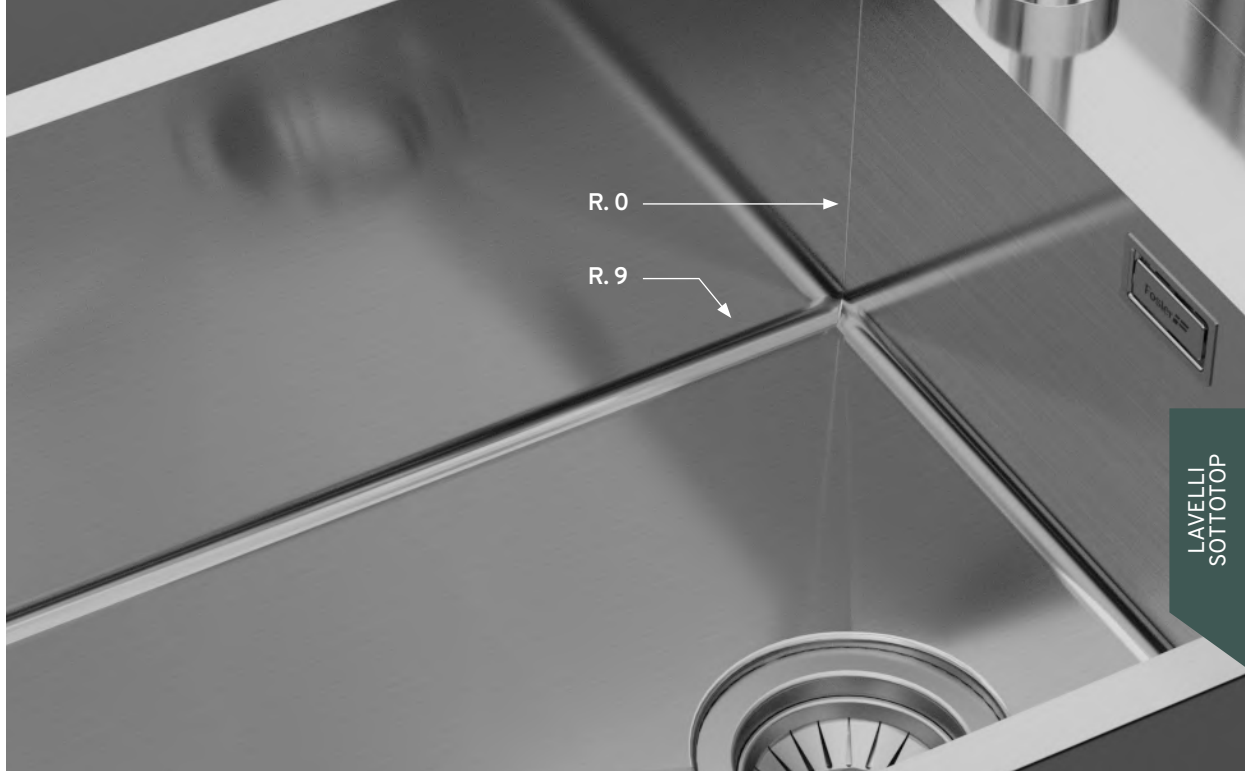

LAVELLI
SOTTOTOP

Il raggio R9 sul fondo
facilita le operazioni di pulizia

Quadra

sottotop

Codice

Versione

Caratteristiche

Prezzo

Base 90

1218 850

ST

incasso: 800 x 400



- Acciaio AISI 304 satinato
- Dimensioni: **850 x 450** - 1 vasca: **800 x 400**
- Piletta 3/2"

Accessori, disegno tecnico
e pilette automatiche a pag. 250

Base 80

1217 850

ST

incasso: 710 x 400



- Acciaio AISI 304 satinato
- Dimensioni: **760 x 450** - 1 vasca: **710 x 400**
- Piletta 3/2"

Accessori, disegno tecnico
e pilette automatiche a pag. 250

Base 60

1215 850

ST

incasso: 500 x 400



- Acciaio AISI 304 satinato
- Dimensioni: **550 x 450** - 1 vasca: **500 x 400**
- Piletta 3/2"

Accessori, disegno tecnico
e pilette automatiche a pag. 250

Quadra sottotop

Codice

Versione

Caratteristiche

Prezzo

■ Base 60

1214 850

ST

incasso: 400 x 400



- Acciaio AISI 304 satinato
- Dimensioni: **450 x 450** - 1 vasca: **400 x 400**
- Piletta 3½"

Accessori, disegno tecnico
e pilette automatiche a pag. 250

LAVELLI
SOTTOTOP

■ Base 90

NEW

1221 850

ST

incasso: 800 x 400



- Acciaio AISI 304 satinato
- Dimensioni: **840 x 440** - 2 vasche: **380 x 400**
- Piletta 3,5"

Accessori, disegno tecnico
e pilette automatiche a pag. 250

Quadra

accessori



B3

Griglia Black
39 x 42 cm
8100 617



K7

Kit tagliere in legno
Iroko 42 x 31,7 cm
con vaschetta
scolapasta
in acciaio inox
8644 044



K8 *

Kit grattugie con
anello-supporto e
vaschetta vivande
8159 101

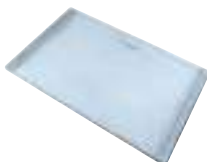

L4

Tagliere cristallo
23x41 cm
8631 300



N2

Tagliere in HDPE
27,2x42,5 cm
8657 001



N3

Tagliere Twin
in HDPE 31,7x41,8
8644 101



O2

Vaschetta bianca
27,2x41,4 cm
8153 100



R2

Cestello Inox
34x40 cm
8611 000



R3

Cestello Inox
40x40
8612 000



T1

Cestello portapiatti
inox 25x42,5 cm
8100 201

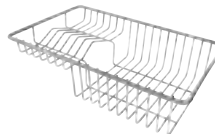

T2 *

Cestello portapiatti
inox 21,4x37,9 cm
8100 303



Z2 *

Vaschetta forata
inox 21,5x38 cm
8151 000

Disponibile anche in versione PVD



Gun Metal
8151 006



Copper
8151 008



Gold
8151 009

1218 850 **B3 K7 K8 L4 N2 N3 O2 R2**
R3 T1 T2 Z2

1217 850 **B3 K7 K8 L4 N2 N3 O2 R2**
R3 T1 T2 Z2

1215 850 **B3 K7 K8 L4 N2 N3 O2 R2**
R3 T1 T2 Z2

1214 850 **K7 K8 L4 N2 N3 O2 R2 R3**
T1 T2 Z2

1221 850 **K7 K8 L4 N2 N3 O2 R2 R3**
T1 T2 Z2

pilette automatiche opzionali

1218 850 **PL PP PA PM**

1217 850 **PL PP PA PM**

1215 850 **PL PP PA PM**

1214 850 **PL PP PA PM**

1221 850 **PL PP PA PM**

Vedi pag. 298

* utilizzabile solo in abbinamento al tagliere N3

1218 850

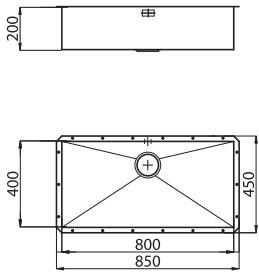

1217 850

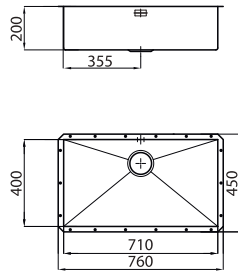

1215 850

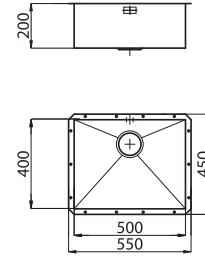

1214 850

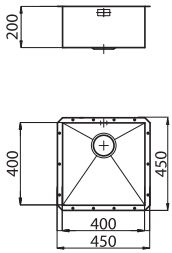

1221 850 **NEW**

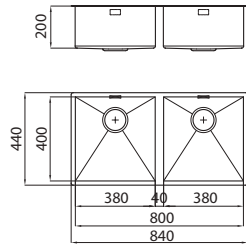

Circolari NEW

sottotop

Lavello
di spessore

Lucidatura
concentrica
di grande effetto



Base 60



Codice	Versione	Caratteristiche	Prezzo
--------	----------	-----------------	--------

1130 860

ST

incasso: Ø 380

- Acciaio AISI 304 satinato
- Dimensioni: Ø 425 - 1 vasca: Ø 380
- Piletta 3½"

• Disponibile anche
in versione PVD

Gun Metal
1130 866



pag. 29

Copper
1130 868



pag. 52

Gold
1130 869



pag. 70

accessori



P1

Tagliere
41,4 x 32 cm
in legno Iroko
8648 002

pilette automatiche opzionali

PR PQ PC

Vedi pag. 298

disegno tecnico

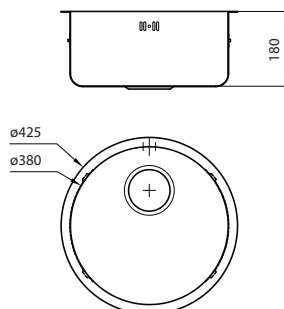



LAVELLI
SOTTOTOP

S4001 | vasche sottotop R12



S4001 | vasche sottotop R12

Codice

Versione

Caratteristiche

Prezzo

Base 90

3358 850

ST

incasso: 800 x 400 R12



- Acciaio AISI 304 satinato
- Dimensioni: **840 x 440** - 1 vasca: **800 x 400**
- Piletta Space 3½"

Accessori, disegno tecnico
e pilette automatiche a pag. 258

Base 80

3357 850

ST

incasso: 710 x 400 R12



- Acciaio AISI 304 satinato
- Dimensioni: **750 x 440** - 1 vasca: **710 x 400**
- Piletta Space 3½"

Accessori, disegno tecnico
e pilette automatiche a pag. 258

Base 80

3352 850

ST

incasso: 710 x 400 R12



- Acciaio AISI 304 satinato
- Dimensioni: **750 x 440** - 2 vasche: **340 x 400**
- Piletta Space 3½"

Accessori, disegno tecnico
e pilette automatiche a pag. 258

| Base 60

3355 850

ST

incasso: 500 x 400 R12



- Acciaio AISI 304 satinato
- Dimensioni: **540 x 440** - 1 vasca: **500 x 400**
- Piletta Space 3½"

Accessori, disegno tecnico
e pilette automatiche a pag. 258

| Base 60

3356 850

ST

incasso: 400 x 400 R12



- Acciaio AISI 304 satinato
- Dimensioni: **440 x 440** - 1 vasca: **400 x 400**
- Piletta Space 3½"

Accessori, disegno tecnico
e pilette automatiche a pag. 258

| Base 45

3353 850

ST

incasso: 340 x 400 R12



- Acciaio AISI 304 satinato
- Dimensioni: **380 x 440** - 1 vasca: **340 x 400**
- Piletta Space 3½"

Accessori, disegno tecnico
e pilette automatiche a pag. 258

S4001 | vasche sottotop R12

Codice

Versione

Caratteristiche

Prezzo

Base 75

NEW

3138 850

ST

incasso: 665 x 375 R12



- Acciaio AISI 304 satinato
- Dimensioni: **695 x 405** - 1 vasca: **665 x 375**
- Piletta Space 3½"

Accessori, disegno tecnico
e pilette automatiche a pag. 258

Per un perfetto abbinamento vedi gli altri prodotti per basi e moduli da 75 a
pagina 449

LAVELLI
SOTTOTOP

S4001 | vasche sottotop

accessori

B3



Griglia Black
39 x 42 cm
8100 617

B6



Griglia Black
38 x 38 cm
8100 651

B7



Griglia Black
38 x 48 cm
8100 652

B8



Griglia Black
38 x 69 cm
8100 653

K7



Kit tagliere in legno
Iroko 42 x 31,7 cm
con vaschetta
scolapasta
in acciaio inox
8644 044

L4



Tagliere cristallo
23x41 cm
8631 300

N2



Tagliere in HDPE
27,2x42,5 cm
8657 001

N3



Tagliere Twin
in HDPE 31,7x41,8
8644 101

O2



Vaschetta bianca
27,2x41,4 cm
8153 100



K8 *

Kit grattugie con
anello-supporto e
vaschetta vivande
8159 101

R2



Cestello Inox
34x40 cm
8611 000

R3



Cestello Inox
40x40
8612 000

T1



Cestello portapiatti
inox 25x42,5 cm
8100 201

T2 *

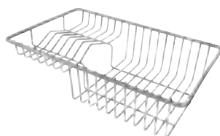

Cestello portapiatti
inox 21,4x37,9 cm
8100 303

T8



Griglia
portapiatti inox
21,4x37,2 cm
8100 306

Z2 *



Vaschetta forata
inox 21,5x38 cm
8151 000

Disponibile anche in versione **PVD**



Gun Metal
8151 006



Copper
8151 008



Gold
8151 009

Z3



Vaschetta
forata inox
21,5x40 cm
8156 000

P2



Tagliere
39,5 x 22,5 cm
in legno Iroko
8642 004

* utilizzabile solo in abbinamento al tagliere N3

3358 850 **B3 K7 L4 N2 N3 O2 K8 R2**
R3 T1 T2 Z2

3357 850 **K7 L4 N2 N3 O2 K8 R2 R3**
T1 T2 Z2

3352 850 **K7 L4 N2 N3 O2 K8 R2 R3**
T1 T2 Z2

3355 850 **B3 B7 K7 L4 N2 N3 O2 K8**
R2 R3 T1 T2 Z2

3356 850 **B3 K7 L4 N2 N3 O2 K8 R2**
R3 T1 T2 Z2

3353 850 **K7 L4 N2 N3 O2 K8 R2 R3**
T1 T2 Z2

3138 850 **Z3 O2 R2 T8 P2**

pilette automatiche opzionali

3138 850 **PL PP PA PE PM**

3358 850 **PL PP PA PE PM**

3357 850 **PL PP PA PE PM**

3352 850 **PL PP PA PE PM**

3355 850 **PL PP PA PE PM**

3356 850 **PL PP PA PE PM**

3353 850 **PL PP PA PE PM**

Vedi pag. 298

S4001 | vasche sottotop | disegni tecnici

3358 850

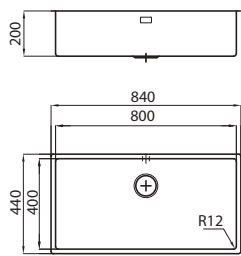

3357 850

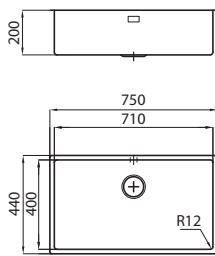

3352 850

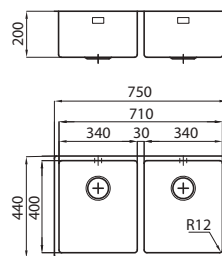

3355 850

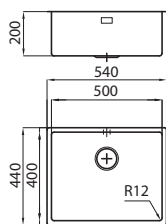

3356 850

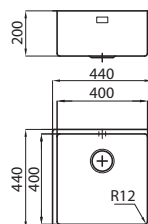

3353 850

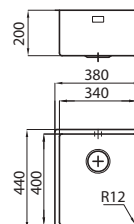

3138 850

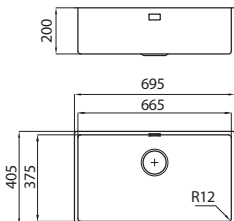

LAVELLI
SOTTOTOP

Base 90**3143 850** **ST**

incasso: 800 x 450 R12



45 cm

- Acciaio AISI 304 satinato
- Dimensioni: **830 x 480** - 1 vasca: **800 x 450**
- Piletta 3½"

Accessori, disegno tecnico e pilette automatiche
a pag. 261

Base 60**3141 850** **ST**

incasso: 500 x 450 R12



45 cm

- Acciaio AISI 304 satinato
- Dimensioni: **530 x 480** - 1 vasca: **500 x 450**
- Piletta 3½"

Accessori, disegno tecnico e pilette automatiche
a pag. 261

Base 60**3139 850** **ST**

incasso: 400 x 450 R12



45 cm

- Acciaio AISI 304 satinato
- Dimensioni: **430 x 480** - 1 vasca: **400 x 450**
- Piletta 3½"

Accessori, disegno tecnico e pilette automatiche
a pag. 261

Serie 45 | accessori



K1
Kit cornice supporto
28x47,4
multiaccessori con
tagliere HDPE
8100 627



O2
Vaschetta bianca
27,2x41,4 cm
8153 100



K8 *
Kit grattugie con
anello-supporto e
vaschetta vivande
8159 101



R3
Cestello Inox
40x40 - 8612 000



T2 *
Cestello portapiatti
inox 21,4x37,9 cm
8100 303



Z2 *
Vaschetta forata
inox 21,5x38 cm
8151 000

Disponibile anche in versione PVD



Gun Metal
8151 006



Copper
8151 008



Gold
8151 009

* utilizzabile solo in abbinamento al kit K1

3143 850 **K1 O2 K8 R3 T2 Z2**

3141 850 **K1 O2 K8 R3 T2 Z2**

3139 850 **K1 O2 K8 R3 T2 Z2**

pilette automatiche opzionali

3143 850 **PA PE PM PL PP**

3141 850 **PA PE PM PL PP**

3139 850 **PA PE PM PL PP**

Vedi pag. 298

LAVELLI
SOTTOTOP

Serie 45 | disegni tecnici

3143 850

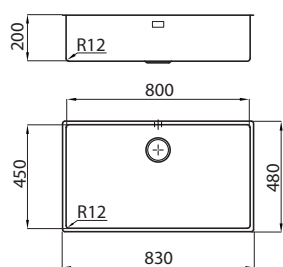

3141 850

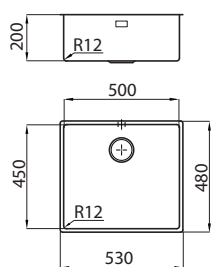

3139 850

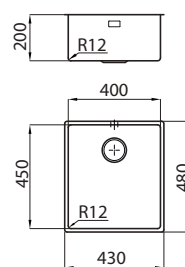

Base 90**3137 850** **ST**

incasso: 750 x 350 R12



35 cm

- Acciaio AISI 304 satinato
- Dimensioni: **780 x 380** - 1 vasca: **750 x 350**
- Piletta 3½"

Accessori, disegno tecnico e pilette a pag. 263

Base 60**3135 850** **ST**

incasso: 500 x 350 R12



35 cm

- Acciaio AISI 304 satinato
- Dimensioni: **530 x 380** - 1 vasca: **500 x 350**
- Piletta 3½"

Accessori, disegno tecnico e pilette a pag. 263

Base 45**3136 850** **ST**

incasso: 365 x 350 R12



35 cm

- Acciaio AISI 304 satinato
- Dimensioni: **395 x 380** - 1 vasca: **365 x 350**
- Piletta 3½"

Accessori, disegno tecnico e pilette a pag. 263

Serie 35 | accessori



P3

Tagliere
26x36,6 cm
8643 117



T6

Griglia portapiatti
inox 23x37,5 cm
8100 305



O2

Vaschetta bianca
27,2x41,4 cm
8153 100



B4

Griglia Black
36,8 x 34,2 cm
8100 618

3137 850 **P3 T6 O2 B4**

3135 850 **P3 T6 O2 B4**

3136 850 **P3 T6 O2**

pilette automatiche opzionali

3137 850 **PA PE PM PL PP**

3135 850 **PA PE PM PL PP**

3136 850 **PA PE PM PL PP**

Vedi pag. 298

LAVELLI
SOTTOTOP

Serie 35 | disegni tecnici

3137 850

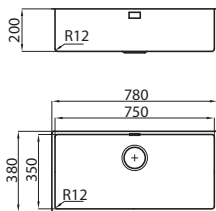

3135 850

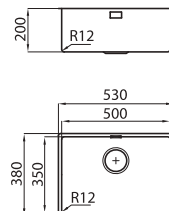

3136 850

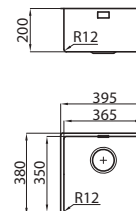

KE | R15
sottotop



KE | R15

sottotop

Codice

Versione

Caratteristiche

Prezzo

Base 100

2207 850

ST

incasso: 880 x 400 R15



- Acciaio AISI 304 satinato
- Dimensioni: **930 x 450** - 2 vasche: **450 x 400 + 400 x 400**
- Piletta 3/2"

Accessori, disegno tecnico
e pilette automatiche a pag. 270

Base 90

2206 850

ST

incasso: 770 x 400 R15



- Acciaio AISI 304 satinato
- Dimensioni: **820 x 450** - 2 vasche: **400 x 400 + 340 x 400**
 - Piletta 3/2"

Accessori, disegno tecnico
e pilette automatiche a pag. 270

Base 90

2205 850

ST

incasso: 750 x 400 R15



- Acciaio AISI 304 satinato
- Dimensioni: **800 x 450** - 2 vasche: **450 x 400 + 270 x 400**
- Piletta 3/2"

Accessori, disegno tecnico
e pilette automatiche a pag. 270

KE | R15

sottotop

Codice

Versione

Caratteristiche

Prezzo

Base 80

2204 851 dx  ST
2204 852 sx

incasso: 710 x 400 R15



- Acciaio AISI 304 satinato
- Dimensioni: **760 x 450** - 2 vasche: **500 x 400 + 180 x 400**
- Piletta 3½"

Accessori, disegno tecnico
e pilette automatiche a pag. 270

Base 80

2203 850  ST

incasso: 710 x 400 R15



- Acciaio AISI 304 satinato
- Dimensioni: **760 x 450** - 2 vasche: **340 x 400**
- Piletta 3½"

Accessori, disegno tecnico
e pilette automatiche a pag. 270

Base 80

2202 851 dx  ST
2202 852 sx

incasso: 610 x 400 R15



- Acciaio AISI 304 satinato
- Dimensioni: **660 x 450** - 2 vasche: **400 x 400 + 180 x 400**
- Piletta 3½"

Accessori, disegno tecnico
e pilette automatiche a pag. 270

KE | R15

sottotop

Codice | Versione | Caratteristiche | Prezzo

Base 80

2201 851 dx  ST incasso: 545 x 400 R15
2201 852 sx



- Acciaio AISI 304 satinato
- Dimensioni: **585 x 440** - 2 vasche: **340 x 400 + 180 x 400**
- Piletta 3½"

Accessori, disegno tecnico e pilette automatiche a pag. 270





LAVELLI SOTTOTOP

Base 80

2157 850  ST incasso: 710 x 400 R15



- Acciaio AISI 304 satinato
- Dimensioni: **750 x 440** - 1 vasca: **710 x 400**
- Piletta 3½"
- Disponibile anche in versione **Vintage, PVD e PVD Vintage**

Vintage inox 2157 880	Gun Metal 2157 856	Copper 2157 858	Gold 2157 859	Brandy 2157 855
				
	Vintage 2157 886	Vintage 2157 888	Vintage 2157 889	
	pag. 30	pag. 50	pag. 68	pag. 85 NEW





Accessori, disegno tecnico e pilette automatiche a pag. 270

Base 60

2155 850  ST incasso: 500 x 400 R15



- Acciaio AISI 304 satinato
- Dimensioni: **540 x 440** - 1 vasca: **500 x 400**
- Piletta 3½"
- Disponibile anche in versione **Vintage, PVD e PVD Vintage**

Vintage inox 2155 880	Gun Metal 2155 856	Copper 2155 858	Gold 2155 859	Brandy 2155 855
				
	Vintage 2155 886	Vintage 2155 888	Vintage 2155 889	
	pag. 31	pag. 51	pag. 69	pag. 85 NEW

Accessori, disegno tecnico e pilette automatiche a pag. 270

KE R15

sottotop

Codice

Versione

Caratteristiche

Prezzo

Base 60

2154 850

ST

incasso: 450 x 400 R15



Accessori, disegno tecnico
e pilette automatiche a pag. 270

- Acciaio AISI 304 satinato
- Dimensioni: **490 x 440** - 1 vasca: **450 x 400**
- Piletta 3½"

- Disponibile anche
in versione **PVD**

Gun Metal
2154 856



pag. 31

Base 60

2156 850

ST

incasso: 400 x 400 R15



Accessori, disegno tecnico
e pilette automatiche a pag. 270

- Acciaio AISI 304 satinato
- Dimensioni: **440 x 440** - 1 vasca: **400 x 400**
- Piletta 3½"

- Disponibile anche in versione **Vintage, PVD e PVD Vintage**

Vintage
inox
2156 880



Gun Metal
2156 856

Vintage
2156 886



pag. 32

Copper
2156 858

Vintage
2156 888



pag. 51

Gold
2156 859

Vintage
2156 889



pag. 69

Base 45

2153 850

ST

incasso: 340 x 400 R15



Accessori, disegno tecnico
e pilette automatiche a pag. 270

- Acciaio AISI 304 satinato
- Dimensioni: **380 x 440** - 1 vasca: **340 x 400**
- Piletta 3½"

- Disponibile anche
in versione **PVD**

Gun Metal
2153 856



pag. 32

KE | R15

sottotop

Codice

Versione

Caratteristiche

Prezzo

Base 40

2152 850

ST

incasso: 270 x 400 R15



- Acciaio AISI 304 satinato
- Dimensioni: **310 x 440** - 1 vasca: **270 x 400**
- Piletta 3½"

Accessori, disegno tecnico
e pilette automatiche a pag. 270

LAVELLI
SOTTOTOP

Base 30

2151 850

ST

incasso: 180 x 400 R15



- Acciaio AISI 304 satinato
- Dimensioni: **222 x 442** - 1 vasca: **180 x 400**
- Piletta 3½"

- Disponibile anche
in versione **PVD**

Gun Metal
2151 856



pag. 33

Accessori, disegno tecnico
e pilette automatiche a pag. 270

B3

Griglia Black
39 x 42 cm
8100 617



B6

Griglia Black
38 x 38 cm
8100 651



B7

Griglia Black
38 x 48 cm
8100 652



B8

Griglia Black
38 x 69 cm
8100 653



L4

Tagliere cristallo
23x41 cm
8631 300



N2

Tagliere in HDPE
27,2x42,5 cm
8657 001



N3

Tagliere Twin
in HDPE 31,7x41,8
8644 101



O2

Vaschetta bianca
27,2x41,4 cm
8153 100



K7

Kit tagliere in legno
Iroko 42 x 31,7 cm
con vaschetta
scolapasta
in acciaio inox
8644 044



K8 *

Kit grattugie con
anello-supporto e
vaschetta vivande
8159 101



R2

Cestello Inox
34x40 cm
8611 000



R3

Cestello Inox
40x40
8612 000



T1

Cestello portapiatti
inox 25x42,5 cm
8100 201

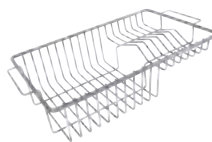

T2 *

Cestello portapiatti
inox 21,4x37,9 cm
8100 303

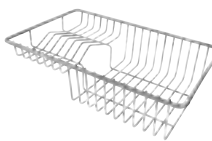

Z2 *

Vaschetta forata
inox 21,5x38 cm
8151 000



Disponibile anche in versione PVD



Gun Metal
8151 006



Copper
8151 008



Gold
8151 009

2207 850 **B3 L4 N2 N3 O2 K7 K8 R2**
R3 T1 T2 Z2 B6

2206 850 **B3 L4 N2 N3 O2 K7 K8 R2**
R3 T1 T2 Z2 B6

2205 850 **L4 N2 N3 O2 K7 K8 R2 R3**
T1 T2 Z2 B3

2204 851 **B3 L4 N2 N3 O2 K7 K8 R2**
2204 852 **R3 T1 T2 Z2 B7**

2203 850 **L4 N2 N3 O2 K7 K8 R2 R3**
T1 T2 Z2

2202 851 **L4 N2 N3 O2 K7 K8 R2 R3**
2202 852 **T1 T2 Z2 B3 B6**

2201 851 **L4 N2 N3 O2 K7 K8 R2 R3**
2201 852 **T1 T2 Z2**

2157 850 **B3 B8 L4 N2 N3 O2 K7 K8**
R2 R3 T1 T2 Z2

2155 850 **B3 B7 L4 N2 N3 O2 K7 K8**
R2 R3 T1 T2 Z2

2154 850 **B3 L4 N2 N3 O2 K7 K8 R2**
R3 T1 T2 Z2

2156 850 **B3 L4 N2 N3 O2 K7 K8 R2**
R3 T1 T2 Z2 B6

2153 850 **L4 N2 N3 O2 K7 K8 R2 R3**
T1 T2 Z2

2152 850 **L4 N2 T1**

pilette automatiche opzionali

su tutti i modelli della linea

PA PE PM PL PP

Vedi pag. 298

* utilizzabile solo in abbinamento al tagliere N3

2207 850

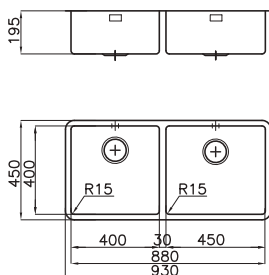

2206 850

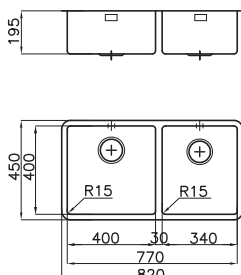

2205 850

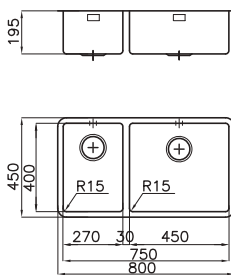

2204 851 dx | 2204 852 sx

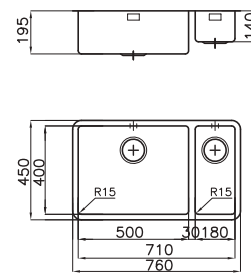

2203 850

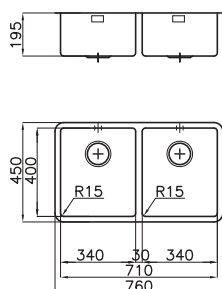

2202 851 dx | 2202 852 sx

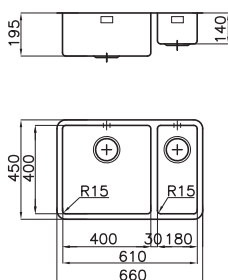

2201 851 dx | 2201 852 sx

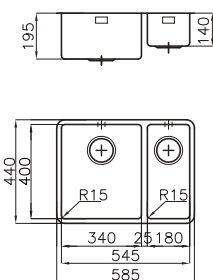

2157 850

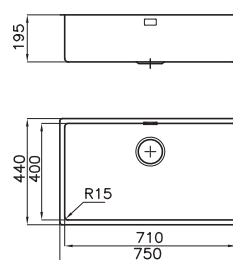

2155 850

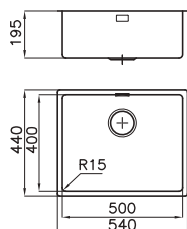

2154 850

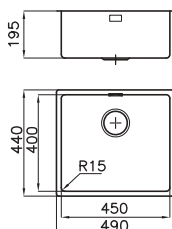

2156 850

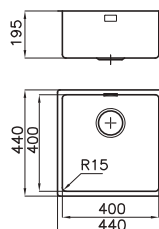

2153 850

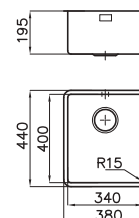

2152 850

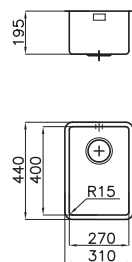

2151 850

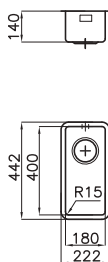

KE | R15 con fissaggio facilitato **NEW**
sottotop

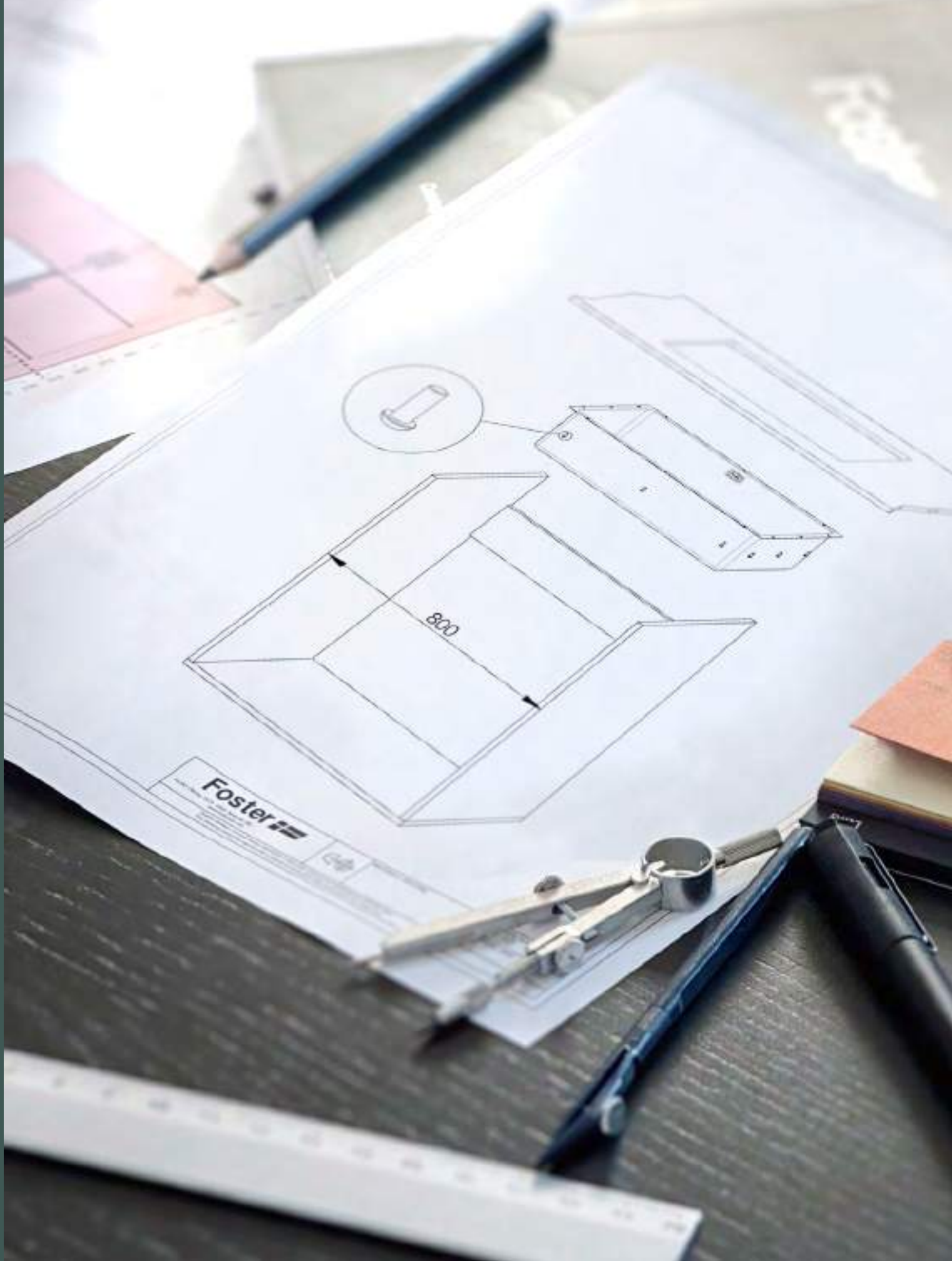

KE R15 con fissaggio facilitato **NEW**

sottotop

Codice

Versione

Caratteristiche

Prezzo

■ Base 80

2157 840

ST

incasso: 710 x 400 R15



- Acciaio AISI 304 satinato
- Dimensioni: **750 x 440** - 1 vasca: **710 x 400**
- Piletta 3½"

Accessori, disegno tecnico
e pilette automatiche a pag. 274

■ Base 60

2155 840

ST

incasso: 500 x 400 R15



- Acciaio AISI 304 satinato
- Dimensioni: **540 x 440** - 1 vasca: **500 x 400**
- Piletta 3½"

Accessori, disegno tecnico
e pilette automatiche a pag. 274

La cartella forata

permette l'installazione senza l'utilizzo delle squadrette.
Non è necessario scaricare le spalle delle basi
per il passaggio delle squadrette di fissaggio.

B3

Griglia Black
39 x 42 cm
8100 617



B7

Griglia Black
38 x 48 cm
8100 652



B8

Griglia Black
38 x 69 cm
8100 653



L4

Tagliere cristallo
23x41 cm
8631 300



N2

Tagliere in HDPE
27,2x42,5 cm
8657 001



N3

Tagliere Twin
in HDPE 31,7x41,8
8644 101



O2

Vaschetta bianca
27,2x41,4 cm
8153 100



K7

Kit tagliere in legno
Iroko 42 x 31,7 cm
con vaschetta
scolapasta
in acciaio inox
8644 044



K8 *

Kit grattugie con
anello-supporto e
vaschetta vivande
8159 101



R2

Cestello Inox
34x40 cm
8611 000



R3

Cestello Inox
40x40
8612 000



T1

Cestello portapiatti
inox 25x42,5 cm
8100 201



T2 *

Cestello portapiatti
inox 21,4x37,9 cm
8100 303



Z2 *

Vaschetta forata
inox 21,5x38 cm
8151 000



Disponibile anche in versione PVD



Gun Metal
8151 006



Copper
8151 008



Gold
8151 009

2157 840 **B3 B8 L4 N2 N3 O2 K7 K8**
R2 R3 T1 T2 Z2

2155 850 **B3 B7 L4 N2 N3 O2 K7 K8**
R2 R3 T1 T2 Z2

pilette automatiche opzionali

2157 840 **PA PE PM PL PP**

2155 850 **PA PE PM PL PP**

Vedi pag. 298

* utilizzabile solo in abbinamento al tagliere N3

2157 840

2155 840

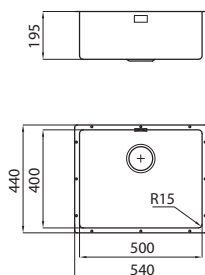
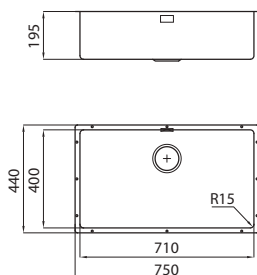

Fissaggio facilitato

Grazie alla cartella forata è possibile installare la vasca senza l'utilizzo delle classiche squadrette.



S400 | R30

sottotop



Base 80



Accessori, disegno tecnico
e pilette automatiche a pag. 277

Base 60



Accessori, disegno tecnico
e pilette automatiche a pag. 277

Codice

1870 850

Versione

ST

Caratteristiche

incasso: 730 x 400 R30

Prezzo

- Acciaio AISI 304 satinato
- Dimensioni: **756 x 426** - 1 vasca: **730 x 400**
- Piletta 3½"

1865 850

ST

incasso: 530 x 400 R30

- Acciaio AISI 304 satinato
- Dimensioni: **556 x 426** - 1 vasca: **530 x 400**
- Piletta 3½"

S400

accessori



B3

Griglia Black
39 x 42 cm
8100 617



N2

Tagliere in HDPE
27,2x42,5 cm
8657 001



N3

Tagliere Twin
in HDPE 31,7x41,8
8644 101



O2

Vaschetta bianca
27,2x41,4 cm
8153 100



K8 *

Kit grattugie con
anello-supporto e
vaschetta vivande
8159 101



R3

Cestello Inox
40x40 - 8612 000



K7

Kit tagliere in legno
Iroko 42 x 31,7 cm
con vaschetta
scolapasta
in acciaio inox
8644 044

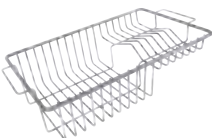

T1

Cestello portapiatti
inox 25x42,5 cm
8100 201



T2 *

Cestello portapiatti
inox 21,4x37,9 cm
8100 303



Z2 *

Vaschetta forata
inox 21,5x38 cm
8151 000

Disponibile anche in versione PVD



Gun Metal
8151 006



Copper
8151 008



Gold
8151 009

1870 850 **B3 N2 N3 O2 K8 R3 K7 T1**
T2 Z2

1865 850 **B3 N2 N3 O2 K8 R3 K7 T1**
T2 Z2

pilette automatiche opzionali

1870 850 **PA PE PM PL PP**

1865 850 **PA PE PM PL PP**

Vedi pag. 298

S400 disegni tecnici

1870 850

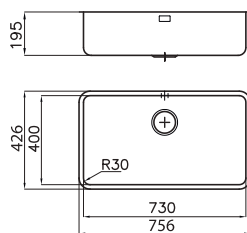

1865 850

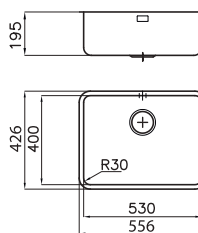

* utilizzabile solo in abbinamento al tagliere N3

Big Bowl

sottotop



Base 60



Accessori, disegno tecnico
e pilette automatiche a pag. 279

Codice

1811 050

Versione

— **ST**

Caratteristiche

incasso: 450 x 400 R95

Prezzo

- Acciaio AISI 304 satinato
- Dimensioni: **475 x 425** - 1 vasca: **450 x 400**
- Piletta 3½"

Base 30



Accessori, disegno tecnico
e pilette automatiche a pag. 279

1300 068

— **ST**

incasso: 150 x 300 R50

- Acciaio AISI 304 satinato
- Dimensioni: **170 x 320** - 1 vasca: **150 x 300**
- Piletta 3½"

Big Bowl | accessori



L4

Tagliere cristallo
23x41 cm
8631 300



N2

Tagliere in HDPE
27,2x42,5 cm
8657 001



R3

Cestello Inox
40x40
8612 000



Z1

Scolapasta Inox
17,3x32
8154 043

1811 050 L4 N2 R3

1300 068 Z1

pilette automatiche opzionali

1811 050 PR PQ PC

1300 068 PR

Vedi pag. 298

LAVELLI
SOTTOTOP

Big Bowl | disegni tecnici

1811 050

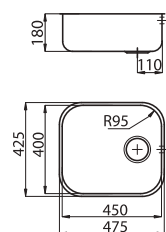

1300 068

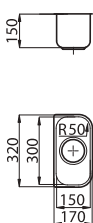

Tornado

sottotop



Base 80



Codice	Versione	Caratteristiche	Prezzo
--------	----------	-----------------	--------

1679 860

— ST

incasso: 750 x 460 R125

- Acciaio AISI 304 satinato
- Dimensioni: **816 x 524** - 1 vasca: **730 x 440**
- Piletta Automatica 3½"

Accessori, disegno tecnico
e pilette automatiche a pag. 281

Tornado | accessori



P5

Tagliere
37x30 cm
8659 111



P4

Tagliere Twin
37x46
8644 003



O2

Vaschetta bianca
41,4x27,2 cm
8153 100



Z4

Scolapasta bianco
17x32 cm
8151 100



T *

Griglia portapiatti
inox 25x35 cm
8100 154



T7

Griglia portapiatti
inox 25x45 cm
8100 111

1679 860 **P5 P4 O2 Z4 T T7**

* utilizzabile solo in abbinamento al tagliere P4

LAVELLI
SOTTOTOP

Tornado | disegni tecnici

1679 860

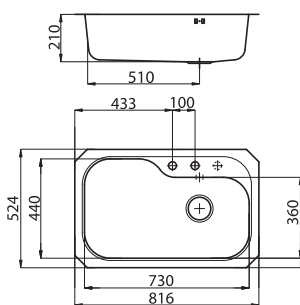

KS | R60

sottotop



Base 80

NEW



Accessori, disegno tecnico
e pilette automatiche a pag. 284

Codice

1303 860

Versione

ST

Caratteristiche

incasso: 715 x 400 R60

Prezzo

- Acciaio AISI 304 satinato
- Dimensioni: **761 x 446** - 2 vasche: **340 x 400**
- Piletta 3½"

Base 60

1850 850

ST

incasso: 501 x 401 R60



Accessori, disegno tecnico
e pilette automatiche a pag. 284

- Acciaio AISI 304 satinato
- Dimensioni: **539 x 436** - 1 vasca: **500 x 400**
- Piletta 3½"

KS | R60

sottotop

Codice

Versione

Caratteristiche

Prezzo

■ Base 60

1845 850

ST

incasso: 451 x 401 R60



- Acciaio AISI 304 satinato
- Dimensioni: **488 x 438** - 1 vasca: **450 x 400**
- Piletta 3½"

Accessori, disegno tecnico
e pilette automatiche a pag. 284

LAVELLI
SOTTOTOP

■ Base 60

1840 850

ST

incasso: 401 x 401 R60



- Acciaio AISI 304 satinato
- Dimensioni: **436 x 436** - 1 vasca: **400 x 400**
- Piletta 3½"

Accessori, disegno tecnico
e pilette automatiche a pag. 284



L4

Tagliere cristallo
23x41 cm
8631 300



N2

Tagliere in HDPE
27,2x42,5 cm
8657 001



O2

Vaschetta bianca
27,2x41,4 cm
8153 100



R3

Cestello Inox
40x40 - 8612 000

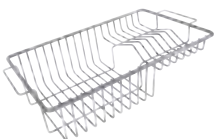

T1

Cestello portapiatti
inox 25x42,5 cm
8100 201



K7

Kit tagliere
in legno Iroko
42 x 31,7 cm
con vaschetta
scolapasta
in acciaio inox
8644 044

1303 860 L4 N2 O2 K7

1850 850 L4 N2 O2 R3 T1 K7

1845 850 L4 N2 O2 R3 T1 K7

1840 850 L4 N2 O2 R3 K7

pilette automatiche opzionali

1303 860 PR PQ PC

1850 850 PA PE PM PL PP

1845 850 PA PE PM PL PP

1840 850 PA PE PM PL PP

Vedi pag. 298

1303 860

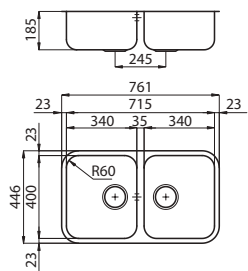

1850 850

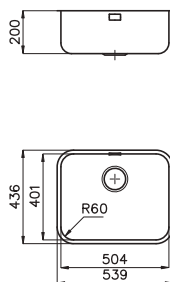

1845 850

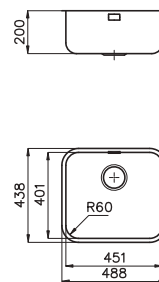

1840 850

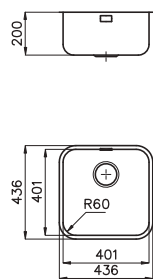

Accessori e complementi



Un'ampia gamma di accessori realizzati per potersi adattare a tutte le esigenze.

Dai taglieri in legni pregiati ai cestelli, agli scolapasta in acciaio inox, una serie di complementi che rendono i lavelli **Foster** delle vere e proprie postazioni di lavoro dove cucinare diventa un piacere.

Un piacere anche per gli occhi poiché tutti gli accessori Foster sono caratterizzati da quel design che ha fatto di Foster un punto di riferimento.

L'utilizzo di materiali all'avanguardia conferisce a questi prodotti un'alta durabilità ed una garanzia di sicurezza.

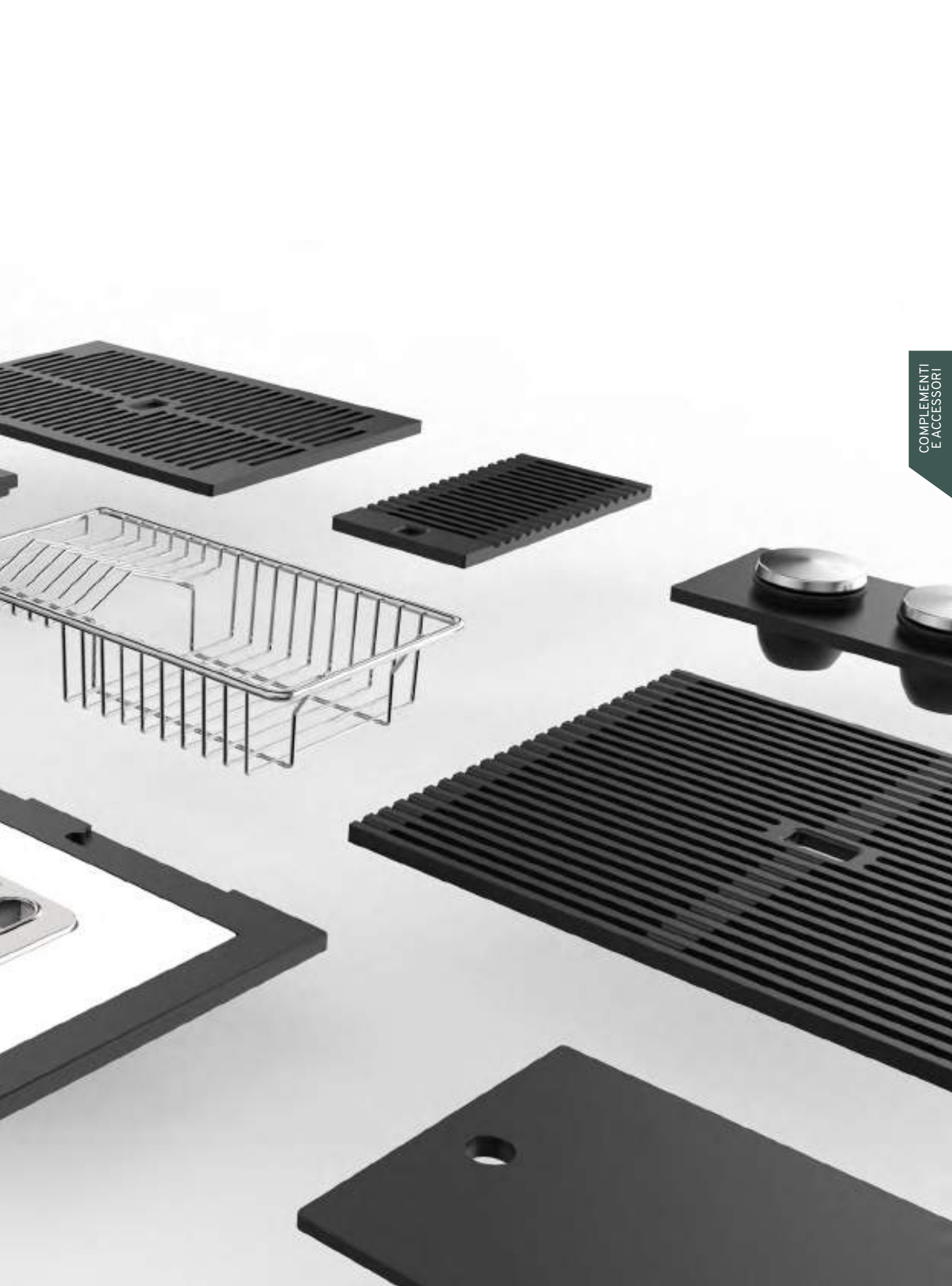

COMPLEMENTI
E ACCESSORI

Accessori

Una dotazione sempre più ricca di accessori caratterizza le proposte lavaggio. Tutti i modelli si accompagnano con **taglieri**, **vaschette**, **griglie scolapiatti** e **colapasta** che arricchiscono l'estetica rendendo il lavello una postazione di lavoro funzionale.

Lavelli



Accessori

Spazio e tempo, elementi sempre più preziosi in cucina. Per questo Foster ha studiato **sistemi integrati di accessori che ottimizzano ogni vostro movimento**, e si riducono al minimo ingombro quando non li usate.

Lavelli - set modulari





Un kit multiuso



Natura e Tecnologia **Accessori Black**



Ecologici

- Carta/Cartone riciclati al 100% impregnati con resina **Petrofree** pigmentata ricavata dalla spremitura di gusci di anacardi e di pigmenti naturali.
- Certificati **FSC**



Atossici

- Certificati per l' idoneità al contatto con cibi.
- Nessun residuo di Formaldeide, né VOC.

Resistenti

- Agli impatti, ai graffi, all'abrasione.
- Alla temperatura: resiste fino a 180°C senza presentare modificazioni superficiali.

Facili da pulire

- Lavabili in lavastoviglie

Idrorepellenti

Design focused

- Belli e leggeri, con una texture piacevole al tatto.

Griglia Black polifunzionale



COMPLEMENTI
E ACCESSORI



Pratiche e scorrevoli

Diventano un comodo
gocciolatoio



Ruotando di 90°

Possono essere adagiate
sul fondo vasca per diventare un

**Gocciolatoio
Salvafondo**



Taglia flusso

Grazie alle scanalature tra le asole
che impediscono all'acqua di zampillare
sul piano di lavoro

Griglie e accessori **Black**

B1

Griglia Black
42,7 x 45 cm
8100 615



B2

Griglia Black
31 x 45 cm
8100 614



B3

Griglia Black
39 x 42 cm
8100 617



B4

Griglia Black
36,8 x 34,2 cm
8100 618



B5

Griglia Black
37,2 x 42,4 cm
8100 602



B6

Griglia Black
38 x 38 cm
8100 651



B7

Griglia Black
38 x 48 cm
8100 652



B8

Griglia Black
38 x 69 cm
8100 653



Accessori **Black**

B9

Griglia Black
39,2x44,8 cm
8100 600



K1

Kit cornice supporto
28x47,4
multiaccessori con
tagliere HDPE
8100 627



K2

Kit cornice
supporto
multiaccessori
con tagliere
Black
44,8 x 28,9 cm
8100 037



X1

Vaschetta inox
forata
12,6 x 12,1 cm
8151 001



Da utilizzare abbinato a

K2 **8100 037**

X2

Porta coltelli
8542 655



K3

Porta spezie
44,8 x 10 cm
8100 620



K4

Porta
bottiglie
44,8 x 14 cm
8100 621



X3

Porta
coltelli
8100 030



Abbinabile solamente a

K4 **8100 621**

K5

3 vaschette con
coperchio inox
44,8 x 18 cm
8100 622



K6

Vaschetta con
coperchio inox
e ciotola
44,8 x 28 cm
8100 628



Accessori

K7

Kit tagliere
in legno Iroko
42 x 31,7 cm
con vaschetta
scolapasta
in acciaio inox
8644 044



P1

Tagliere
41,4 x 32 cm
in legno Iroko
8648 002



P2

Tagliere
39,5 x 22,5 cm
in legno noce
8642 004



P3

Tagliere
26x36,6 cm
in legno Iroko
8643 117



P4

Tagliere Twin
in legno Iroko
37x46 cm
8644 003



P5

Tagliere
in legno Iroko
37x30 cm
8659 111



P6

Tagliere
in legno noce
18x44,8 cm
8642 000



N2

Tagliere
in HDPE
27,2x42,5 cm
8657 001



N3

Tagliere Twin
in HDPE
31,7x41,8 cm
8644 101



K8

Kit grattugie con
anello-supporto e
vaschetta raccogli
vivande.
8159 101

Da utilizzare abbinato a

N3 8644 101

K2 8100 037

K1 8100 627



T

Griglia
portapiatti inox
25x35 cm
8100 154



T1

Cestello
portapiatti inox
25x42,5 cm
8100 201

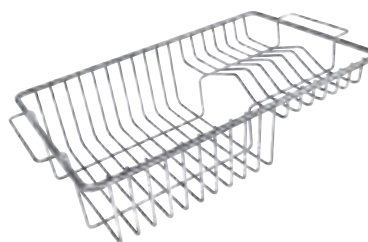

Da utilizzare abbinato a

P4 8644 003

T2

Cestello
portapiatti inox
21,4x37,9 cm
8100 303

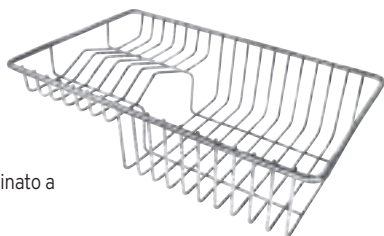

T3

Griglia
portapiatti inox
28x40 cm
8100 280



Da utilizzare abbinato a

N3 8644 101

K2 8100 037

K1 8100 627

T5

Cestello
portapiatti inox
21,4x33,1 cm
8100 304

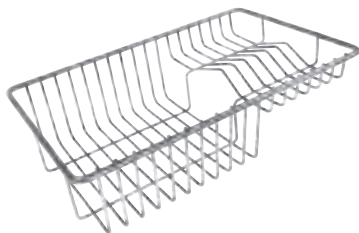

Accessori

T6

Griglia
portapiatti inox
23x37,5 cm
8100 305

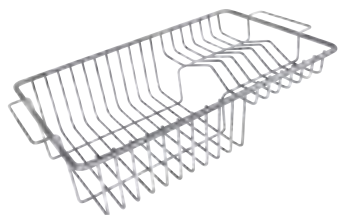

T8

Griglia
portapiatti inox
21,4x37,2 cm
8100 306



T7

Griglia
portapiatti inox
25x45 cm
8100 111



R1

Portavaschetta
inox
37x45 cm
8100 112



Da utilizzare abbinato a

O1 8152 100

R2

Cestello inox
34x40 cm
8611 000

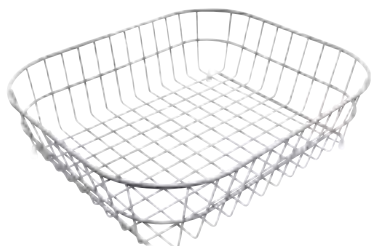

R3

Cestello inox
40x40 cm
8612 000



O1

Vaschetta
bianca
36x30 cm
8152 100



O2

Vaschetta bianca
41,4x27,2 cm
con tappo in dotazione
8153 100



Z4

Scolapasta
bianco
17x32 cm
8151 100



L4

Tagliere
in cristallo
23x41 cm
8631 300



L5

Tagliere
in cristallo
29x54 cm
8633 300



Z2

Vaschetta forata inox 21,5x38 cm
8151 000

Disponibile anche
in versione PVD



Gun Metal
8151 006

Z5



Copper
8151 008

Z6



Gold
8151 009

Z7



Da utilizzare abbinato a

N3 8644 101

K2 8100 037

K1 8100 627

Z3

Vaschetta
forata inox
21,5x40 cm
8156 000



Z1

Scolapasta
inox
17x32 cm
8154 043



Complementi

Pilette automatiche **Space**

PL



8407 117 Piletta automatica **Space Light** con comando remoto ad azionamento elettrico luminoso e con troppo/pieno perimetrale. Doppio tappo in dotazione: Space e "a cestello".

PP



8407 116 Piletta automatica **Space Push** con comando remoto rotondo a pressione e con troppo/pieno perimetrale. Doppio tappo in dotazione: Space e "a cestello".

PO



8407 120 Piletta automatica **Space Push Gun Metal** con comando remoto rotondo a pressione e con troppo/pieno perimetrale. Doppio tappo in dotazione: Space e "a cestello".

PB



8407 122 Piletta automatica **Space Push Copper** con comando remoto rotondo a pressione e con troppo/pieno perimetrale. Doppio tappo in dotazione: Space inox e "a cestello".

PD



8407 121 Piletta automatica **Space Push Gold** con comando remoto rotondo a pressione e con troppo/pieno perimetrale. Doppio tappo in dotazione: Space inox e "a cestello".

PS



8407 115 Piletta automatica **Space Milano** con comando remoto rotondo rotante e con troppo/pieno perimetrale. Doppio tappo in dotazione: Space e "a cestello".

PA



8407 108 Piletta automatica **Space** con comando remoto quadrato rotante e con troppo/pieno perimetrale. Doppio tappo in dotazione: Space e "a cestello".

PE



8407 109 Piletta automatica **Space** con comando remoto rotondo rotante e con troppo/pieno perimetrale. Doppio tappo in dotazione: Space e "a cestello".

Per installazioni sul piano di lavoro, tutte le pilette automatiche necessitano di foro Ø 35 mm

Complementi

Caratteristiche pilette automatiche **Space**



Pensato per vasche profonde, Space ha un ingombro molto contenuto. Nel disegno è presentata la vista laterale del sistema Space. L'altezza ridotta della piletta e la conformazione del sifone ottimizzano l'area sotto-lavello lasciando lo spazio necessario per le esigenze di raccolta differenziata.



Il tappo Space raccoglie i residui alimentari nel **cestello flessibile in neoprene** sottostante, molto facile da pulire.



Le nuove pilette automatiche **Space Light** e **Push** sono ancora più comode e permettono l'apertura dello scarico con un semplice tocco della mano.

Pilette automatiche



Note sulla compatibilità delle pilette automatiche

Le pilette automatiche sono compatibili con lavelli che hanno in dotazione almeno un secondo foro (oltre a quello del miscelatore).

Per molti lavelli questa non è una dotazione standard ma è possibile richiederla in fase d'ordine. Nei disegni dei lavelli sono riportati con tratto continuo i fori in dotazione standard, con tratteggio sottile le posizioni per eventuali fori su richiesta (vedi esempio qui sotto).

Per i lavelli sottotop è sempre segnalata la possibilità di inserimento della piletta automatica in quanto il foro è posizionabile sul piano di lavoro. Si raccomanda inoltre di controllare la tipologia del troppo-pieno del lavello per scegliere una piletta automatica compatibile.

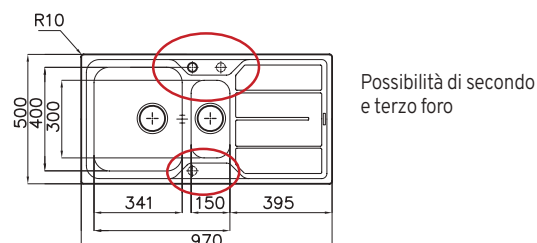







Per installazioni sul piano di lavoro, tutte le pilette automatiche necessitano di foro \varnothing 35 mm

Complementi

Pilette Space 3"½

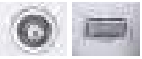
	Codice	Descrizione	Prezzo
	8403 008	Piletta Space senza troppo pieno	
	8403 308	Piletta Space con troppo pieno perimetrale	
	8669 012	Tappo inox Space con cestello in silicone senza foro per pilette autom.	
	8669 066	Tappo inox Space con cestello in silicone senza foro per pilette aut. GUN METAL	
	8669 068	Tappo inox Space con cestello in silicone senza foro per pilette aut. COPPER	
	8669 069	Tappo inox Space con cestello in silicone senza foro per pilette aut. GOLD	
	8669 011	Tappo inox Space con cestello in silicone con foro per pilette manuali	

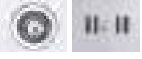
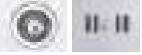

Pilette 3"½

	Codice	Descrizione	Prezzo
	8403 000	Piletta basket senza troppo pieno	
	8403 014	Piletta basket satinata senza troppo pieno	
	8403 303	Piletta basket con troppo pieno perimetrale	
	8403 310	Piletta troppo pieno a mostrina 3,5" GUN METAL	
	8403 312	Piletta troppo pieno a mostrina 3,5" COPPER	
	8403 311	Piletta troppo pieno a mostrina 3,5" GOLD	
	8403 325	Piletta troppo pieno a mostrina 3,5" SUNSET	
	8403 300	Piletta basket con troppo pieno	
	8407 200	Piletta Uragano per vasca profonda (t/p con tubo flessibile)	

Pilette Lira 3"½

	Codice	Descrizione	Prezzo
	8403 001	Piletta Basket LIRA senza troppo pieno	
	8403 301	Piletta Basket LIRA con troppo pieno	

Pilette 2"

	Codice	Descrizione	Prezzo
	8401 000	Piletta 2" con tappo a maniglia con troppo pieno	
	8402 000	Set pilette 2" con tappo a maniglia 1 con t/p + 1 senza t/p	

Piletta 1"¼

	Codice	Descrizione	Prezzo
	8404 000	Piletta-troppo pieno 1"¼ per gocciolatoio	

Varie



	Codice	Descrizione	Prezzo
	8669 000	Tappo a maniglia in gomma 2"	
	8669 018	Tappo a cestello per piletta 3"½	
	8669 030	Tappo a cestello con piletta 3"½ GUN METAL	
	8669 031	Tappo a cestello con piletta 3"½ COPPER	
	8669 032	Tappo a cestello con piletta 3"½ GOLD	
	8669 019	Tappo a cestello con piletta automatica 3"½	
	8669 033	Tappo a cestello con piletta automatica 3"½ GUN METAL	
	8669 058	Tappo a cestello con piletta automatica 3"½ COPPER	
	8669 059	Tappo a cestello con piletta automatica 3"½ GOLD	
	8700 007	Sigillante per incasso lavelli con bordo da 4 e 8 mm	
	8700 062	Sigillante per incasso lavelli con bordo ribassato e filotop	
	8700 080	Kit 18 adattatori per fissaggio ganci su top da 20 mm *	
	8669 009	Mostrina STD per T/p perimetrale con logo con supporto	
	8669 029	Mostrina STD per T/p perimetrale con logo con supporto GUN METAL	
	8669 028	Mostrina STD per T/p perimetrale con logo con supporto COPPER	
	8669 026	Mostrina STD per T/p perimetrale con logo con supporto GOLD	
	8669 008	Kit mostrina lunga per T/p perimetrale con logo con supporto	
	8401 001	Prolunga collegamento piletta/TP 15 cm	
	8660 000	Rosetta copriforo	

Complementi

Sifoni

	Codice	Descrizione	Prezzo
	8410 000	Sifone a 1 via con attacco lavastoviglie	
	8415 000	Sifone a 2 vie con attacco lavastoviglie	
	8435 000	Sifone tipo "Spazio" a 2 vie con attacco lavastoviglie	

Sifoni Lira salvaspazio

	Codice Codice	Descrizione Descrizione	Prezzo Prezzo
	8435 002	Sifone LIRA* tipo "Spazio" a 2 vie con attacco lavastoviglie	
	8435 003	Sifone LIRA* ispezionabile a 1 via con attacco lavastoviglie	

Sifoni a pavimento

codice	Descrizione	Prezzo
8411 000	Sifone a pavimento 1 via con attacco lavastoviglie	
8416 000	Sifone a pavimento 2 vie con attacco lavastoviglie	

* si consiglia di abbinare sifoni e pilette tipo LIRA

COMPLEMENTI
E ACCESSORI

Pattumiere



Codice | Prezzo

8143 000

Split 2

Sistema per raccolta differenziata a 2 scomparti 12+12L estraibile

Base min 30 cm

Coperchi colorati per facile riconoscimento scomparti

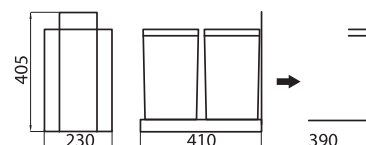

tot. 24 lt min 30 cm



Codice | Prezzo

8119 000

Patty top

Pattumiera con accesso dal top e sacchetto estraibile dall'alto dotata di coperchio in acciaio inox (capienza 13 litri).



tot. 13 lt min 30 cm

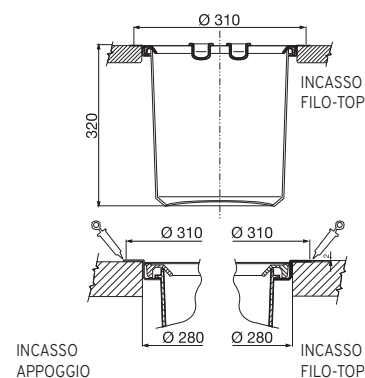



Complementi

Colonnine portaprese



Codice | Prezzo

8000 011

Totem4 inox

Torretta portaprese estraibile

- 2 prese Schuko
 - 1 presa ITA 3 poli 10A-16A
 - 1 presa USB per ricarica
- Cavo alimentazione in dotazione
Con tappo inox satinato

Foro incasso: $\varnothing 102$ mm - Spessore top: max 50 mm

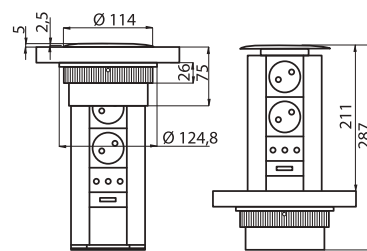

Codice | Prezzo

8000 012

Totem3

Torretta portaprese estraibile

- 2 prese Schuko
 - 1 presa ITA 3 poli 10A-16A
- Cavo alimentazione in dotazione
Con tappo verniciato grigio

Foro incasso: $\varnothing 102$ mm - Spessore top: max 50 mm

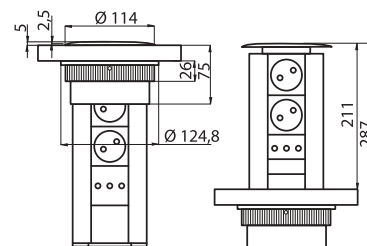

Codice | Prezzo

8000 014

Casper

Torretta portaprese estraibile push

- 2 prese Schuko
- Cavo alimentazione in dotazione

Foro incasso: $\varnothing 80$ mm - Spessore top: max 60 mm

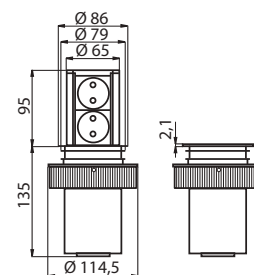

NEW

Codice | Prezzo

8000 018

Casper Black

Torretta portaprese estraibile push

- 2 prese Schuko
- Cavo alimentazione in dotazione

Foro incasso: $\varnothing 80$ mm - Spessore top: max 60 mm

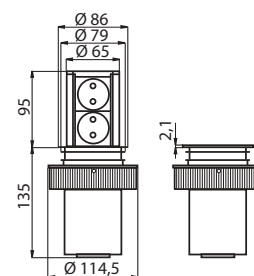

Codice | Prezzo

8000 214

Kit per installazione a pensile

Solo per torrette Casper. 8000 014, 8000 018

Complementi

Portaprese **da incasso**



Codice	Finitura	Prezzo
8000 010	Satinato	
8000 117	Vintage	
8000 116	Gun Metal	
8000 119	Gold	
8000 118	Copper	



Reverse

Slot portaprese push in acciaio inox per incasso su piani da lavoro

- 2 prese Schuko - 1 presa USB per ricarica

Foro incasso: 215x88 mm

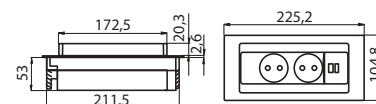

Codice	Prezzo
8000 113	

Filo3

Slot portaprese push per incasso su piani da lavoro

- 2 prese Schuko
- 1 presa ITA 3 poli 10A-16A

Cavo alimentazione in dotazione
Altezza massima del top 40 mm (per top di spessore superiore e per incasso filotop, vedere libretto istruzioni).

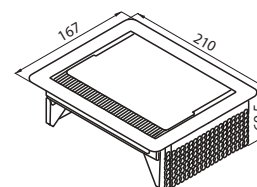

Codice	Prezzo
8000 015	

Cip

Portaprese per incasso su piani da lavoro

- 1 presa Schuko

Cavo alimentazione in dotazione
Foro incasso: Ø 56 mm

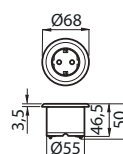

Accessori

- 8000 215 kit copertura colore bianco
- 8000 115 kit copertura colore grigio acciaio
- 8000 315 kit copertura colore nero



Codice	Prezzo
8000 017	

Cip-Cip

Slot portaprese da incasso con copripresa slide color grigio acciaio

- 2 prese Schuko

Cavo alimentazione in dotazione

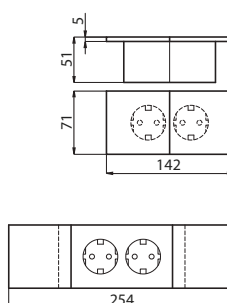

Accessori

- 8000 217 kit copripresa colore bianco
- 8000 317 kit copripresa colore nero



Complementi



NEW

Codice | Prezzo

8000 028

Circle Black Slot portaprese da incasso con copripresa

- 2 prese Schuko

Cavo alimentazione in dotazione
Foro incasso: Ø 105 mm
Altezza massima del top 40 mm (per top di spessore superiore e per incasso filotop, vedere libretto istruzioni).

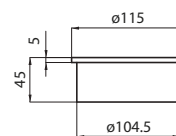

Prodotti pulizia acciaio

I prodotti in acciaio inossidabile non hanno bisogno di manutenzione particolare; tuttavia è opportuno adottare alcuni accorgimenti e utilizzare detergenti adeguati per la pulizia quotidiana.

In generale sono sufficienti un lavaggio con acqua calda e sapone o acqua calda e aceto, un abbondante risciacquo e un'asciugatura con un panno. Sono da evitare: l'acido cloridrico, polveri abrasive, pagliette, spazzole e sostanze per pulire l'argento.

Per orientarvi nella scelta dei detergenti, Foster propone i prodotti della linea "Steel Clean" per la pulizia dell'acciaio:

- **panno in microfibra**, per eliminare velocemente tracce di unto, grasso e polvere.
- **crema professionale** per restituire l'originale splendore all'acciaio, rimuove incrostazioni di calcare, sporco ostinato ed eventuali macchie di ruggine causate dal contatto prolungato di oggetti ferrosi.



Steel Clean - crema

Crema detergente per acciaio inox | Codice | Prezzo

flacone 250 ml **8331 000**

confezione 12 pz. **8331 012**



Steel Clean - microfibra

Panni in morbida microfibra per la pulizia dell'acciaio inox | Codice | Prezzo

confezione 3 pz. **8333 000**

12 confezioni da 3 pz. **8333 012**

Miscelatori





MISCELATORI



312	Skin <small>NEW</small>	324	Lorenzo	333	S1000 Z65
313	Tube	324	Monza <small>NEW</small>	333	S1000 Z85
314	Iota <small>NEW</small>	325	Omega Plus <small>NEW</small>	334	S1000 RO
315	Play	326	Omega Plus Matt Black	335	Eclipse
316	Milanello	326	Omega	336	Margot <small>NEW</small>
317	FL	327	Omega Matt Black	337	Flat
318	GK	328	Delta	338	Arsenio
319	Magnum	328	Delta Plus	339	Drop
320	Camillo	329	KS	340	Dispenser Quadra
320	1/2 Circle	329	KS Plus	340	Dispenser Round
321	NYC	330	Snake <small>NEW</small>	341	Dispenser Evo
321	Master	331	Atomo <small>NEW</small>		
322	Gamma 3 vie	331	Atomo Plus <small>NEW</small>		
323	Gamma	332	F2000 Alto		
323	KE	332	Bite		



Miscelatori **Foster**

Igiene e salute

Massima sicurezza
alimentare

Garantita dall'utilizzo di materiali di altissima qualità

Grande robustezza

Funzionamento
fluidico e preciso

Grazie all'utilizzo di cartucce ceramiche
e a flessibili testati ad altissime pressioni.



Comando Slim

Comando ad ingombro ridotto che nasconde il meccanismo di apertura

Piastra di rinforzo

Tutti i miscelatori hanno in dotazione la piastra di rinforzo che fornisce perfetta stabilità.

AISI 316 Inox AISI 316

Soluzioni in acciaio inox AISI 316 satinato, che garantiscono una perfetta resistenza alla corrosione e la massima igiene e sicurezza, anche per acqua ad uso alimentare.

AISI 304 Inox AISI 304

Valorizza al meglio la vasta gamma di lavelli, garantendo una sicurezza anche per acqua ad uso alimentare.

Tre vie

I flussi di acqua filtrata e depurata sono separati dai flussi di acqua fredda e acqua calda in modo che rimangano divisi per tutto il loro percorso.

>50 Bocca estraibile

La bocca del miscelatore è estraibile per poter raggiungere agevolmente ogni zona del lavello.

Cartucce ceramiche

Tutti i miscelatori sono dotati di cartucce ceramiche che garantiscono la massima precisione e durabilità.

360° Rotazione canna

Tutti i miscelatori sono dotati di un ampio angolo di rotazione. Alcuni modelli permettono una rotazione completa di 360°.

Canna abbattibile

Caratteristica che rende possibile progettare la zona lavello davanti ad una finestra, potendo così godere della luce naturale.

Canna pieghevole

Ideale per l'installazione sotto finestra.

Doppio flusso d'acqua

Molti modelli sono dotati di comando per cambiare agevolmente la modalità del getto d'acqua da flusso continuo a pioggia.

Canna snodabile

Maneggevole e versatile per raggiungere ogni zona del lavello.

Foro Ø 35

Tutti i miscelatori necessitano di un foro del diametro di 35 mm sul top.



Codice | Prezzo

- Miscelatore monocomando
- Canna girevole e snodabile
- Base d'appoggio: Ø 50 mm

8424 100
 satinato

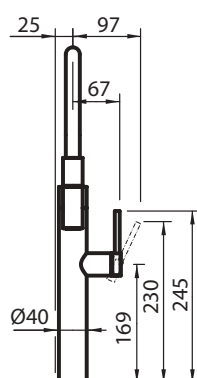
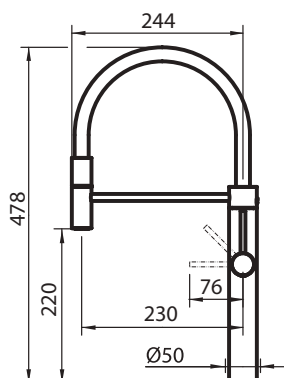

• Disponibile anche in versione **PVD**

Satinato Gun Metal
8424 856



pag. 34

Satinato Copper
8424 858



pag. 54

Satinato Gold
8424 859



pag. 72

Satinato Sunset
8424 851



pag. 88

Caratteristiche



Tube



MISCELATORI

Codice

Prezzo

- Miscelatore monocomando
- Canna girevole e doccia snodabile
- Base d'appoggio: \varnothing 55 mm

8477 100
 satinato

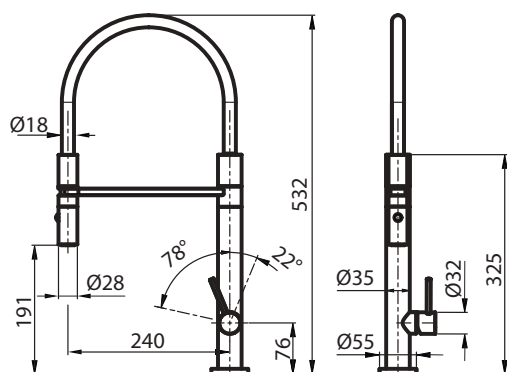
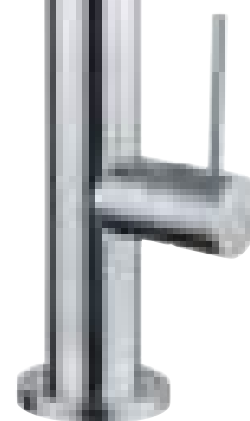

Caratteristiche





Codice	Prezzo
--------	--------

- Miscelatore monocomando
- Canna girevole e bocca estraibile
- Base d'appoggio: \varnothing 50 mm

8426 000
cromato

8426 100
satinato

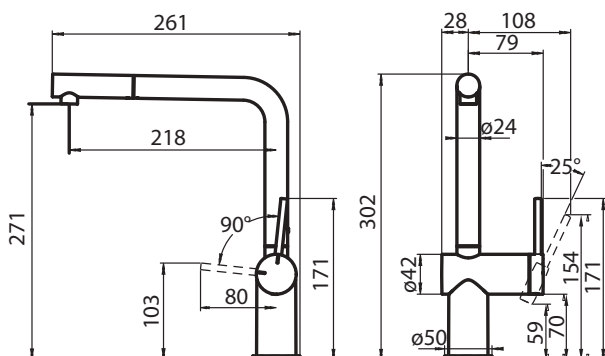
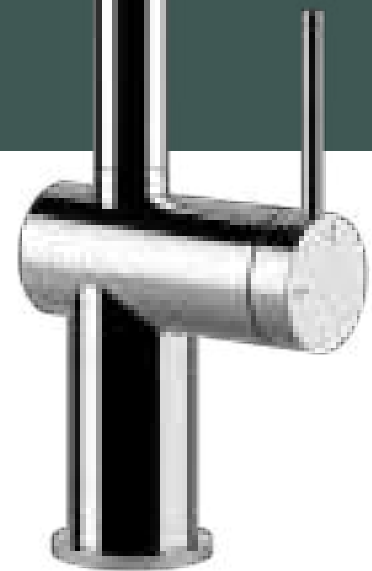

- Disponibile anche in versione **PVD**

Satinato
Gun Metal
8426 106



pag. 35

Caratteristiche





Codice

Prezzo

- Miscelatore monocomando
- Canna girevole e bocca snodabile
- Base d'appoggio: ø 50 mm

8487 000
cromato

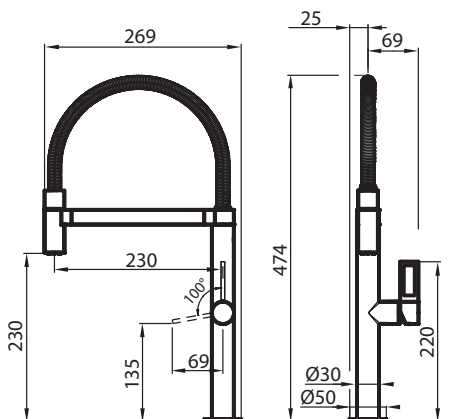

Caratteristiche



Milanello



Codice

Prezzo

- Miscelatore monocomando
- Canna girevole e doccia snodabile
- Calza in acciaio inox
- Base d'appoggio: \varnothing 50 mm

8425 100
satinato

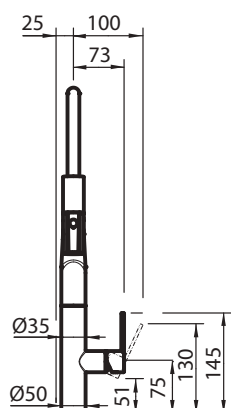
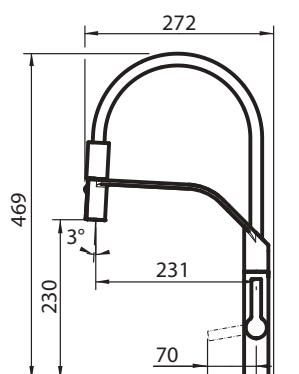

Caratteristiche





Codice

Prezzo

- Miscelatore monocomando
- Canna girevole e doccia snodabile
- Base appoggio: 48x48 mm

8521 000
cromato

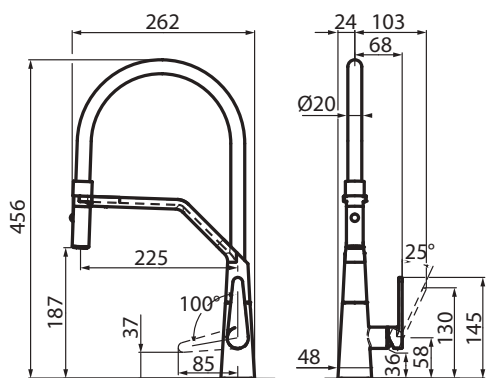

Caratteristiche





Codice

Prezzo

- Miscelatore monocomando
- Canna girevole e snodabile
- Base d'appoggio: 62 x 46 mm

8488 000
cromato

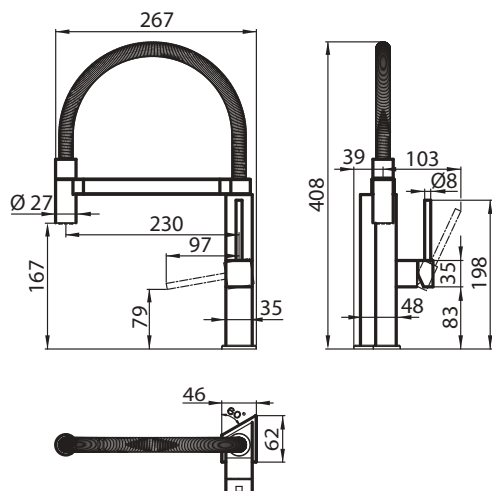

La base del miscelatore ha una forma irregolare, si raccomanda di verificare gli ingombri per l'abbinamento con i lavelli

Caratteristiche



Magnum



MISCELATORI

Codice

Prezzo

- Miscelatore monocomando
- Canna girevole e doccia snodabile
- Base d'appoggio: \varnothing 50 mm

8484 000
cromato

Caratteristiche

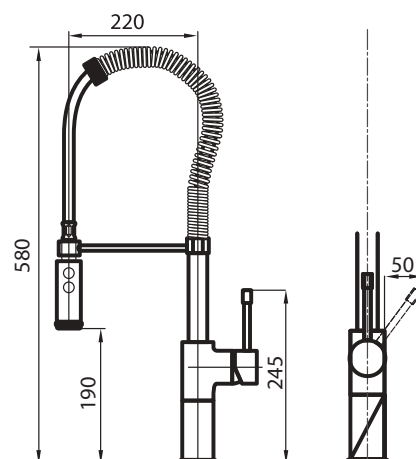

Camillo

Codice

Prezzo



- Miscelatore monocomando
- Canna girevole e bocca estraibile
- Base d'appoggio: \varnothing 48 mm

8467 000
cromato

8467 100
satinato

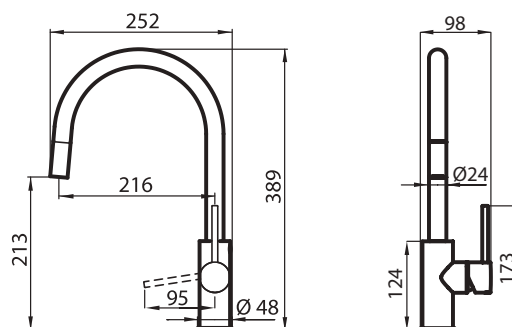

Caratteristiche



1/2 Circle

Codice

Prezzo



- Miscelatore monocomando
- Canna girevole
- Base d'appoggio: \varnothing 50 mm

8480 001
cromato

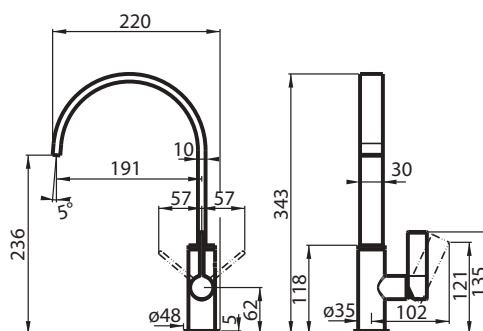

Caratteristiche



NYC

Codice

Prezzo



- Miscelatore monocomando
- Canna girevole
- Base d'appoggio: \varnothing 50 mm

8486 000
cromato

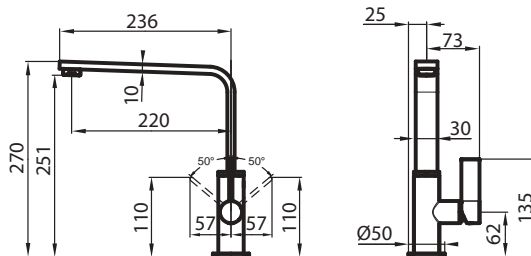

Caratteristiche



Master

Codice

Prezzo



- Miscelatore monocomando
- Canna girevole
- Base d'appoggio: 48x48 mm

8493 000
cromato

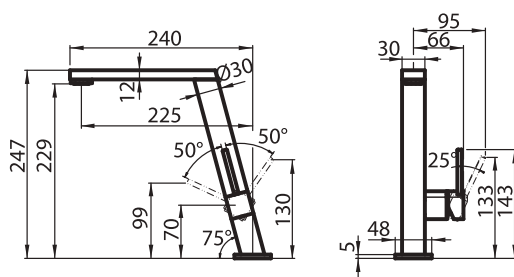

Caratteristiche



MISCELATORI

Gamma 3 vie



Codice | Prezzo

- Miscelatore a tre vie con doppio comando
- Canna girevole.
- Le tre vie permettono erogazione di acqua calda/fredda e filtrata per uso alimentare.
- Parti estetiche in acciaio AISI 316
- Base d'appoggio: \varnothing 50 mm

**8496 100
satinato**

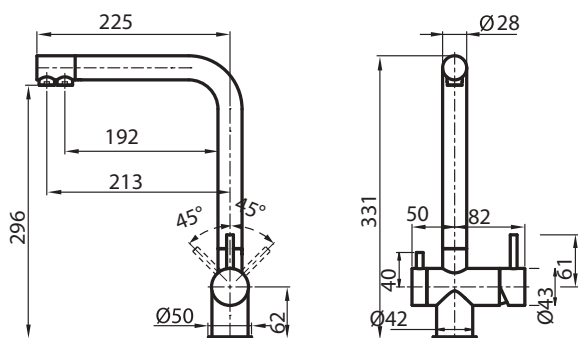

Caratteristiche



Gamma

Codice

Prezzo



- Miscelatore monocomando
- Canna girevole e bocca estraibile
- Base d'appoggio: \varnothing 50 mm

8483 001
cromato

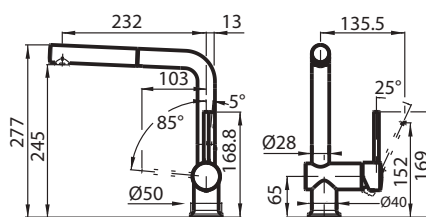

Caratteristiche



MISCELATORI

KE

Codice

Prezzo



- Miscelatore monocomando
- Canna girevole e bocca estraibile
- Base d'appoggio: \varnothing 50 mm

8492 000
cromato

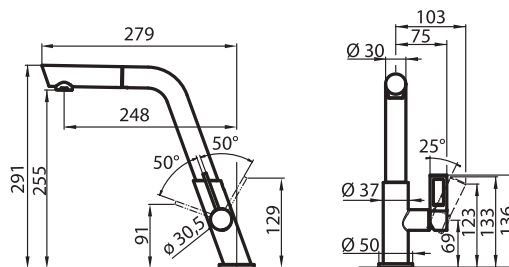

Caratteristiche



Lorenzo

Codice

Prezzo



- Miscelatore monocomando
- Canna girevole e bocca estraibile
- Base d'appoggio: \varnothing 48 mm

8466 000
cromato

8466 100
satinato

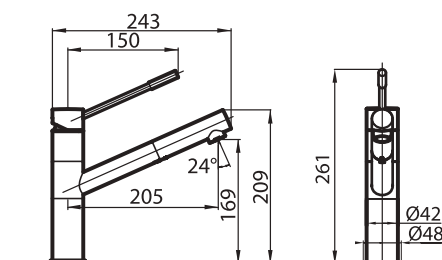

Caratteristiche



Monza NEW

Codice

Prezzo



- Miscelatore comando joystick
- Canna orientabile
- Base d'appoggio: \varnothing 50 mm

8549 000
cromato

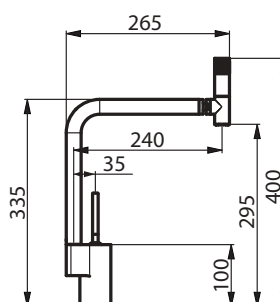

Caratteristiche



Omega Plus NEW

MISCELATORI



Codice | Prezzo

- Miscelatore monocomando
- Canna girevole e bocca estraibile
- Base d'appoggio: ø 50 mm

8497 020
cromato

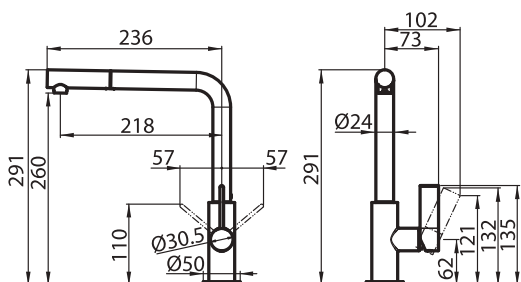

• Disponibile anche in versione **PVD**

Cromato
Gun Metal
8498 856



pag. 36

Cromato
Copper
8498 858



pag. 55

Cromato
Gold
8498 859



pag. 73

Cromato
Sunset
8498 851



pag. 89

Caratteristiche



Omega Plus Matt Black

Codice

Prezzo



- Miscelatore monocomando
- Canna girevole e bocca estraibile
- Base d'appoggio: Ø 50 mm

8498 626
matt black

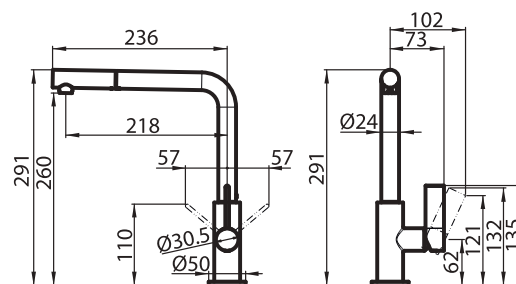

Caratteristiche



Omega

Codice

Prezzo



- Miscelatore monocomando
- Canna girevole
- Base d'appoggio: Ø 50 mm

8497 000
cromato

8497 100
satinato

- Disponibile anche in versione **PVD**

Cromato
Gun Metal
8497 856

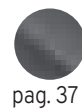

Cromato
Copper
8497 400

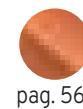

Cromato
Gold
8497 700

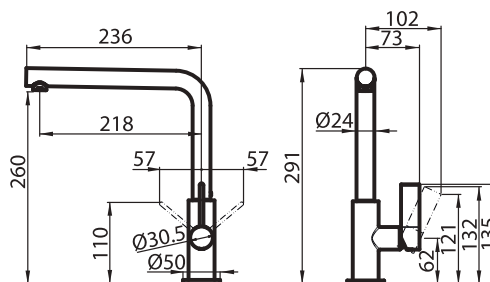
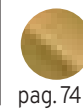

Caratteristiche



Omega Matt Black

Codice

Prezzo



- Miscelatore monocomando
- Canna girevole
- Base d'appoggio: \varnothing 50 mm

8497 606
matt black

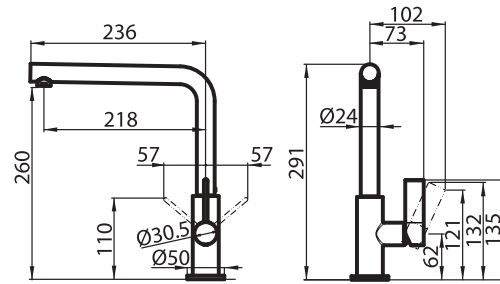

Caratteristiche



Delta

Codice

Prezzo



- Miscelatore monocomando
- Canna girevole
- Base d'appoggio: \varnothing 48 mm

8441 000
cromato

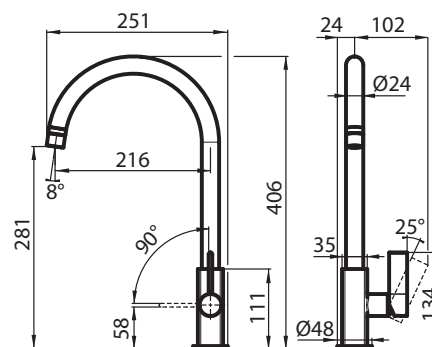

Caratteristiche



Delta Plus

Codice

Prezzo



- Miscelatore monocomando
- Canna girevole e bocca estraibile
- Base d'appoggio: \varnothing 48 mm

8441 030
cromato

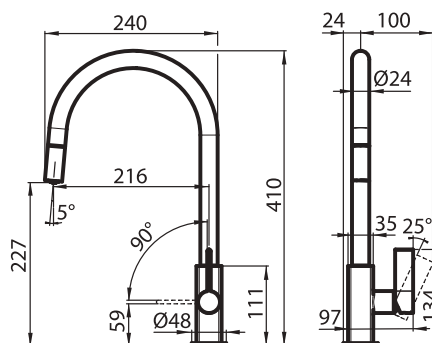

Caratteristiche



KS

Codice

Prezzo



- Miscelatore monocomando
- Canna girevole
- Base d'appoggio: \varnothing 48 mm

8485 002
cromato

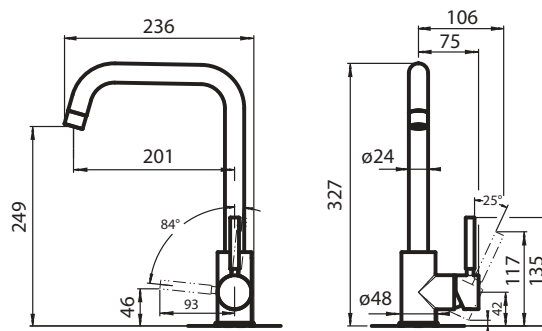

Caratteristiche



KS Plus

Codice

Prezzo



- Miscelatore monocomando
- Canna girevole e bocca estraibile
- Base d'appoggio: \varnothing 50 mm

8522 000
cromato

8522 100
satinato

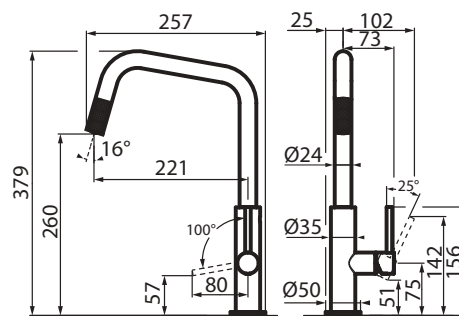

Caratteristiche





Codice

Prezzo

- Miscelatore monocomando
- Canna girevole e snodabile
- Base d'appoggio: \varnothing 50 mm

8525 000
cromato

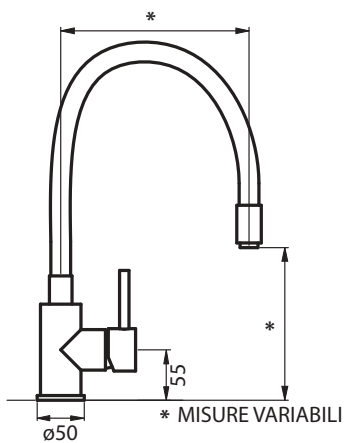

La canna è snodabile e mantiene la forma.

Caratteristiche



Atomo NEW

Codice

Prezzo



- Miscelatore monocomando
- Canna girevole e bocca estraibile
- Base d'appoggio: \varnothing 50 mm

8550 000
 satinato

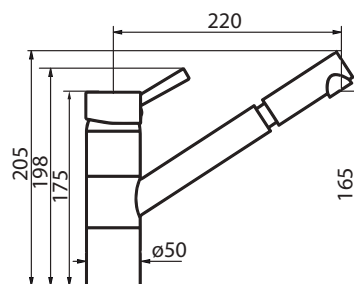

Caratteristiche



Atomo Plus NEW

Codice

Prezzo



- Miscelatore monocomando
- Canna girevole e bocca estraibile
- Base d'appoggio: \varnothing 48 mm

8551 000
 satinato

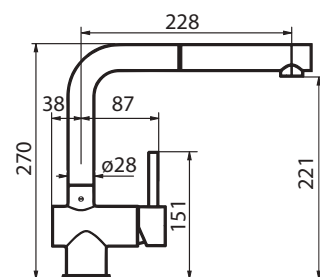

Caratteristiche



F2000 - Alto

Codice

Prezzo



- Miscelatore monocomando
- Canna girevole
- Base d'appoggio: \varnothing 50 mm

8458 001
cromato

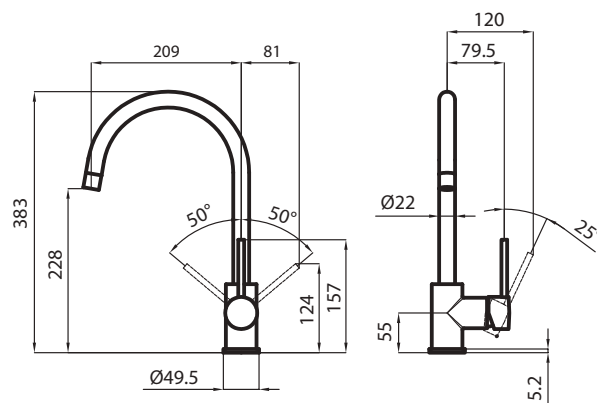

Caratteristiche



Bite

Codice

Prezzo



- Miscelatore monocomando
- Canna girevole
- Base d'appoggio: \varnothing 54 mm

8481 000
cromato

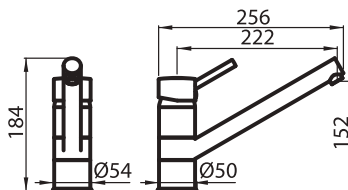

Caratteristiche



S1000 - Z65

Codice

Prezzo



- Miscelatore monocomando
- Canna girevole e doccia estraibile
- Base d'appoggio: \varnothing 55 mm

8449 500
cromato

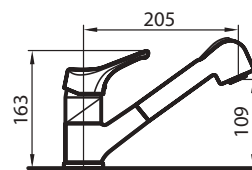

Caratteristiche



MISCELATORI

S1000 - Z85

Codice

Prezzo



- Miscelatore monocomando
- Canna girevole
- Base d'appoggio: \varnothing 48 mm

8442 500
cromato

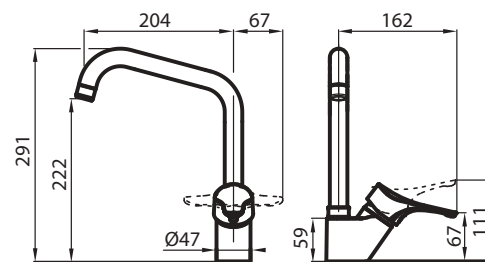

Caratteristiche



S1000 - RO

Codice

Prezzo



- Miscelatore monocomando
- Canna girevole
- Base d'appoggio: \varnothing 50 mm

8443 002
cromato

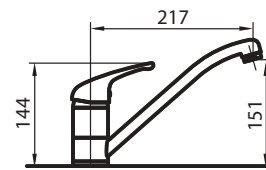

Caratteristiche



Eclipse

abbattibile

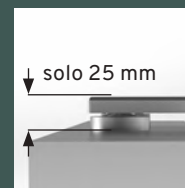

solo 25 mm

minimo ingombro

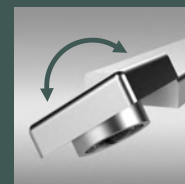

testina girevole



Codice

Prezzo

8499 000
cromato

- Miscelatore monocomando
- Canna girevole a scomparsa (up & down)
- Base d'appoggio: \varnothing 44 mm
- Ingombro posteriore massimo (per rotazione comando) 40 mm dal centro del foro
- Comando remoto
- Rotazione testina: 60°
- Interasse mixer/comando: vedi sito web

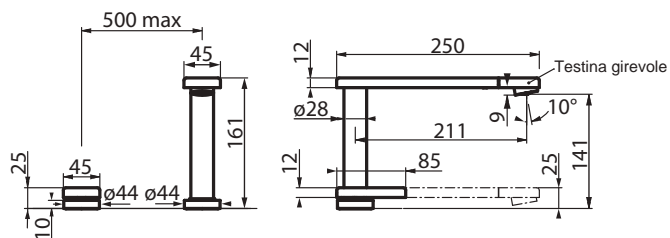

Caratteristiche



Margot

abbattibile

NEW



Codice

Prezzo

- Miscelatore monocomando
- Canna girevole a scomparsa (up & down)
- Base d'appoggio: \varnothing 55 mm

8524 000
cromato

8524 100
satinato

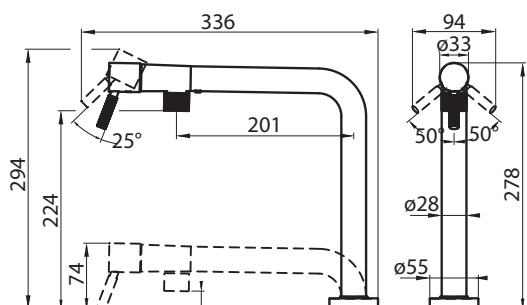
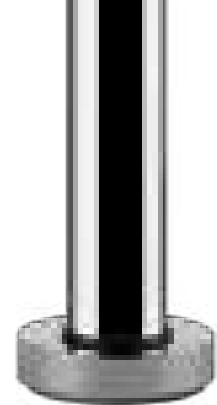

- Disponibile anche in versione PVD

Cromato
Gun Metal
8524 006



pag. 38

Cromato
Copper
8524 008



pag. 57

Cromato
Gold
8524 009



pag. 75

Caratteristiche



Flat

abbattibile



Codice

Prezzo

8478 001
cromato

- Miscelatore monocomando
- canna girevole a scomparsa (Up&Down)
- Comando remoto
- Distanza fori: max 500 mm - min. 85 mm
- Base d'appoggio: \varnothing 52 mm

Caratteristiche

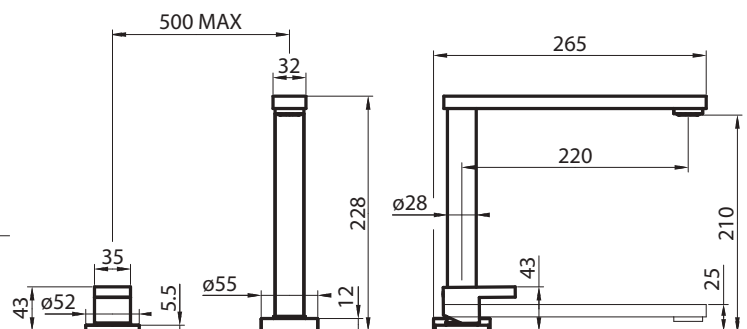

Arsenio

abbattibile



Codice

Prezzo

- Miscelatore monocomando
- Canna girevole a scomparsa (Up&Down)
- Bocca estraibile
- Comando remoto
- Distanza fori: max 500 mm - min. 85 mm
- Base d'appoggio: \varnothing 52 mm

8471 000
cromato

Caratteristiche

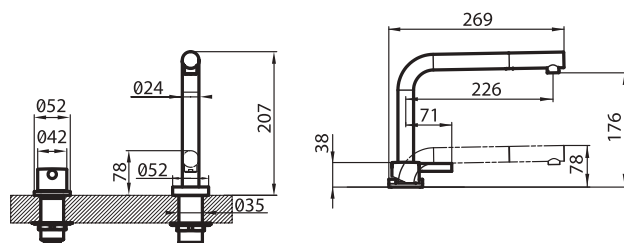

Drop

girevole



Codice

Prezzo

- Miscelatore monocomando
- Canna girevole e abbattibile
- Base d'appoggio: \varnothing 48 mm

8523 000
cromato

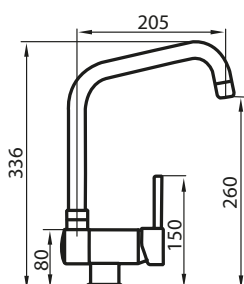

Caratteristiche



Dispenser Quadra

Caratteristiche

Codice

Prezzo



Distributore da incasso
per detersivo/sapone liquido

8520 000
cromato

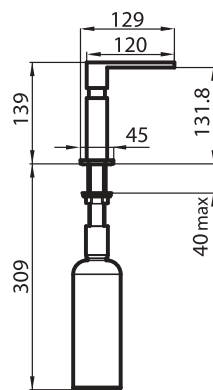

Dispenser Round

Caratteristiche

Codice

Prezzo



Distributore da incasso
per detersivo/sapone liquido

8530 000
cromato

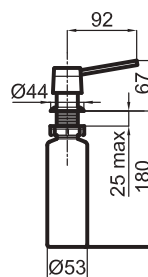

Dispenser Evo

Caratteristiche

Codice

Prezzo



Distributore da incasso per detersivo/
sapone liquido

8520 010
cromato

8520 100
satinato

- Disponibile anche
in versione **PVD**

Cromato
Gun Metal
8520 856



pag. 39

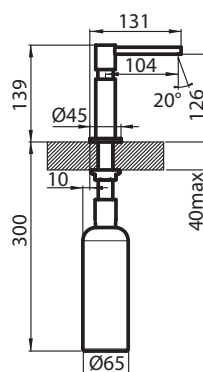

Canali attrezzati 





CANALI
ATTREZZATI



Canali attrezzati **NEW**

I canali attrezzati, accessoriati con una combinazione di elementi posizionabili a piacere, muovibili ed intercambiabili diventano soluzioni ottimali per completare l'utilizzo del piano di lavoro.

347	Canali attrezzati sopratop
348	Canali attrezzati sottotop
350	Accessori
353	Canali attrezzati slim sopratop
354	Canali attrezzati slim sottotop
356	Accessori canali slim
357	Disegni tecnici
358	Lavello Galante



Canali attrezzati

sopratop | filotop

Codice

Versione

Caratteristiche

Prezzo

3024 800

FT

incasso FT: vedi sito web*

SPT

incasso SPT: 432 x 152

- Acciaio AISI 304 satinato
- Dimensioni esterne: **450 x 170** Dimensioni interne: **422 x 142**
- Piletta 1¼"
- Lunghezza "L": 3 unità



Accessori a pag. 350

Base 90

3025 800

FT

incasso FT: vedi sito web*

SPT

incasso SPT: 852 x 152

- Acciaio AISI 304 satinato
- Dimensioni esterne: **870 x 170** Dimensioni interne: **842 x 142**
- Piletta 1¼"
- Lunghezza "L": 6 unità



Accessori a pag. 350

Base 120

3026 800

FT

incasso FT: vedi sito web*

SPT

incasso SPT: 1132 x 152

- Acciaio AISI 304 satinato
- Dimensioni esterne: **1150 x 170** Dimensioni interne: **1122 x 142**
- Piletta 1¼"
- Lunghezza "L": 8 unità



Accessori a pag. 350

Canali attrezzati sottotop

Codice

Versione

Caratteristiche

Prezzo

Base 60

3024 880  **ST** incasso ST: 422 x 142

- Acciaio AISI 304 satinato
- Dimensioni esterne: **438 x 170** Dimensioni interne: **422 x 122**
- Piletta 1/4"
- Lunghezza "L": 3 unità



Accessori a pag. 350

Base 90

3025 880  **ST** incasso ST: 842 x 142

- Acciaio AISI 304 satinato
- Dimensioni esterne: **858 x 170** Dimensioni interne: **842 x 122**
- Piletta 1/4"
- Lunghezza "L": 6 unità



Accessori a pag. 350

Base 120

3026 880  **ST** incasso ST: 1122 x 142

- Acciaio AISI 304 satinato
- Dimensioni esterne: **1138 x 170** Dimensioni interne: **1122 x 122**
- Piletta 1/4"
- Lunghezza "L": 8 unità



Accessori a pag. 350

Nota per l'installazione

*Spessore consigliato per un abbinamento perfetto con gli accessori.

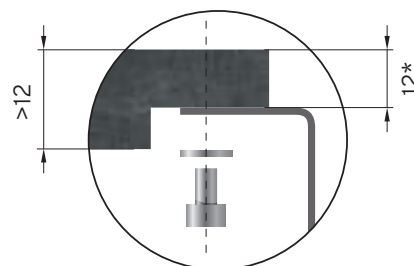
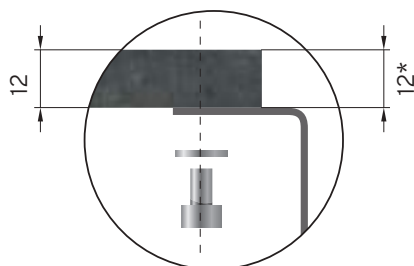

Chiave di lettura per gli accessori

Le lunghezze dei canali e degli accessori sono indicate in “unità”, per la composizione la somma delle “unità” degli accessori deve corrispondere alla lunghezza in “unità” del canale.

Canali attrezzati **sopratop**

Es. canale 3026 800 da “L8 unità” composto da:
8151 023 “L2 unità”, 1773 100 “L2 unità”, 8100 703 “L4 unità”.



Canali attrezzati **sottotop**

Es. canale 3026 800 da “L8 unità” composto da:
1773 100 “L2 unità”, 8100 058 “L2 unità”, 8100 706 “L4 unità”.



Canali attrezzati | accessori

Vaschetta inox
tre scomparti
(Scomparti amovibili)
L=2
(28x14 cm)



Kit "A": Vaschetta inox cinque scomparti
Tagliere in iroko
Portabottiglie inox
L=4
(56x14 cm)
*nota 1



Gocciolatoio Black
8100 058
L=2
(28x14 cm)



Kit "B": Tagliere in iroko
Portabottiglie inox
All'interno della sede libera possono
essere alloggiati le seguenti griglie Black:
8100 617 Quadra R12 / Phantom / Quadra / KE
8100 602 Milanello
8100 600 Milano
L=4
(56x14 cm)
*nota 1



Portacoltelli inox
+ supporto Black
per appoggio lame
L=3
(42x14 cm)



Kit "N": (Solo per vasche Serie 35)
Tagliere in iroko
8643 117
Griglia Black
8100 618
Portabottiglie inox
L=4
(56x14 cm)



2 prese Schuko
1 presa USB per
ricarica
L=2
(28x14 cm)



I portaprese possono
essere inseriti solamente
alle estremità dei canali

Portacoltelli Black
abbinabile solamente a
8100 700, 8100 703,
8100 704, 8100 706,
8100 714

8100 030



Kit "D": portabottiglie
inox

8100 704

L=1
(14x14 cm)



Kit "E": Vaschetta con
coperchio inox

8100 705

L=2
(28x14 cm)



Kit "F": Bilancia multifunzione**
N° 2 ciotole in terracotta
con coperchio inox
N° 2 salini in vetro
N° 2 portabottiglie inox

8100 706

L=4
(56x14 cm)



Kit "G": Tagliere iroko
N° 2 ciotole in terracotta
con coperchio inox
Bilancia multifunzione**
*nota 1

8100 710

L=3
(42x14 cm)



Kit "H": N° 2 ciotole in
terracotta con
coperchio inox
Vaschetta con
coperchio inox

8100 702

L=3
(42x14 cm)



Portapiatti inox

1773 100

L=2
(28x14 cm)



Kit "C": N° 2 ciotole
in terracotta
con coperchio
inox

8100 701

L=2
(28x14 cm)



*nota 1: Il tagliere è utilizzabile solamente nella vasche con profondità 400 mm

** Caratteristiche bilancia: Dimensione 21,4 x 16,5 cm - Portata max 5 kg.
Collegamento bluetooth allo smartphone
Accesso gratuito all'app smartapple
Banca dati con più di 430 alimenti precaricati.



Canali attrezzati **Slim**

sopratop | filotop

Codice

Versione

Caratteristiche

Prezzo

3024 801

FT

incasso FT: vedi sito web*

SPT

incasso SPT: 400 x 100

- Acciaio AISI 304 satinato
- Dimensioni esterne: **430 x 110** Dimensioni interne: **390 x 90**
- Piletta 1¼"
- Lunghezza "L": 1 unità



Accessori a pag. 356

Base 90

3025 801

FT

incasso FT: vedi sito web*

SPT

incasso SPT: 840 x 100

- Acciaio AISI 304 satinato
- Dimensioni esterne: **870 x 110** Dimensioni interne: **830 x 90**
- Piletta 1¼"
- Lunghezza "L": 3 unità



Accessori a pag. 356

Canali attrezzati **Slim**

sottotop

Codice

Versione

Caratteristiche

Prezzo

Base 45

3024 881  **ST** incasso ST: 390 x 90

- Acciaio AISI 304 satinato
- Dimensioni esterne: **406 x 120** Dimensioni interne: **390 x 72**
- Piletta 1/4"
- Lunghezza "L": 1 unità



Accessori a pag. 356

Base 90

3025 881  **ST** incasso ST: 830 x 90

- Acciaio AISI 304 satinato
- Dimensioni esterne: **846 x 120** Dimensioni interne: **830 x 72**
- Piletta 1/4"
- Lunghezza "L": 3 unità



Accessori a pag. 356

Nota per l'installazione

*Spessore consigliato per un abbinamento perfetto con gli accessori.

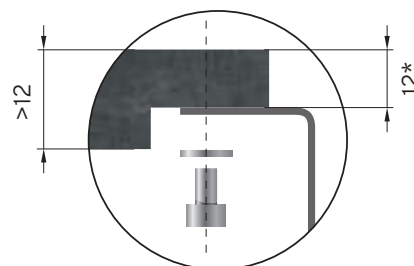
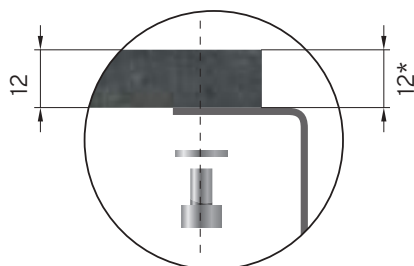

Chiave di lettura per gli accessori

Le lunghezze dei canali e degli accessori sono indicate in “unità”, per la composizione la somma delle “unità” degli accessori deve corrispondere alla lunghezza in “unità” del canale.

Canali attrezzati **Slim sopratop**

Es. canale 3025 801 da “L3 unità” composto da:
8100 708 “L2 unità”, 8151 004 “L1 unità”.



Canali attrezzati **Slim sottotop**

Es. canale 3025 881 da “L3 unità” composto da:
8100 708 “L2 unità”, 8151 004 “L1 unità”.



Canali attrezzati **Slim** | accessori

Kit "M": Tagliere in iroko 8100 709
 All'interno della sede libera
 possono essere alloggiati
 le seguenti griglie:
 8100 602 Milanello
 8100 617 Quadra R12,
 Phantom, Quadra, KE
 8100 600 Milano
 *nota 1

L=2
 (44x8,8 cm)



Kit "L": Tagliere in iroko 8100 708
 Bilancia multifunzione**
 *nota 1

L=2
 (44x8,8 cm)



Kit "I": Tagliere in iroko 8100 707
 All'interno della sede
 libera possono essere
 alloggiati le seguenti
 griglie:
 8100 602 Milanello
 *nota 1

L=1
 (38,8x8,8 cm)



Kit "O": (Solo per
 vasche Serie 35)
 Tagliere iroko
 8643 117
 Griglia Black
 8100 618

8100 715
 L=1
 (38,8x8,8 cm)



Vaschetta inox
 cinque scomparti
 (Scomparti amovibili)

8151 004
 L=1
 (38,8x8,8 cm)



*nota 1: Il tagliere è utilizzabile solamente nella vasche con profondità 400 mm

** Caratteristiche bilancia: Dimensione 21,4 x 16,5 cm - Portata max 5 kg.
 Collegamento bluetooth allo smartphone
 Accesso gratuito all'app smartapple
 Banca dati con più di 430 alimenti precaricati.

Canali attrezzati | disegni tecnici

Sopratop

3024 800

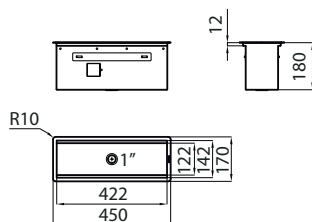

3025 800

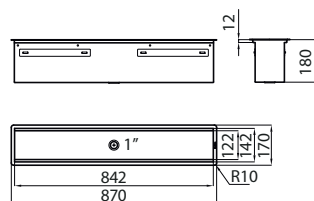

3026 800

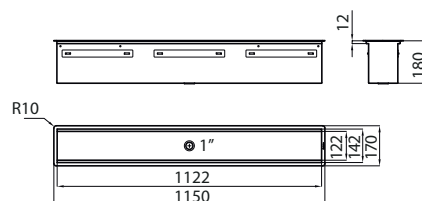

Sottotop

3024 880

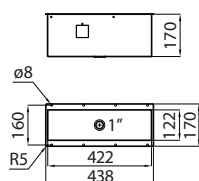

3025 880

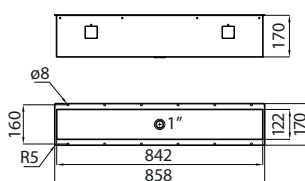

3026 880

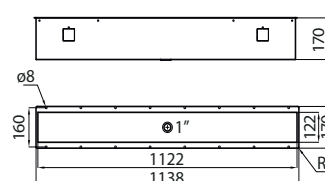

Canali attrezzati Slim | disegni tecnici

Sopratop

3024 801

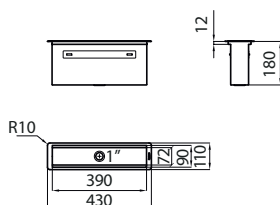

3025 801

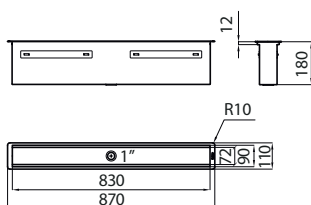

Sottotop

3024 881

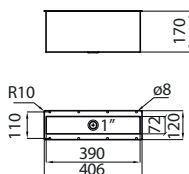

3025 881

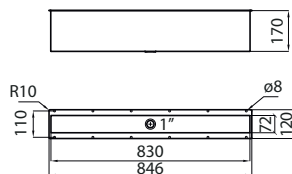

Lavello Galante **NEW**

sopratop | filotop | sottotop





Nuovo concetto di work station:

un canale attrezzato inserito all'interno del lavello permette di posizionare gli accessori in dotazione, tagliere e griglia Black, quando inutilizzati.

Un'ampia gamma di accessori

permette di creare una workstation personalizzata secondo le proprie esigenze.

CANALI
ATTREZZATI



Lavello Galante NEW

sopratop | filotop | sottotop

Codice

Versione

Caratteristiche

Prezzo

Base 90

3780 000

FT

incasso FT: vedi sito web

SPT

incasso SPT: 845 x 505 R10

ST

incasso ST: 830 x 490



- Acciaio AISI 304 satinato
- Dimensioni: **860 x 520** - 1 vasca: **830 x 350**
- Piletta automatica Space Push
- Possibilità di fori aggiuntivi

In dotazione: **griglia** (8100 618), **tagliere** (8643 117) e supporto Black

Accessori a fondo pagina

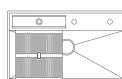

Configurazione griglia Black a filo vasca

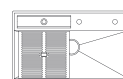

Configurazione griglia Black su fondo vasca

Lavello Galante | accessori in dotazione

Supporto Black

Griglia Black
36,8 x 34,2 cm
8100 618

Tagliere iroko
26x36,6 cm
8643 117



accessori opzionali

Vaschetta inox
5 scomparti (scomparti amovibili)
(38,8x8,8 cm)
8151 004

Griglia portapiatti inox
23x37,5 cm
8100 305

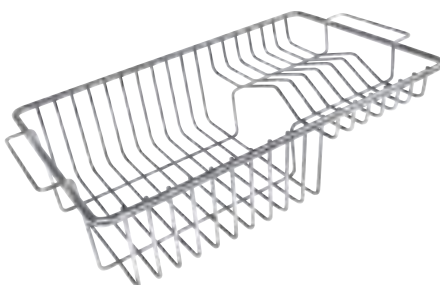

3780 000

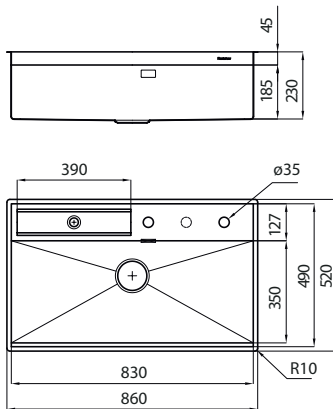

Schema di posizionamento degli accessori sugli invasi

Il sistema di “corsie” rende possibile l'utilizzo combinato di innumerevoli accessori. Griglie, taglieri, portautensili, vaschette e contenitori di varie dimensioni si alternano nella zona di lavoro con un semplice gesto e possono essere impilati, sempre a portata di mano.

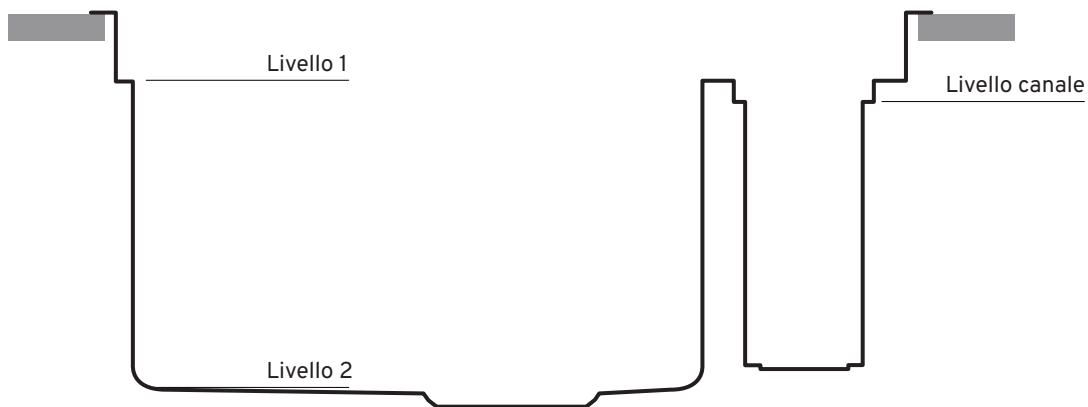

Piani induzione





PIANI
INDUZIONE

Piani induzione



Risparmio energetico

Controllo
preciso e versatile

Facilità di pulizia

L'elevata efficienza energetica, i nove settaggi di potenza e l'opzione powerboost garantiscono cotture precise e veloci. La zona di cottura attivandosi solo sul fondo della pentola mantiene freddo il resto del piano che grazie alla sua superficie liscia facilita ogni operazione di pulizia.

Esempi di assorbimenti per tipologie di cottura

livelli cottura	tipo cottura	esempi di utilizzo
1-2	molto dolce	fusioni, bagnomaria
3-4	dolce	riscaldare, sobbollire
5-7	media	sughi, riso
7-9	vivace	arrostiti, friggere
Powerboost	riduzione tempi	ebollizione liquidi

L'elevata potenza di cui sono dotati i piani a induzione Foster porta a pensare ad un grande impegno di energia. Come si può vedere in tabella, la maggior parte delle cotture richiede, al contrario, potenze ridotte.

Tipologie di incasso

I modelli ad induzione possono essere installati sia in appoggio che con lavorazione a filo, creando un ribasso nel top.

Incassi per piano con bordo bisellato



Bordo bisellato
Bordo inclinato (bisellato) che dona un'estetica pulita ed elegante e si abbina perfettamente con i lavelli Semifilo.

Incassi per piano con bordo verticale



Bordo verticale
Incasso con bordo di forma squadrata che sporge di soli 4 mm sul piano di lavoro.





Bridge

La funzione bridge permette di associare due zone formando un'unica estesa zona di cottura.



Power control

Massima libertà di utilizzo. L'utente può facilmente modificare il massimo assorbimento del piano secondo le proprie esigenze ed eventualmente riprogrammare per modificare o togliere i limiti di potenza in qualsiasi momento.



T-chef

Permette di impostare particolari temperature (42°C, 70°C, 94°C) e mantenerle costanti durante la cottura.



Powerboost

La funzione Booster [P] garantisce per alcuni minuti un aumento di potenza alla piastra selezionata.



Comando slider

È sufficiente sfiorare il display Touch per impostare il livello di potenza desiderata.



Sicurezza

Tutti i piani sono dotati delle più moderne e sofisticate protezioni: Spegnimento centralizzato; Blocco per la sicurezza; Indicatori di calore residuo; Safety System che spegne il piano in mancanza di pentole; Overflow detector, che spegne la piastra in caso di tracimazione di liquidi; Disattivazione automatica, per scongiurare incidenti causati da dimenticanze.



Pot Speed Test

Testa le vostre pentole, restituendo una classificazione da 0 a 3 in funzione dell'efficienza e velocità di riscaldamento.



Pausa

Permette di interrompere e ripristinare le modalità impostate in modo istantaneo.



Mantenimento calore

Permette di mantenere in temperatura (70° C) le vostre pietanze.



Chef cook

Una funzione da vero chef, il piano imposta automaticamente dei livelli di potenza a scalare nelle varie zone cottura, che si attivano automaticamente a contatto con la pentola. In questo modo è possibile cucinare a differenti livelli di potenza senza regolarli di volta in volta, semplicemente spostando la pentola sul piano.



Intelligent Pot Localization

Riconosce su quale zona viene appoggiata la pentola e attiva automaticamente i relativi comandi per la regolazione della potenza.



Double Powerboost

Due ulteriori regolazioni di potenza che raggiungono i 3700 W, utilizzabili su una singola zona o distribuiti sull'intera zona estesa del Bridge (dove presente).



Programmazione fine cottura

Ogni piastra è dotata di programmazione indipendente che permette di impostare differenti tempi di cottura.



Contaminuti

Ulteriore timer contaminuti svincolato dalla programmazione di fine cottura.



Pot Detector

Riconosce e calcola la superficie d'appoggio della pentola. Rimuovendo la pentola, le piastre si disattivano automaticamente.



Automatismo Go&Stop

Attiva le piastre inizialmente alla massima potenza, fino al raggiungimento del livello impostato.



Automatic Bridge

Quando una pentola invade 2 differenti zone, attiva automaticamente la funzione Bridge.



Recall

La funzione permette di richiamare in modo immediato le ultime impostazioni selezionate nella precedente cottura.



Smart fan system

La corretta ventilazione è essenziale per il funzionamento ottimale dei piani ad induzione. Il sistema Foster regola automaticamente il grado di ventilazione in funzione delle temperature raggiunte.



368	KE Arya Black	NEW
370	Milano Air	
375	KE Induction	NEW
378	S4000 Domino Line	
382	S1000	NEW
384	Serie Modular Induction	
388	Serie Modular Quadra	

KE Arya Black **NEW**



KE Arya Black NEW

MOTORE A BORDO



Alimentazione: mono-fase 230V~1P+N
 bi-fase 400V~2P+N
 frequenza 50÷60 Hz

Piano cottura ad induzione con cappa aspirante integrata

• Finitura: Vetroceramica nero

Caratteristiche induzione:

- Programmazione elettronica
- Doppia funzione Bridge
- Funzione PowerControl
- 9 settaggi di potenza per zona
- Funzione Powerboost
- Comandi touch control
- Pot detector
- Dotazioni di sicurezza.

Caratteristiche aspirazione:

- Funzionamento aspirante
- Programmazione elettronica
- 10 velocità di aspirazione (9 + 1 intensiva);
- 2 filtri antigrasso lavabili
- Spegnimento ritardato automatico
- Avvisi di saturazione filtri antigrasso e carbone
- Funzionamento filtrante opzionale con filtri carbone

• Classe energetica: A+

- m³/h max: 543
- m³/h int: 647
- pressione (PA): 610
- Rumorosità max (dbA): 66
- Rumorosità int (dbA): 70
- Potenza aspirazione (W): 165

Kit di canalizzazione filtrante: vedi pag. 373

Accessori canalizzazioni: vedi pag. 373

Codice	Versione	Caratteristiche	Prezzo
--------	----------	-----------------	--------

7392 246

SF

incasso SF: 760 x 480

FT

incasso FT: vedi sito web

Dimensione: 820 x 520

P. max assorbita 7.400 W**
 4 zone 210x190 mm 2.100 (3.000)* W
 2 zone estese Bridge 3.700 W

* Powerboost

** con la funzione PowerControl, la potenza max può essere impostata in utenza da 2.400 W a 7.400 W con step di 100 W



• Griglia disponibile anche in versione **PVD**

Inox satinato
8803 000



Gun Metal satinato
8803 116



Copper satinato
8803 118



Gold satinato
8803 119



PIANI
INDUZIONE

Foster Milano Air



Sei velocità di aspirazione

Sei velocità e una portata fino a 680 mc/h sono la garanzia di una aspirazione potente ed efficace in ogni situazione.



Raccolta acqua di trabocco

La vasca di contenimento sotto la griglia permette la raccolta di liquidi di trabocco fino ad 1.5 litri.



Superficie liscia

Milano Air è complanare, anche nella zona di aspirazione. Le pentole possono scorrere in sicurezza su tutto il piano.



Facile accesso ai filtri

La forma ergonomica della griglia permette un facile accesso ai filtri e alla vasca di raccolta per la pulizia.



Doppia zona Bridge

Foster Milano Air ha due ampie zone di cottura estese, che possono essere attivate tramite la funzione Bridge.



Controllo intuitivo



Il funzionale pannello touch comanda in modo semplice e immediato le zone di cottura e la funzione di aspirazione.

Foster Milano Air

MOTORE REMOTO

Codice	Versione	Caratteristiche	Prezzo
--------	----------	-----------------	--------



7391 245	 SF	incasso SF: 810 x 500	
	 FT	incasso FT: vedi sito web	

Dimensione: 860 x 530

P. max assorbita	3.000, 4.000, 7.400 W**
2 zone anteriori	Ø 160 mm 1.200 (1.600)* W
2 zone posteriori	Ø 200 mm 2.300 (3.000)* W
2 zone estese Bridge	3.700 W

* Powerboost

** con la funzione PowerControl, la potenza max può essere impostata in utenza ai valori riportati

Alimentazione: 230 - 380 V
50/60 Hz



Piano cottura ad induzione con cappa aspirante integrata

• Finitura: Vetroceramica nero

Caratteristiche induzione:

- Programmazione elettronica
- Doppia funzione Bridge
- Funzione PowerControl
- 9 settaggi di potenza per zona
- Funzione Powerboost
- Comandi touch control
- Pot detector
- Dotazioni di sicurezza.

Caratteristiche aspirazione:

- Funzionamento aspirante
- Programmazione elettronica
- 6 velocità di aspirazione (4 + 2 intensive);
- 2 filtri antigrasso lavabili
- Spegnimento ritardato automatico
- Avvisi di saturazione filtri antigrasso e carbone
- Funzionamento filtrante opzionale con filtri carbone

• Classe energetica: A++

- m³/h max: 500
- m³/h int: 680
- pressione (PA): 778
- Rumorosità max (dBa): 66
- Rumorosità int (dBa): 74
- Potenza aspirazione (W): 170

Kit di canalizzazione filtrante: vedi pag. 373

Accessori canalizzazioni: vedi pag. 373

Filtro carbone sottogriglia 9700 529

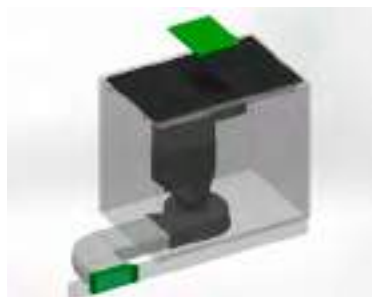

Allestimento filtrante con filtro carbone sottogriglia (9700529) e mascherina da zoccolo (9700539).



Allestimento filtrante con filtro da zoccolo (9700574).



Minimo ingombro. L'installazione del piano Foster Milano Air è semplice e versatile. Le geometrie della cappa lasciano abbondante spazio nel sottopiano con la possibilità di usufruire di due ampi cassettoni. Il motore, che risiede a terra sotto la base del cabinet, può essere ruotato per facilitare il deflusso dell'aria nella direzione più opportuna.

Accessori canalizzazioni



Kit canalizzazione filtrante KE Arya Black

Kit canalizzazione filtrante

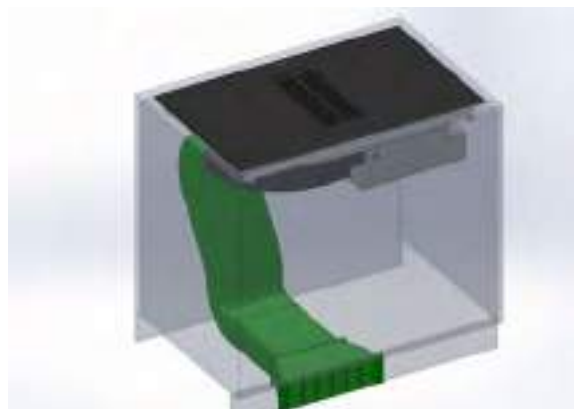

9700 580

Kit completo di canalizzazione filtrante per zoccolo H10/15 cm con mascherina in acciaio inox.

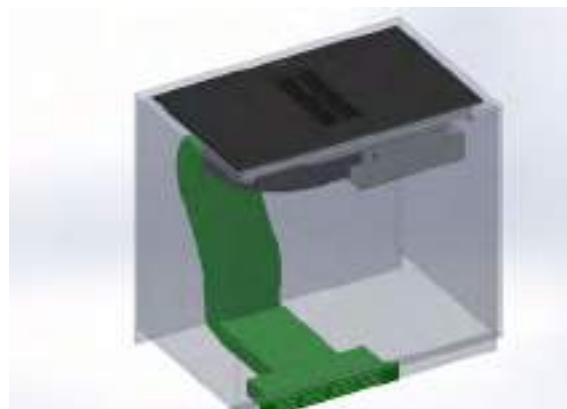

9700 577

Kit completo di canalizzazione filtrante per zoccolo H6/8 cm con mascherina in acciaio inox.

Accessori canalizzazione piani aspiranti e cappe

Sistema di canalizzazione Salvaspazio a sezione rettangolare



9700 532

tubo bianco
a sez. rettangolare 222x89 mm

dim: 222x89x1000 mm



9700 533

connettore bianco
a sez. rettangolare 227x94 mm

dim: 227x94x80 mm



9700 534

connettore ad angolo 90° orizz.
sez. rettangolare: 227x94 mm

dim: 288x288x94 mm



9700 535

connettore ad angolo 90° vert.
sez. rettangolare: 227x94 mm

dim: 174x174x227 mm



9700 536

connettore ad angolo 15° orizz.
sez. rettangolare: 227x94 mm

dim: 233x138x94 mm



9700 537

riduzione rett / tondo
sez. 227x94 mm / ø 158 mm

dim: 190x 150x227 mm



9700 538

valvola di non ritorno ø 148 mm



9700 539 *

griglia per zoccolo colore grigio
per zoccoli 100/150 mm

dim: 273x150 mm

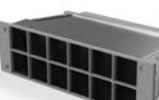

9700 574 *

filtro carbone per zoccolo
100-150 mm



9700 575 *

ricarica carbone attivo per filtro
zoccolo

* solo per piano aspirante e cappe Ghost.



KE Induction

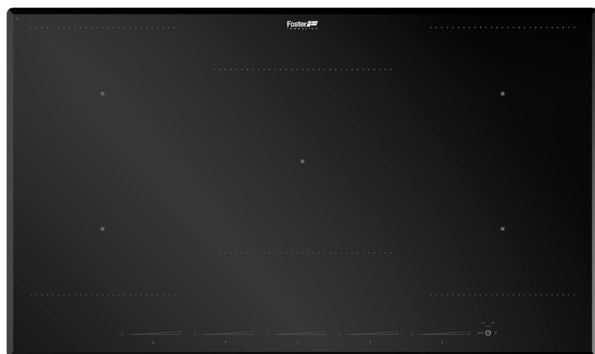

KE Induction

Codice	Versione	Caratteristiche	Prezzo
--------	----------	-----------------	--------



7384 646	 SF	incasso SF: 840 x 480	
	 FT	incasso FT: vedi sito web	

- Dimensioni: 860 x 510
- Finitura: Vetroceramica nero
- Programmazione elettronica;
- 5 zone cottura di cui 4 con funzione Bridge
- 9 settaggi di potenza per zona più funzione Powerboost

P. max assorbita 2.800, 3.500, 3.700, 4.500, 6.000, 7.400, **10.400 W****
 4 x 210x190 mm 2.100 (3.000)* W
 ø 250 mm 2.300 (3.000)* W

* Powerboost

Alimentazione: 230 - 380 V
50/60 Hz



Foro incasso
profondità 48 cm

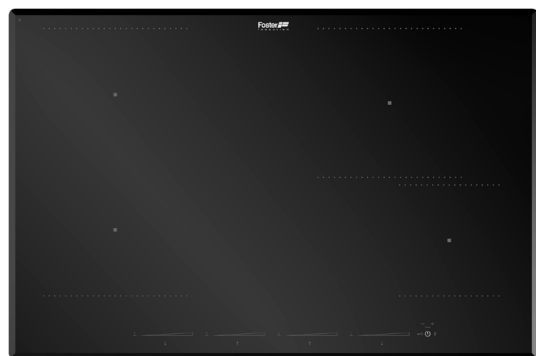

7382 646	 SF	incasso SF: 750 x 480	
	 FT	incasso FT: vedi sito web	

- Dimensioni: 770 x 510
- Finitura: Vetroceramica nero
- Programmazione elettronica;
- 4 zone cottura di cui 2 con funzione Bridge
- 9 settaggi di potenza per zona più funzione Powerboost

P. max assorbita 1.500, 2.800, 3.500, 3.700, 4.500, 6.000, **7.400 W****
 2 x 210x190 mm 2.100 (3.000)* W
 ø 200 mm 2.300 (3.000)* W
 ø 145 mm 1.400 (1.850)* W

* Powerboost

Alimentazione: 230 - 380 V
50/60 Hz



Foro incasso
profondità 48 cm

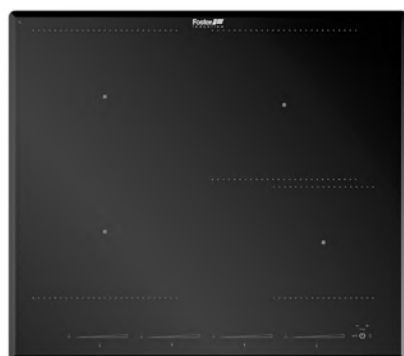

7381 646	 SF	incasso SF: 560 x 480	
	 FT	incasso FT: vedi sito web	

- Dimensioni: 580 x 510
- Finitura: Vetroceramica nero
- Programmazione elettronica;
- 4 zone cottura di cui 2 con funzione Bridge
- 9 settaggi di potenza per zona più funzione Powerboost

P. max assorbita 1.500, 2.800, 3.500, 3.700, 4.500, 6.000, **7.400 W****
 2 x 210x190 mm 2.100 (3.000)* W
 ø 200 mm 2.300 (3.000)* W
 ø 145 mm 1.400 (1.850)* W

* Powerboost

Alimentazione: 230 - 380 V
50/60 Hz



Foro incasso
profondità 48 cm



KE Induction

Codice

Versione

Caratteristiche

Prezzo



NEW

7385 646

SF

incasso SF: 870 x 370

FT

incasso FT: vedi sito web

- Dimensioni: 900 x 400
- Finitura: Vetroceramica nero
- Programmazione elettronica;
- 4 zone cottura con funzione Bridge
- 9 settaggi di potenza per zona più funzione Powerboost

P. max assorbita 2.800, 3.500, 3.700, 4.500, 6.000, **7.400 W****
4 x 210x190 mm 2.100 (3.000)* W

* Powerboost

Alimentazione: 230 - 380 V
50/60 Hz

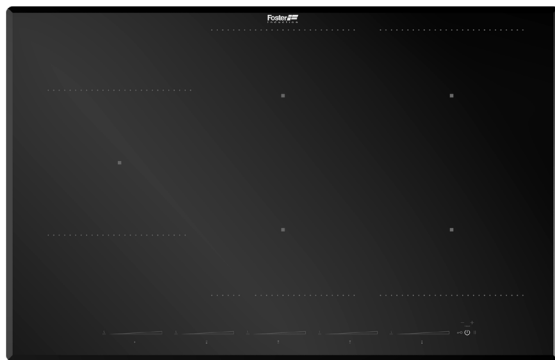

NEW

7386 646

SF

incasso SF: 750 x 480

FT

incasso FT: vedi sito web

- Dimensioni: 810 x 520
- Finitura: Vetroceramica nero
- Programmazione elettronica;
- 5 zone cottura di cui 4 con funzione Bridge
- 9 settaggi di potenza per zona più funzione Powerboost

P. max assorbita 2.800, 3.500, 3.700, 4.500, 6.000, 7.400, **10.400 W****
4 x 210x190 mm 2.100 (3.000)* W
Ø 200 2.300 (3.000)* W

* Powerboost

Alimentazione: 230 - 380 V
50/60 Hz



Foro incasso
profondità 48 cm





PIANI
INDUZIONE

S4000 Domino Line



7330 255

SF

incasso SF: 810 x 330

FT

incasso FT: vedi sito web

- Dimensioni: 840 x 350
- Finitura: Vetroceramica nero
- Programmazione elettronica;
- 9 settaggi di potenza per zona più funzione doppio Powerboost

P. max assorbita 7.400 w

2 zone con funzione bridge

sinistra \varnothing 260 mm 2.600 (3.600)* (3.700)** W

centro 180x220 mm 2.100 (2.600)* (3.700)** W

destra 180x220 mm 2.100 (2.600)* (3.700)** W

* Powerboost - ** Doppio Powerboost

Alimentazione: 230 - 380 V
50/60 Hz



S4000 Domino Line

Codice

Versione

Caratteristiche

Prezzo

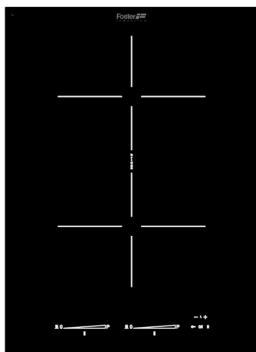

7341 655

Q4

incasso Q4: 350 x 490

FT

incasso FT: vedi sito web

- Dimensioni: 380 x 520
- Finitura: Vetroceramica nero
- Programmazione elettronica
- 9 settaggi di potenza per zona più funzione doppio Powerboost

P. max assorbita 3.700 W
2 zone con funzione Bridge
180x220 mm 2.100 (2.600)* (3.700)** W

* Powerboost - ** doppio Powerboost

Alimentazione: 230 V
50/60 Hz

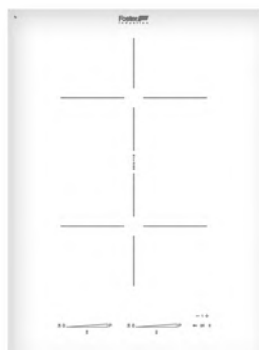

7341 255

Q4

incasso Q4: 350 x 490

FT

incasso FT: vedi sito web

- Dimensioni: 380 x 520
- Finitura: Vetroceramica bianco
- Programmazione elettronica
- 9 settaggi di potenza per zona più funzione doppio Powerboost

P. max assorbita 3.700 W
2 zone con funzione Bridge
180x220 mm 2.100 (2.600)* (3.700)** W

* Powerboost - ** doppio Powerboost

Alimentazione: 230 V
50/60 Hz



Teppan



7325 455

Q4

incasso Q4: 360 x 490

- Dimensioni: 380 x 520
- Finitura: Superficie in acciaio
- 2 zone cottura indipendenti A e B
- 9 livelli di potenza per zona
- Controllo elettronico della temperatura da 50° a 220° C
- Temperatura pre-impostate per: cottura carne, cottura pesce, pulizia

P. max assorbita 2.800 W
2 zone cottura 2 x 1.400 W

Alimentazione: 230 V
50/60 Hz



S4000 Domino Line

Codice

Versione

Caratteristiche

Prezzo



7321 240

Q4

incasso Q4: 350 x 490

FT

incasso FT: vedi sito web

- Dimensioni: 380 x 520
- Finitura: Vetroceramica nero
- Programmazione elettronica
- 9 settaggi di potenza per zona più funzione Powerboost

P. max assorbita 3.000 W
zona cottura ø 250 mm 2.300 (3.000)*

* Powerboost

Alimentazione: 230 V
50/60 Hz



7322 240

Q4

incasso Q4: 350 x 490

FT

incasso FT: vedi sito web

- Dimensioni: 380 x 520
- Finitura: Vetroceramica nero
- Programmazione elettronica
- 9 settaggi di potenza per zona più funzione Powerboost

P. max assorbita 3.700 W
superiore ø 200 mm 2.300 (3.000)*
inferiore ø 160 mm 1.200 (1.400)*

* Powerboost

Alimentazione: 230 V
50/60 Hz



Distanziere per piani Domino

8320 000



- Acciaio inox
- Dimensioni: **30x520** spessore: **4 mm**

Il distanziere in acciaio inox permette di creare un'unica superficie con i piani cottura domino aventi bordo verticale.

Il distanziere permette di aumentare lo spazio tra gli elementi della serie Domino e creare una pratica superficie d'appoggio.



Note per l'installazione in soluzione modulare continua



Installazione con fori d'incasso distinti

Per la corretta installazione in continuo va mantenuta una distanza di 20 mm tra i incassi dei prodotti (con eccezione di una distanza di 18 mm tra incasso cappa e altro prodotto). Per assicurare l'allineamento verticale dei prodotti si consiglia una profondità dell'incasso unica di 500 mm, indipendentemente dalla misura richiamata nel libretto (480, 490, 500 mm a seconda dei modelli).

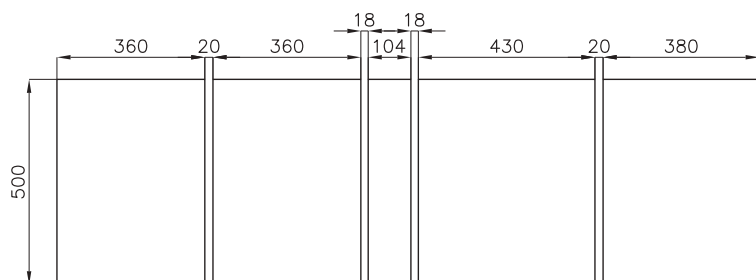

Installazione con unico foro d'incasso mediante l'utilizzo del distanziere

Con l'utilizzo dei distanzieri è possibile installare i prodotti in un unico foro da incasso, di 500 mm in profondità e in lunghezza pari alla somma delle dimensioni dei prodotti e dei distanzieri, diminuita di 20 mm. Nell'esempio riportato, da SX: $(380+30+380+30+120+30+450+30+400)$ mm-20 mm=1830 mm.

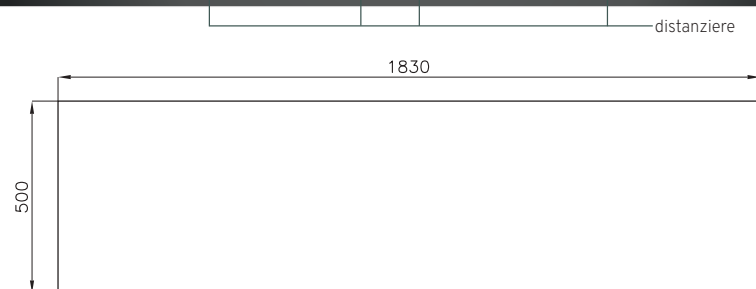

S4000 Domino si configura come incasso Q4, tuttavia, per vincoli progettuali, alcuni modelli hanno uno spessore leggermente maggiore. Questo comporta un piccolo scalino tra i prodotti nel caso di installazione in continuo: Teppan e cappa. Fare riferimento ai disegni dei singoli modelli, che riportano l'esatto spessore.

S1000



NEW

7374 300



incasso Q4: 810 x 330

incasso FT: vedi sito web

- Dimensioni: 840 x 350
- Finitura: Vetroceramica nero
- Programmazione elettronica
- 9 settaggi di potenza per zona più funzione Powerboost

P. max assorbita 2.800, 3.500, 6.000, 6.600** W
 sinistra \varnothing 240 mm 2.200 (3.000)*
 centro \varnothing 145 mm 1.200 (1.600)*
 destra \varnothing 210 mm 1.500 (2.000)*

* Powerboost



Alimentazione: 230 - 380 V
50/60 Hz



7371 300



incasso Q4: 740 x 480

incasso FT: vedi sito web

- Dimensioni: 770 x 510
- Finitura: Vetroceramica nero
- Programmazione elettronica
- 9 settaggi di potenza per zona più funzione Powerboost

P. max assorbita 2.800, 3.500, 6.000, **7.200**W**
 sinistra \varnothing 210 mm 1.500 (2.000)*
 sinistra sup. \varnothing 145 mm 1.200 (1.600)*
 destra \varnothing 145 mm 1.200 (1.600)*
 destra sup. \varnothing 210 mm 1.500 (2.000)*

* Powerboost



Alimentazione: 230 - 380 V
50/60 Hz



Foro incasso
profondità 48 cm

S1000

Codice

Versione

Caratteristiche

Prezzo



7370 300

 **Q4**

incasso Q4: 560 x 480

 **FT**

incasso FT: vedi sito web

- Dimensioni: 580 x 510
- Finitura: Vetrocera mica nero
- Programmazione elettronica
- 9 settaggi di potenza per zona più funzione Powerboost

P. max assorbita 2.800, 3.500, 6.000, **7.200**W**
 sinistra \varnothing 210 mm 1.500 (2.000)*
 sinistra sup. \varnothing 145 mm 1.200 (1.600)*
 destra \varnothing 145 mm 1.200 (1.600)*
 destra sup. \varnothing 210 mm 1.500 (2.000)*

* Powerboost



Alimentazione: 230 - 380 V
50/60 Hz



Foro incasso
profondità 48 cm



7373 300

 **Q4**

incasso Q4: 420 x 485

 **FT**

incasso FT: vedi sito web

- Dimensioni: 440 x 500
- Finitura: Vetrocera mica nero
- Programmazione elettronica
- 9 settaggi di potenza per zona più funzione Powerboost

P. max assorbita 1.500, 2.200, 2.800, 3.400, **5.200 W**
 sinistra sup. \varnothing 145 mm 1.200 (1.600)*
 sinistra inf. \varnothing 210 mm 1.500 (2.000)*
 destra \varnothing 145 mm 1.200 (1.600)*

* Powerboost



Alimentazione: 230 - 380 V
50/60 Hz



7322 300

 **Q4**

incasso Q4: 270 x 490

 **FT**

incasso FT: vedi sito web

- Dimensioni: 290 x 510
- Finitura: Vetrocera mica nero
- Programmazione elettronica
- 9 settaggi di potenza per zona più funzione Powerboost

P. max assorbita **3.700 W**
 superiore \varnothing 200 mm 2.300 (3.000)*
 inferiore \varnothing 160 mm 1.400

* Powerboost



Alimentazione: 230 - 380 V
50/60 Hz

Serie Modular Induction & Modular Quadra



Connessione del sistema Modular

Disposizione degli elementi

Il sistema Modular permette la libera disposizione dei suoi elementi. L'unico limite è dato dalla lunghezza dei cavi che collegano gli elementi con il box di connessione: **60 cm per il modulo touch e 90 cm per le zone di cottura.**

Combinazioni zone cottura

Il piano può essere composto in piena libertà; alcune combinazioni di piastre non compatibili sono segnalate tra le note dei Moduli Touch control.

Box di connessione

L'installazione è immediata e intuitiva. Il box può essere posto a muro dietro al cabinet o all'interno di esso, sotto al piano cottura.

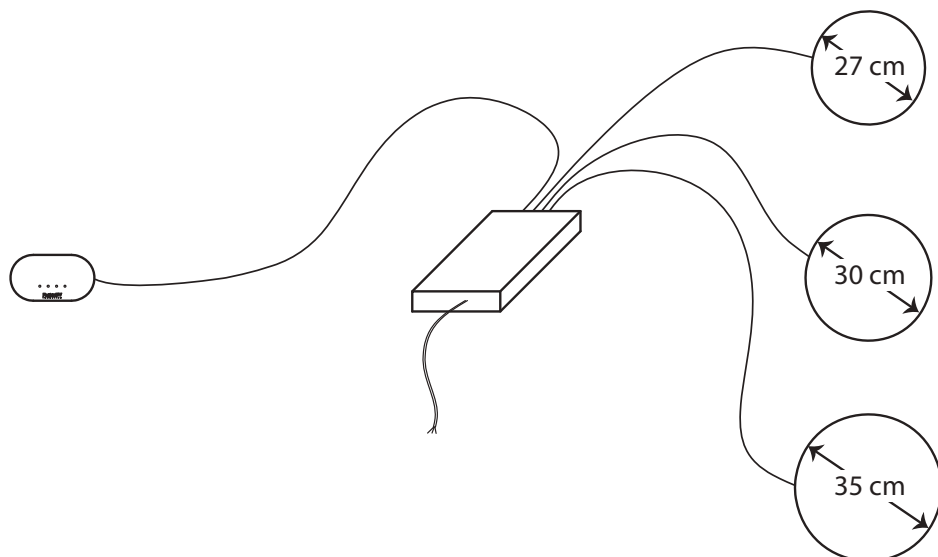

Serie Modular Induction & Modular Quadra

Massima libertà

Modular Induction è la nuova proposta Foster che vi permette la piena libertà di comporre il vostro piano ad induzione in base allo spazio disponibile e alle specifiche esigenze.

Infinite possibilità

I tre modelli di piastra, differenti per diametro e potenza, possono essere posizionati con grande flessibilità in combinazioni di due, tre o quattro zone controllate dai rispettivi pannelli touch control.

Installazione intuitiva

L'installazione è semplice e immediata grazie al box di connessione, facilmente posizionabile nel sottopiano, che collega le piastre al touch control.

Coordinato al vostro stile

Modular Induction, disponibile con design tondo o quadrato si adatta perfettamente allo stile della vostra cucina.



Serie Modular Induction



- Pannello Touch control
- Programmazione elettronica indipendente delle zone di cottura
- 9 settaggi di potenza per zona più funzione Powerboost

Da ordinare con relativo box di connessione

Nota: il Touch control Modular necessita di una semplice configurazione, in funzione della combinazione di piastre associate, come indicato nel manuale di installazione.

Alimentazione: 230 - 380 V
50/60 Hz



Serie Modular Induction

Codice

Versione

Caratteristiche

Prezzo

Touch control per 4 zone



Dimensioni: 275 x 150 R75

7368 040

Q4

Incasso Q4: vedi sito web

+ box di
connessione

FT

Incasso FT: vedi sito web

7369 040

Combinazioni zone cottura collegabili:

- 2 zone 7361 270

- 2 zone libere (qualsiasi modello)

Touch control per 3 zone



Dimensioni: 275 x 150 R75

7368 030

Q4

Incasso Q4: vedi sito web

+ box di
connessione

FT

Incasso FT: vedi sito web

7369 030

Combinazioni zone cottura collegabili:

- 1 zona 7361 270

- 2 zone libere (qualsiasi modello)

Touch control per 2 zone



Dimensioni: 275 x 150 R75

7368 020

Q4

Incasso Q4: vedi sito web

+ box di
connessione

FT

Incasso FT: vedi sito web

7369 020

Combinazioni zone cottura collegabili:

- 2 zone libere (qualsiasi modello)

Zona induzione Ø 350 mm

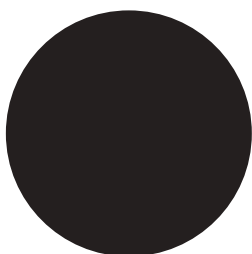

7363 350

Q4

Incasso Q4: Ø 334

FT

Incasso FT: vedi sito web

P. max assorbita
2.300 (3.000)* W
* Powerboost

Zona induzione Ø 300 mm

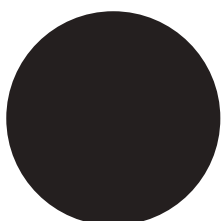

7362 300

Q4

Incasso Q4: Ø 284

FT

Incasso FT: vedi sito web

P. max assorbita
2.300 (3.000)* W
* Powerboost

Zona induzione Ø 270 mm

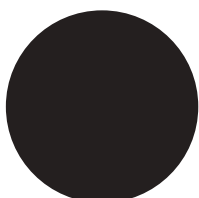

7361 270

Q4

Incasso Q4: Ø 254

FT

Incasso FT: vedi sito web

P. max assorbita
1.100 (1.400)* W
* Powerboost

Serie Modular Quadra



- Pannello Touch control
- Programmazione elettronica indipendente delle zone di cottura
- 9 settaggi di potenza per zona più funzione Powerboost

Da ordinare con relativo box di connessione

Nota: il Touch control Modular necessita di una semplice configurazione, in funzione della combinazione di piastre associate, come indicato nel manuale di installazione.

Alimentazione: 230 - 380 V
50/60 Hz



Serie Modular Quadra

Codice

Versione

Caratteristiche

Prezzo

Touch control per 4 zone



Dimensioni: 275 x 150 R5

7367 040



Incasso SF: 265 x 140

+ box di
connessione



Incasso FT: vedi sito web

7369 040

Combinazioni zone cottura collegabili:

- 2 zone 7364 270

- 2 zone libere (qualsiasi modello)

Touch control per 3 zone



Dimensioni: 275 x 150 R5

7367 030



Incasso SF: 265 x 140

+ box di
connessione



Incasso FT: vedi sito web

7369 030

Combinazioni zone cottura collegabili:

- 1 zona 7364 270

- 2 zone libere (qualsiasi modello)

Touch control per 2 zone



Dimensioni: 275 x 150 R5

7367 020



Incasso SF: 265 x 140

+ box di
connessione



Incasso FT: vedi sito web

7369 020

Combinazioni zone cottura collegabili:

- 2 zone libere (qualsiasi modello)

Zona induzione 350 x 350 mm



7366 350



Incasso SF: 334 x 334

Foro incasso:
vedi sito web



Incasso FT: vedi sito web

P. max assorbita
2.300 (3.000)* W
* Powerboost

Zona induzione 300 x 300 mm



7365 300



Incasso SF: 284 x 284

Foro incasso:
vedi sito web



Incasso FT: vedi sito web

P. max assorbita
2.300 (3.000)* W
* Powerboost

Zona induzione 270 x 270 mm



7364 270



Incasso SF: 254 x 254

Foro incasso:
vedi sito web



Incasso FT: vedi sito web

P. max assorbita
1.100 (1.400)* W
* Powerboost

Configurazioni Serie Modular Induction

Codice

Prezzo

Gli articoli sotto riportati rappresentano alcune nostre proposte già configurate, e non escludono la possibilità di altre combinazioni di piastre.

La disposizione degli elementi sul top rimane libera, con i vincoli riportati alla sezione "Connessione del Sistema Modular Induction" (Pag. 384).

4 zone



1 Touch control
1 box di connessione
2 zone Ø 300 mm
2 zone Ø 270 mm

7366 040

3 zone

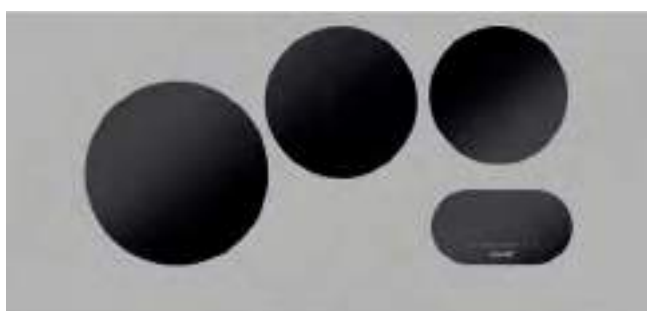

1 Touch control
1 box di connessione
1 zona Ø 350 mm
1 zona Ø 300 mm
1 zona Ø 270 mm

7366 030

2 zone



1 Touch control
1 box di connessione
1 zona Ø 350 mm
1 zona Ø 270 mm

7366 020



Configurazioni Serie Modular Quadra

Codice

Prezzo

Gli articoli sotto riportati rappresentano alcune nostre proposte già configurate, e non escludono la possibilità di altre combinazioni di piastre. La disposizione degli elementi sul top rimane libera, con i vincoli riportati alla sezione "Connessione del Sistema Modular Induction" (Pag. 384).

4 zone

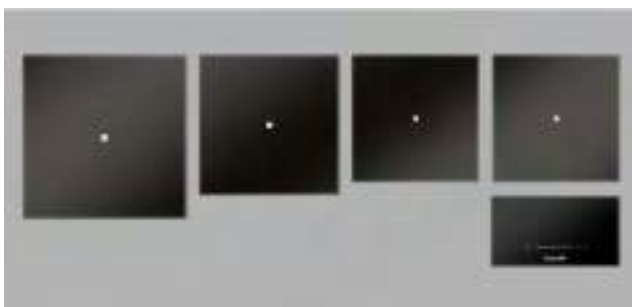

1 Touch control
1 box di connessione
1 zona 300 x 300 mm
2 zone 270 x 270 mm
1 zona 350 x 350 mm

7365 040

3 zone



1 Touch control
1 box di connessione
1 zona 350 x 350 mm
1 zona 300 x 300 mm
1 zona 270 x 270 mm

7365 030

2 zone



1 Touch control
1 box di connessione
1 zona 350 x 350 mm
1 zona 270 x 350 mm

7365 020



KE Arya Black **NEW**

7392 246

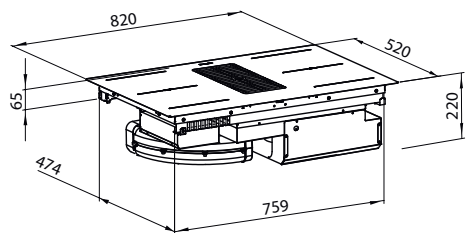

Foster Milano Air

7391 245

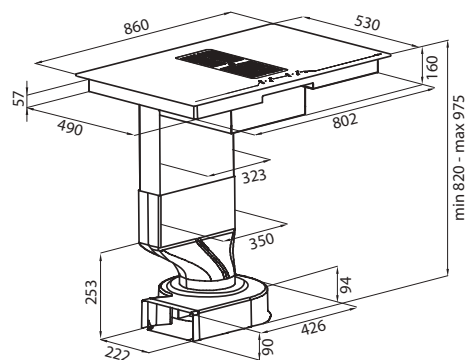

KE Induction

7384 646

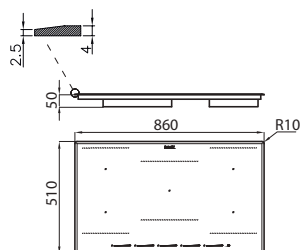

7382 646

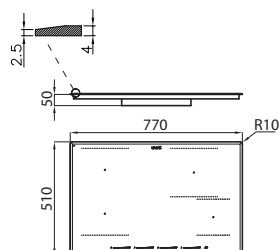

7381 646

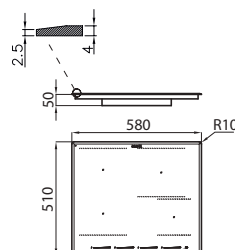

7385 646 **NEW**

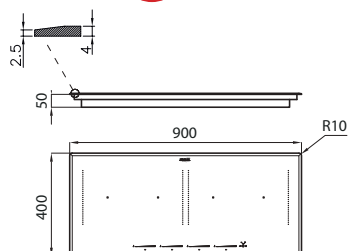

7386 646 **NEW**

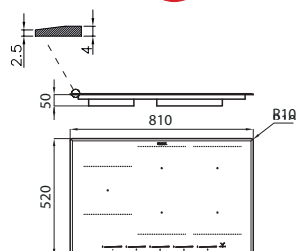

S4000 Domino Line

7330 255

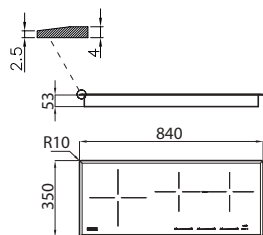

7341 655

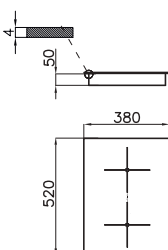

7341 255

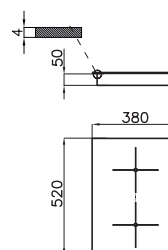

7325 455

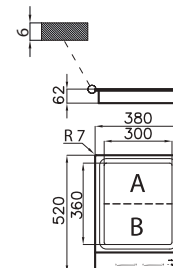

S4000 Domino Line

7321 240

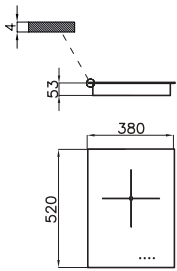

7322 240

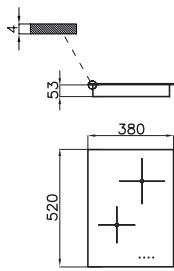

S1000

7374 300

NEW

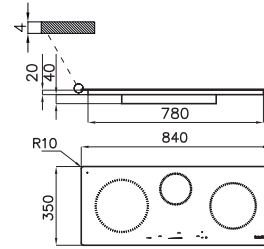

7371 300

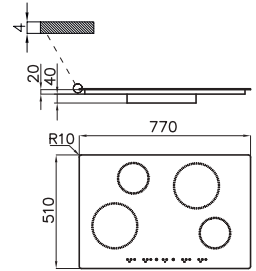

S1000

7370 300

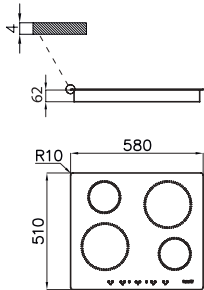

7373 300

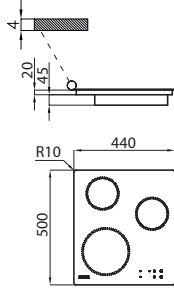

7322 300

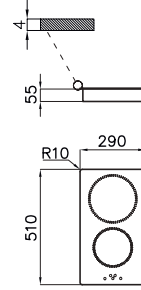

Serie Modular Induction

7368 040
7368 030
7368 020

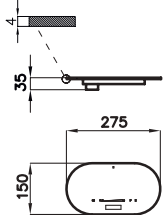

7369 040
7369 030
7369 020

Box di connessione

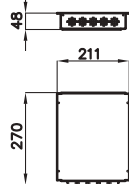

7363 350

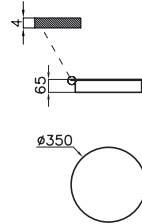

7362 300

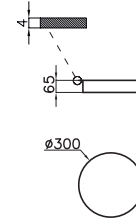

7361 270

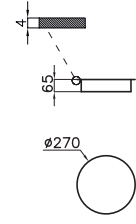

PIANI
INDUZIONE

Serie Modular Quadra

7367 040
7367 030
7367 020

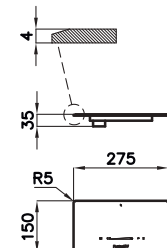

7369 040
7369 030
7369 020

Box di connessione

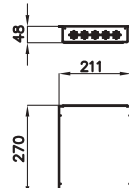

7366 350

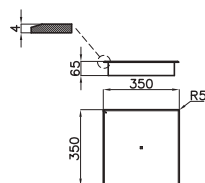

7365 300

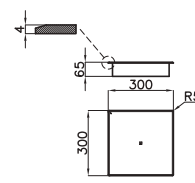

7364 270

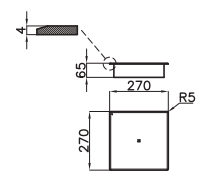

Piani cottura gas





PIANI GAS







FF121

Footer

Foot

□ □ □ □ □

402	Milanello 5F
404	Milanello
406	Milano 
408	S4000
410	S4000 Domino
412	S4000 Line
414	Quadra Angolare
416	FL
418	KE
421	KF 
422	Veronika
424	Angolare
426	Power 
428	Power Glass 



Piani cottura **Gas**

Natura / Tecnologia

Risparmio energetico
con massima efficienza

Massima sicurezza
grazie a valvole di sicurezza

che interrompono l'erogazione del gas in caso di accidentale spegnimento della fiamma

Bruciatori performanti
che garantiscono un notevole risparmio energetico



Bruciatori Alta Efficienza (AEO):
5 kW e risparmio del 25% di gas

I nuovi bruciatori AEO (alta efficienza) hanno un rendimento massimo del 69%, il bruciatore DUAL AEO raggiunge la potenza massima di 5 kW. L'anello spartifiamma in ottone, contribuisce a conferire l'aspetto professionale.



Bruciatori III^A serie:
risparmio 20% di gas

Garantiscono un'efficienza ben superiore agli standard europei. Il sistema bloccante tra coperchio e spartifiamma garantisce il perfetto posizionamento e maggiore praticità nella pulizia.



Bruciatori Dual:
prestazioni e versatilità. da 300 a 4.500 W

Innovativo e versatile bruciatore, con tre corone di fuoco ad accensione indipendente azionate da un'unica manopola. È in grado di erogare potenze da 300 a 4500 W.



Bruciatori Flat

Efficienza superiore agli standard con estetica ultrapiatta.

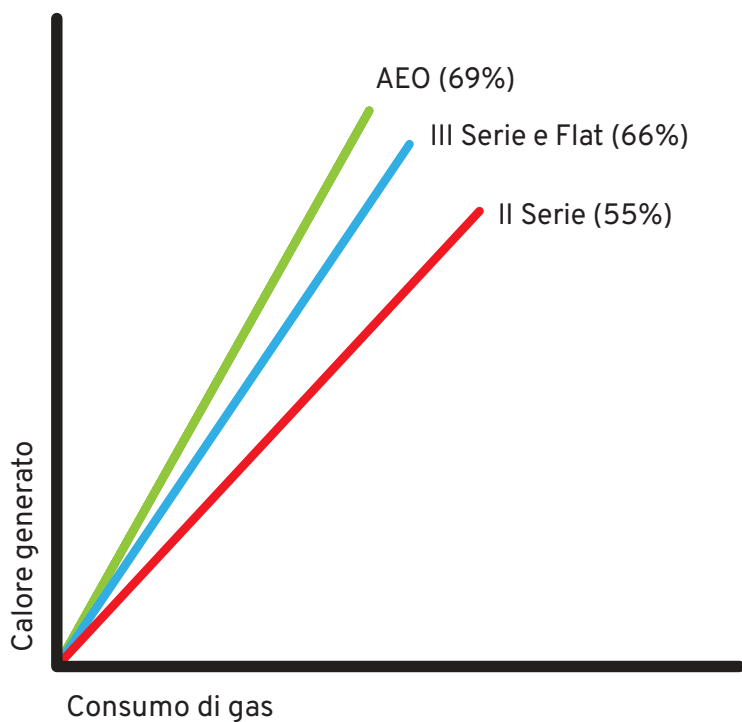

La versatilità dei bruciatori Dual
Massima funzionalità grazie alle tre corone di fuoco.



Griglie in ghisa



Alta capacità termica
che migliora il rendimento

Robustezza e stabilità
che migliorano la sicurezza

Eleganti per la loro linearità
e in dotazione standard su ogni piano cottura

Piani cottura Gas



Ultrapiatti

Le griglie formano una superficie che permette di spostare le pentole da un fuoco all'altro.

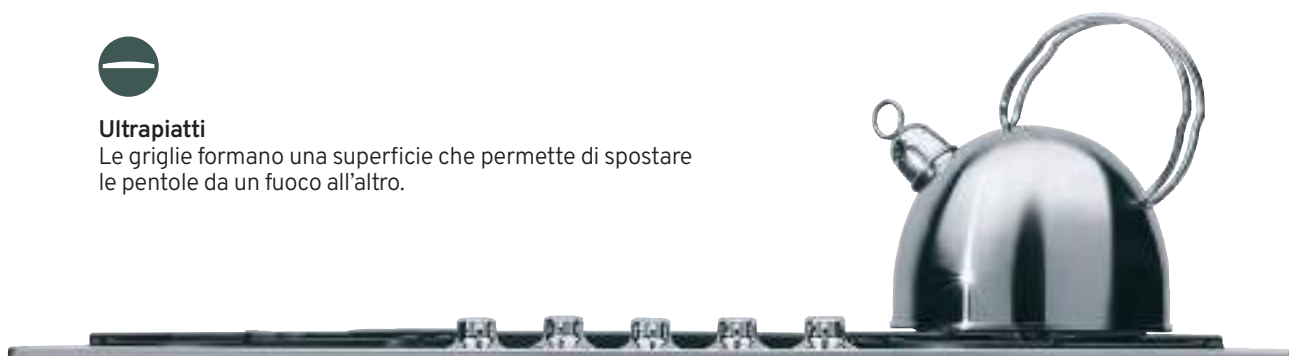

Invaso profondo

La profondità dell'invaso migliora la robustezza e la professionalità del piano garantendo comunque una facile pulizia anche negli spigoli.



Precise Power

Massima precisione nella regolazione della fiamma, grazie ai 10 livelli predefiniti del sistema Precise Power



Superficie in ghisa

Il piano è dotato di accessori in ghisa che ne aumentano la superficie di appoggio.



Manopola in metallo

La robusta manopola in metallo oltre a rendere professionale il piano gli dona eleganza e funzionalità.



Griglia XXL

La griglia XXL ha dimensioni straordinarie che permette un'ampia superficie di appoggio anche per pentole di grandi dimensioni.

Piani cottura **Gas** | Caratteristiche

Oltre l'incasso... come e dove vuoi tu

Foster offre una notevole e completa gamma di sistemi di inserimento.



STD

Standard

Tipo di incasso tradizionale con il bordo che sporge di 8 mm sul piano di lavoro.

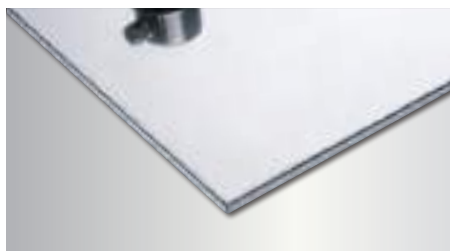

Q4

Q4

Incasso con profilo squadrato ed una sporgenza dal piano di soli 4 mm.



SF

Semifilo

Bordo inclinato che sporge solo 3 mm sul top. Eleganza e facilità di installazione.



FT SPT

Filotop

Si inserisce in un ribasso del top e risulta perfettamente a filo. In alternativa, può essere installato in appoggio.

Tutti i piani cottura Foster sono collaudati a gas metano e sono presenti in dotazione gli ugelli per il gas GPL.

Allacciamento rete elettrica

Tutti i piani cottura a gas Foster sono predisposti per il collegamento 220-240V 50/60 Hz.

Piani cottura **Gas** | Accessori



1 Porta wok
9601 668



2 Porta wok
9601 727



3 Placca in ghisa
9601 742







4 Placca in ghisa
9601 741

Milanello 5F

sopratop | filotop



Accessori: **2** (vedi pag. 401)

Codice	Versione	Caratteristiche	Prezzo
7682 000	 FT	incasso FT: vedi sito web	
	 SPT	incasso SPT: 790x500	
<ul style="list-style-type: none"> • AISI 304 satinato • Dimensioni: 803 x 513 • Griglie in ghisa e coprispartifiamma smaltati • Accensione elettrica • Valvolatura di sicurezza 		<ul style="list-style-type: none"> • Potenza tot. 10.250 W ausiliario: 1.000 W semirapido: 3x1.750 W doppia corona: 4.000 W 	
<ul style="list-style-type: none"> • Disponibile anche in versione PVD 		Gun Metal 7682 006  pag. 40	Copper 7682 008  pag. 58
		Gold 7682 009  pag. 76	

Precise Power:
Grande controllo nella regolazione

- 10 livelli di potenza
- Massima precisione nelle regolazioni della fiamma
- Estetica ultra-piatta

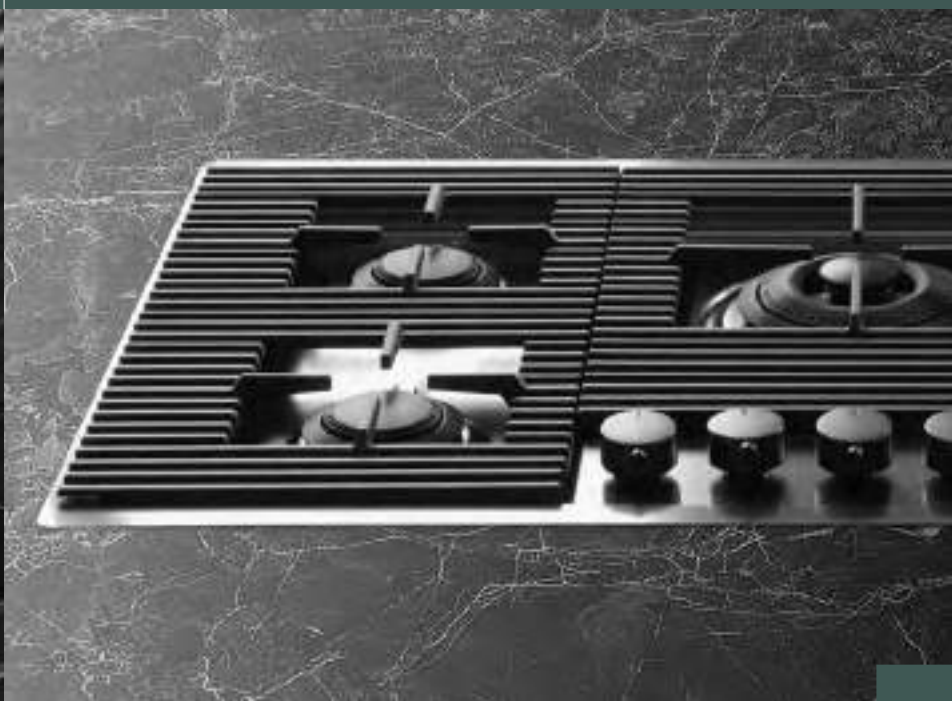

Milanello
sopratop | filotop



Milanello

sopratop | filotop



Accessori: 2 (vedi pag. 401)

Codice	Versione	Caratteristiche	Prezzo
--------	----------	-----------------	--------

- | | | | |
|-----------------|------------|---------------------------|--|
| 7681 000 | FT | incasso FT: vedi sito web | |
| | SPT | incasso SPT: 1098X459 | |
- AISI 304 satinato
 - Dimensioni: **1115 x 476**
 - Griglie in ghisa e coprispartifiamma smaltati
 - Accensione elettrica
 - Valvolatura di sicurezza con termocoppia ad intervento rapido
 - Potenza tot. 10.750 W
ausiliario: 1.000 W
semirapido: 1.750 W
rapido: 3.000 W
dual: 5.000 W

• Disponibile anche in versione PVD	Gun Metal 7681 006	Copper 7681 008	Gold 7681 009
	pag. 40	pag. 58	pag. 76

- | | | | |
|-----------------|------------|---------------------------|--|
| 7680 000 | FT | incasso FT: vedi sito web | |
| | SPT | incasso SPT: 853x459 | |



Accessori: 2 (vedi pag. 401)

- AISI 304 satinato
- Dimensioni: **870 x 476**
- Griglie in ghisa e coprispartifiamma smaltati
- Accensione elettrica
- Valvolatura di sicurezza con termocoppia ad intervento rapido
- Potenza tot. 7.750 W
ausiliario: 1.000 W
semirapido: 1.750 W
dual: 5.000 W

• Disponibile anche in versione PVD	Gun Metal 7680 006	Copper 7680 008	Gold 7680 009
	pag. 40	pag. 58	pag. 76



Milano **NEW**
sopratop | filotop



In dotazione: 2x **2** (vedi pag. 401)

Codice	Versione	Caratteristiche	Prezzo
--------	----------	-----------------	--------

7639 000

FT

incasso FT: vedi sito web

SPT

incasso SPT: 1134x540

- AISI 304 satinato
- Dimensioni: **1154x560**
- Griglie in ghisa e coprispartifiamma smaltati
- Accensione elettrica
- Valvolatura di sicurezza

- Potenza tot. 15.900 W
- ausiliario: 1.000 W
- semirapido: 2x1.750 W
- rapido: 3.000 W
- dual: 2x4.200 W

• Disponibile anche in versione **PVD**

Gun Metal
7639 006



pag. 41

Copper
7639 008



pag. 59

Gold
7639 009



pag. 77

Codice	Versione	Caratteristiche	Prezzo
--------	----------	-----------------	--------



In dotazione: **2** (vedi pag. 401)

7638 000	FT	incasso FT: vedi sito web
	SPT	incasso SPT: 1036x540

- AISI 304 satinato
- Dimensioni: **1056x560**
- Griglie in ghisa e coprispartifiamma smaltati
- Accensione elettrica
- Valvolatura di sicurezza
- Potenza tot. 10.950 W
ausiliario: 2x1.000 W
semirapido: 1.750 W
rapido: 3.000 W
dual: 4.200 W

• Disponibile anche in versione **PVD**

Gun Metal
7638 006



pag. 41

Copper
7638 008



pag. 59

Gold
7638 009



pag. 77



In dotazione: **2** (vedi pag. 401)

7637 000	FT	incasso FT: vedi sito web
	SPT	incasso SPT: 800x540

- AISI 304 satinato
- Dimensioni: **820x560**
- Griglie in ghisa e coprispartifiamma smaltati
- Accensione elettrica
- Valvolatura di sicurezza
- Potenza tot. 9.950 W
ausiliario: 1.000 W
semirapido: 1.750 W
rapido: 3.000 W
dual: 4.200 W



In dotazione: **2** (vedi pag. 401)

7640 000	FT	incasso FT: vedi sito web
	SPT	incasso SPT: 1060x470

- AISI 304 satinato
- Dimensioni: **1080x490**
- Griglie in ghisa e coprispartifiamma smaltati
- Accensione elettrica
- Valvolatura di sicurezza
- Potenza tot. 9.950 W
ausiliario: 1.000 W
semirapido: 1.750 W
rapido: 3.000 W
dual: 4.200 W

• Disponibile anche in versione **PVD**

Gun Metal
7640 006



pag. 41

Copper
7640 008



pag. 59

Gold
7640 009



pag. 77

S4000

sopratop | filotop | Q4



S4000

sopratop | filotop

Codice	Versione	Caratteristiche	Prezzo
--------	----------	-----------------	--------

7257 032	 FT	incasso FT: vedi sito web	
	 SPT	incasso SPT: 900x500	



In dotazione: **1** | Accessori Filotop: **3** (vedi pag. 401)

- AISI 304 satinato
- Dimensioni: **920x520**
- Griglie in ghisa e coprispartifiamma smaltati
- Accensione elettrica
- Valvolatura di sicurezza con termocoppia ad intervento rapido

- Potenza tot. 11.400 W
ausiliario: 1.100 W
semirapido: 2x1.750 W
rapido: 3.000 W
tripla corona: 3.800 W



7271 032	 FT	incasso FT: vedi sito web	
	 SPT	incasso SPT: 900x500	



In dotazione: **1** | Accessori Filotop: **3** (vedi pag. 401)

- AISI 304 satinato
- Dimensioni: **920x520**
- Griglie in ghisa e coprispartifiamma smaltati
- Accensione elettrica
- Valvolatura di sicurezza con termocoppia ad intervento rapido

- Potenza tot. 11.400 W
ausiliario: 1.100 W
semirapido: 2x1.750 W
rapido: 3.000 W
tripla corona: 3.800 W

7256 032	 FT	incasso FT: vedi sito web	
	 SPT	incasso SPT: 600x500	



Accessori Filotop: **3** (vedi pag. 401)

- AISI 304 satinato
- Dimensioni: **620x520**
- Griglie in ghisa e coprispartifiamma smaltati
- Accensione elettrica
- Valvolatura di sicurezza con termocoppia ad intervento rapido

- Potenza tot. 7.600 W
ausiliario: 1.100 W
semirapido: 2x1.750 W
rapido: 3.000 W

S4000 Domino

Q4

Codice

Versione

Caratteristiche

Prezzo

7278 032

 **04**

incasso: 430x480



- AISI 304 satinato
- Dimensioni: **450x520**
- Griglie in ghisa e coprispartifiamma smaltati
- Accensione elettrica
- Valvolatura di sicurezza con termocoppia ad intervento rapido
- Potenza tot. 5.000 W
dual AE: 5.000 W



In dotazione: **2**, **3** (vedi pag. 401)

Note per il fissaggio nella pagina a fianco

Predisposizione per i mercati asiatici su richiesta

7276 032

 **04**

incasso: 360x480



- AISI 304 satinato
- Dimensioni: **380x520**
- Griglie in ghisa e coprispartifiamma smaltati
- Accensione elettrica
- Valvolatura di sicurezza con termocoppia ad intervento rapido
- Potenza tot. 2.750 W
ausiliario AE: 1.000 W
semirapido AE: 1.750 W



In dotazione: **3** (vedi pag. 401)

Note per il fissaggio nella pagina a fianco

Un appoggia pentola versatile



Nelle versioni con incasso filotop, è disponibile come elemento accessorio la piastra porta-pentole cod. 9601742, che moltiplica la superficie di lavoro, salvaguardando il top dal contatto accidentale con le pentole calde.

Di serie per le versioni S4000 Domino.



Distanziere per piani Domino

8320 000



- Acciaio inox
- Dimensioni: **30x520** spessore: **4 mm**

Il distanziere in acciaio inox permette di creare un'unica superficie con i piani cottura domino aventi bordo verticale.

Il distanziere permette di aumentare lo spazio tra gli elementi della serie Domino e creare una pratica superficie d'appoggio.



Note per l'installazione in soluzione modulare continua



Installazione con fori d'incasso distinti

Per la corretta installazione in continuo va mantenuta una distanza di 20 mm tra i incassi dei prodotti (con eccezione di una distanza di 18 mm tra incasso cappa e altro prodotto). Per assicurare l'allineamento verticale dei prodotti si consiglia una profondità dell'incasso unica di 500 mm, indipendentemente dalla misura richiamata nel libretto (480, 490, 500 mm a seconda dei modelli).

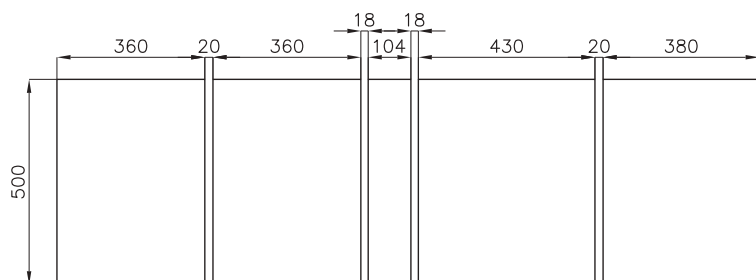

Installazione con unico foro d'incasso mediante l'utilizzo del distanziere

Con l'utilizzo dei distanzieri è possibile installare i prodotti in un unico foro da incasso, di 500 mm in profondità e in lunghezza pari alla somma delle dimensioni dei prodotti e dei distanzieri, diminuita di 20 mm. Nell'esempio riportato, da SX:
 $(380+30+380+30+120+30+450+30+400)$ mm-20 mm=1830 mm.

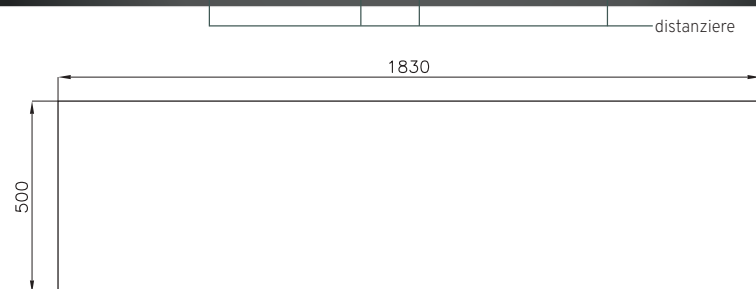



S4000 Domino si configura come incasso Q4, tuttavia, per vincoli progettuali, alcuni modelli hanno uno spessore leggermente maggiore. Questo comporta un piccolo scalino tra i prodotti nel caso di installazione in continuo: Teppan e cappa. Fare riferimento ai disegni dei singoli modelli, che riportano l'esatto spessore.

S4000 Line

sopratop | filotop



Codice	Versione	Caratteristiche	Prezzo
7284 042	 FT	incasso FT: vedi sito web	
	 SPT	incasso SPT: 1162x448	

- AISI 304 satinato
- Dimensioni: **1179x465**
- Griglie in ghisa e coprispartifiamma smaltati
- Accensione elettrica
- Valvolatura di sicurezza con termocoppia ad intervento rapido
- Potenza tot. 9.650 W
ausiliario: 1.100 W
semirapido: 1.750 W
rapido: 3.000 W
tripla corona: 3.800 W



In dotazione: 4x ,  (vedi pag. 401)

S4000 Line

sopratop | filotop



Codice	Versione	Caratteristiche	Prezzo
--------	----------	-----------------	--------

7285 032	 FT	incasso FT: vedi sito web	
	 SPT	incasso SPT: 908x448	





In dotazione: 3x  ,  (vedi pag. 401)



- AISI 304 satinato
- Dimensioni: **925x465**
- Griglie in ghisa e coprispartifiamma smaltati
- Accensione elettrica
- Valvolatura di sicurezza con termocoppia ad intervento rapido
- Potenza tot. 6.650 W ausiliario: 1.100 W semirapido: 1.750 W tripla corona: 3.800 W

7259 042	 FT	incasso FT: vedi sito web	
	 SPT	incasso SPT: 1162x351	





In dotazione:  | Accessori:  (vedi pag. 401)

- AISI 304 satinato
- Dimensioni: **1179x368**
- Griglie in ghisa e coprispartifiamma smaltati
- Accensione elettrica
- Valvolatura di sicurezza con termocoppia ad intervento rapido
- Potenza tot. 9.650 W ausiliario: 1.100 W semirapido: 1.750 W rapido: 3.000 W tripla corona: 3.800 W

7286 032	 FT	incasso FT: vedi sito web	
	 SPT	incasso SPT: 908x351	



In dotazione:  | Accessori:  (vedi pag. 401)



- AISI 304 satinato
- Dimensioni: **925x368**
- Griglie in ghisa e coprispartifiamma smaltati
- Accensione elettrica
- Valvolatura di sicurezza con termocoppia ad intervento rapido
- Potenza tot. 6.650 W ausiliario: 1.100 W semirapido: 1.750 W tripla corona: 3.800 W

Quadra Angolare

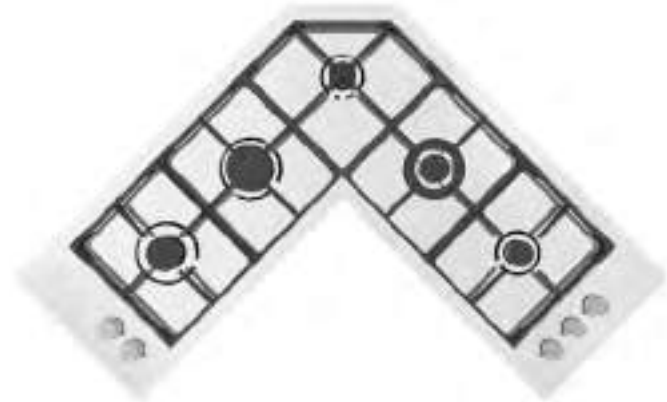
sopratop | filotop



In dotazione: **1** (vedi pag. 401)

Codice	Versione	Caratteristiche	Prezzo
7238 042	 FT	incasso FT: vedi sito web	
	 SPT	incasso SPT: vedi sito web	

- AISI 304 satinato
- Dimensioni: **972x972**
- Griglie in ghisa e coprispartifiamma smaltati
- Accensione elettrica
- Valvolatura di sicurezza con termocoppia ad intervento rapido
- Potenza tot. 9.950 W
ausiliario: 2x1.000 W
semirapido: 1.750 W
rapido: 2.700 W
tripla corona: 3.500 W

L'allacciamento alla rete del gas deve essere effettuato tramite i due ingressi ai tubi rampa delle manopole.







L'angolo intelligente

Con un'ampia superficie frontale di lavoro, il piano cottura Quadra Angolare consente di utilizzare al meglio l'angolo cucina.

FL
sopratop | filotop | standard



In dotazione: 2 (vedi pag. 401)

Codice	Versione	Caratteristiche	Prezzo
7201 032	 STD	Standard: 860x500 incasso: 840x480	
7206 032	 FT  SPT	Filotop: 873x513 incasso FT: vedi sito web incasso SPT: 860x500	
7206 082 Finitura vintage			

- AISI 304 satinato
- Griglie in ghisa e coprispartifiamma smaltati
- Valvolatura di sicurezza con termocoppia ad intervento rapido
- Accensione elettrica
- Potenza tot. 10.500 W
ausiliario: 2x1.000 W
dual AE: 5.000 W
semirapido: 2x1.750 W

FL

sopratop | filotop | standard

Codice	Versione	Caratteristiche	Prezzo
--------	----------	-----------------	--------

7203 032	 STD	incasso: 740x480	
-----------------	---	------------------	--



- AISI 304 satinato
 - Dimensioni: **760x500**
 - Griglie in ghisa e coprispartifiamma smaltati
 - Accensione elettrica
 - Valvolatura di sicurezza con termocoppia ad intervento rapido
- Potenza tot. 10.000 W
 - dual AE: 2x5.000 W



In dotazione: 2x  (vedi pag. 401)

7208 032	 FT	incasso FT: vedi sito web
-----------------	--	---------------------------

 SPT	incasso SPT: 340x500
---	----------------------



- AISI 304 satinato
 - Dimensioni: **353x513**
 - Griglie in ghisa e coprispartifiamma smaltati
 - Accensione elettrica
 - Valvolatura di sicurezza con termocoppia ad intervento rapido
- Potenza tot. 2.750W
 - ausiliario: 1.000 W
 - semi-rapido: 1.750 W



7207 032	 FT	incasso FT: vedi sito web
-----------------	--	---------------------------

 SPT	incasso SPT: 340x500
---	----------------------



- AISI 304 satinato
 - Dimensioni: **353x513**
 - Griglie in ghisa e coprispartifiamma smaltati
 - Accensione elettrica
 - Valvolatura di sicurezza con termocoppia ad intervento rapido
- Potenza tot. 5.000 W
 - dual AE: 5.000 W



In dotazione:  (vedi pag. 401)

KE

sopratop | filotop | standard



KE

sopratop | filotop | standard

Codice

Versione

Caratteristiche

Prezzo

7603 032

 **STD**

incasso: 840x480



- AISI 304 satinato
- Dimensioni: **860x500**
- Griglie in ghisa e coprispartifiamma smaltati
- Accensione elettrica
- Valvolatura di sicurezza con termocoppia ad intervento rapido

- Potenza tot. 9.500 W
ausiliario: 2x1.100 W
semirapido: 2x1.750 W
tripla corona: 3.800 W



Accessori: **2** (vedi pag. 401)

7602 032

 **STD**

incasso: 750x480*



- AISI 304 satinato
- Dimensioni: **790x500**
- Griglie in ghisa e coprispartifiamma smaltati
- Accensione elettrica
- Valvolatura di sicurezza con termocoppia ad intervento rapido

- Potenza tot. 9.500 W
ausiliario: 2x1.100 W
semirapido: 2x1.750 W
tripla corona: 3.800 W



Accessori: **2** (vedi pag. 401)

Possibilità di installazione su basi da 75 e top con spessore massimo 12mm.
Per un perfetto abbinamento vedi gli altri prodotti per basi e moduli da 75 a pagina 449

7600 032

 **SF**

incasso: 770x480



- AISI 304 satinato
- Dimensioni: **803x513**
- Griglie in ghisa e coprispartifiamma smaltati
- Accensione elettrica
- Valvolatura di sicurezza con termocoppia ad intervento rapido

- Potenza tot. 9.500 W
ausiliario: 2x1.100 W
semirapido: 2x1.750 W
tripla corona: 3.800 W



Accessori: **2** (vedi pag. 401)

KE

sopratop | filotop | standard

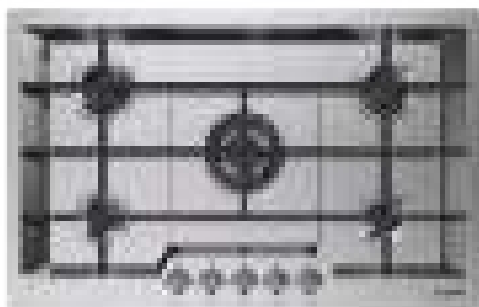

Accessori: **2** (vedi pag. 401)

Codice

Versione

Caratteristiche

Prezzo

7601 032

FT

incasso FT: vedi sito web

SPT

incasso SPT: 790x500

- AISI 304 satinato
- Dimensioni: **803x513**
- Griglie in ghisa e coprispartifiamma smaltati
- Accensione elettrica
- Valvolatura di sicurezza con termocoppia ad intervento rapido
- Potenza tot. 9.500 W
ausiliario: 2x1.100 W
semirapido: 2x1.750 W
tripla corona: 3.800

• Disponibile anche in versione **PVD**

Gun Metal
7601 632



pag. 42

Copper
7601 866



pag. 60

Gold
7601 932



pag. 78



KF **NEW**
standard



Modello non integrabile in top inox

Accessori: **2** (vedi pag. 401)

Codice

7666 062

Versione

STD

Caratteristiche

incasso: 560x480

Prezzo

- AISI 304 satinato
- Dimensioni: **760x500**
- Griglie in ghisa e coprispartifiamma smaltati
- Accensione elettrica
- Valvolatura di sicurezza con termocoppia ad intervento rapido

- Potenza tot. 10.700 W
- ausiliario: 1.000 W
- semirapido: 2x1.750 W
- rapido: 2.700 W
- tripla corona: 3.500 W



Foro incasso stretto

Veronika
standard



Veronika

standard

Codice

Versione

Caratteristiche

Prezzo

7067 062



incasso: 560x480



- AISI 304 satinato
- Dimensioni: **760x500**
- Griglie in ghisa e coprispartifiamma smaltati
- Accensione elettrica
- Valvolatura di sicurezza con termocoppia ad intervento rapido

- Potenza tot. 10.700 W
- ausiliario: 1.000 W
- semirapido: 2x1.750 W
- rapido: 2.700 W
- tripla corona: 3.500 W



Foro incasso stretto

Modello non integrabile in top inox

Accessori: **2** (vedi pag. 401)

7066 052



incasso: 560x480



- AISI 304 satinato
- Dimensioni: **590x500**
- Griglie in ghisa e coprispartifiamma smaltati
- Accensione elettrica
- Valvolatura di sicurezza con termocoppia ad intervento rapido

- Potenza tot. 7.200 W
- ausiliario: 1.000 W
- semirapido: 2x1.750 W
- rapido: 2.700 W

Modello non integrabile in top inox

7063 052



incasso: 420x480



- AISI 304 satinato
- Dimensioni: **440x500**
- Griglie in ghisa e coprispartifiamma smaltati
- Accensione elettrica
- Valvolatura di sicurezza con termocoppia ad intervento rapido

- Potenza tot. 5.850 W
- ausiliario: 1.100 W
- semirapido: 1.750 W
- rapido: 3.000 W

Abbinamento perfetto con lavello Fourtyfour **4151 050** (vedi pag. 147)



Angolare standard



Accessori: **2** (vedi pag. 401)

Codice

7038 052

Versione

 **STD**

Caratteristiche

incasso: vedi sito web

Prezzo

- AISI 304 satinato
- Dimensioni: **830x830**
- Griglie in ghisa e coprispartifiamma smaltati
- Accensione elettrica
- Valvolatura di sicurezza con termocoppia ad intervento rapido

- Potenza tot. 9.750 W
ausiliario: 1.000 W
semirapido: 3x1.750 W
tripla corona: 3.500 W



L'angolo cottura perfetto

Il piano Angolare Foster ottimizza lo spazio dell'angolo grazie alle zone "poggiapentola" in ghisa che danno continuità alle griglie di cottura.

Power
standard

NEW



Codice

7016 032

Versione

STD

Caratteristiche

incasso: 840x480

Prezzo



Modello non integrabile in top inox

- AISI 304 satinato
- Dimensioni: **860x500**
- Griglie in ghisa e coprispartifiamma smaltati
- Accensione elettrica
- Valvolatura di sicurezza con termocoppia ad intervento rapido

- Potenza tot. 11.700 W
semirap. ridotto: 1.400 W
semirapido: 2x1.750 W
rapido: 2.800 W
doppia corona: 4.000 W

NEW

7017 032

STD

incasso: 840x480



Modello non integrabile in top inox

- AISI 304 satinato
- Dimensioni: **860x500**
- Griglie in ghisa e coprispartifiamma smaltati
- Accensione elettrica
- Valvolatura di sicurezza con termocoppia ad intervento rapido

- Potenza tot. 11.300 W
ausiliario: 1.000 W
semirapido: x2 1.750 W
rapido: 2.800 W
doppia corona: 4.000 W

7015 032



incasso: 560x480



- AISI 304 satinato
- Dimensioni: **750x500**
- Griglie in ghisa e coprispartifiamma smaltati
- Accensione elettrica
- Valvolatura di sicurezza con termocoppia ad intervento rapido

- Potenza tot. 10.900 W
ausiliario: 1.000 W
semirapido: 1.750 W
rapido: 2.800 W
semirapido rid.: 1.400 W
doppia corona: 4.000 W

Modello non integrabile in top inox



Foro incasso stretto

NEW

7018 032



incasso: 560 x 480



- AISI 304 satinato
- Dimensioni: **750x500**
- Griglie in ghisa e coprispartifiamma smaltati
- Accensione elettrica
- Valvolatura di sicurezza con termocoppia ad intervento rapido

- Potenza tot. 10.950 W
ausiliario: 1.000 W
semirapido: 1.750 W
semirapido ridotto: 1.400 W
rapido: 2.800 W
doppia corona: 4.000 W

Modello non integrabile in top inox



Foro incasso stretto

7014 032



incasso: 560x480



- AISI 304 satinato
- Dimensioni: **580x500**
- Griglie in ghisa e coprispartifiamma smaltati
- Accensione elettrica
- Valvolatura di sicurezza con termocoppia ad intervento rapido

- Potenza tot. 9.550 W
ausiliario: 1.000 W
semirapido: 1.750 W
rapido: 2.800 W
doppia corona: 4.000 W

Modello non integrabile in top inox

Power glass **NEW** standard



Codice

Versione

Caratteristiche

Prezzo

7044 632

 **STD**

incasso: 840x480



- Vetro nero temprato
- Dimensioni: **900x510**
- Griglie in ghisa e coprispartifiamma smaltati
- Accensione elettrica
- Valvolatura di sicurezza con termocoppia ad intervento rapido

- Potenza tot. 10.950 W
- ausiliario: 1.000 W
- semirapido: 1.750 W
- semirapido ridotto: 1.400 W
- rapido: 2.800 W
- doppia corona: 4.000 W

Power glass standard

NEW

Codice

Versione

Caratteristiche

Prezzo

7042 632



incasso: 560x480



- Vetro nero temprato
- Dimensioni: **700x510**
- Griglie in ghisa e coprispartifiamma smaltati
- Accensione elettrica
- Valvolatura di sicurezza con termocoppia ad intervento rapido

- Potenza tot. 10.950 W
ausiliario: 1.000 W
semirapido: 1.750 W
semirapido ridotto: 1.400 W
rapido: 2.800 W
doppia corona: 4.000 W



Foro incasso stretto

7043 632



incasso: 560x480



- Vetro nero temprato
- Dimensioni: **700x510**
- Griglie in ghisa e coprispartifiamma smaltati
- Accensione elettrica
- Valvolatura di sicurezza con termocoppia ad intervento rapido

- Potenza tot. 10.950 W
ausiliario: 1.000 W
semirapido: 1.750 W
semirapido ridotto: 1.400 W
rapido: 2.800 W
doppia corona: 4.000 W



Foro incasso stretto

7041 632



incasso: 560x480



- Vetro nero temprato
- Dimensioni: **600x510**
- Griglie in ghisa e coprispartifiamma smaltati
- Accensione elettrica
- Valvolatura di sicurezza con termocoppia ad intervento rapido

- Potenza tot. 9.500 W
ausiliario: 1.000 W
semirapido: 1.750 W
rapido: 2800 W
doppia corona: 4.000 W

Piani cottura gas | disegni tecnici

Milanello 5 F

7682 000

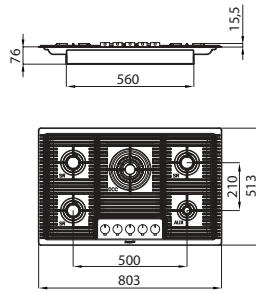

Milanello

7681 000

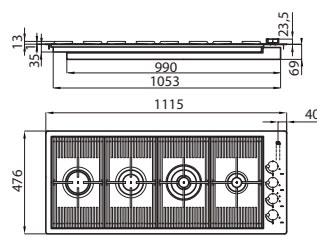

7680 000

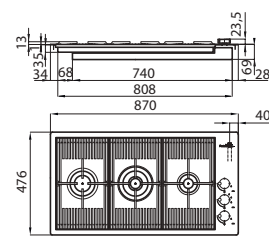

Milano

7639 000

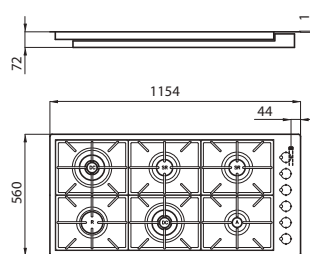

7638 000

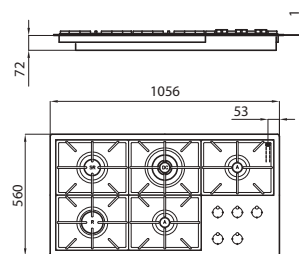

7637 000

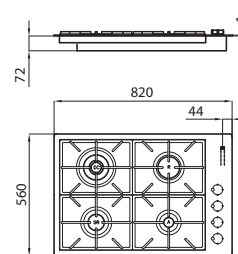

7640 000

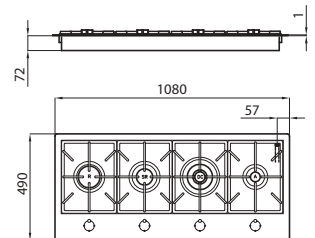

S4000

7257 032

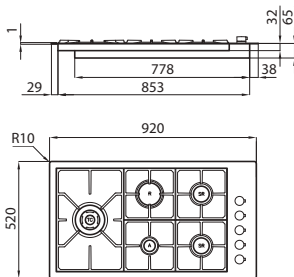

7271 032

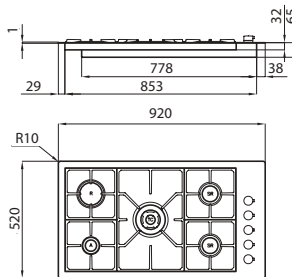

7256 032

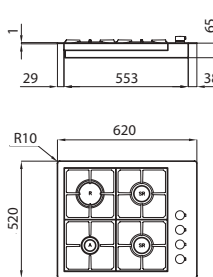

S4000 Domino

7278 032

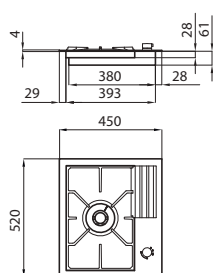

7276 032

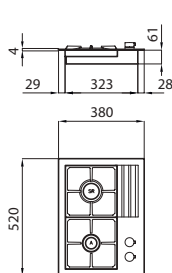

S4000 Line

7284 042

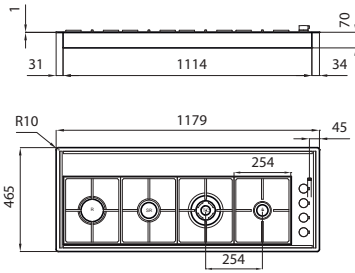

7285 032

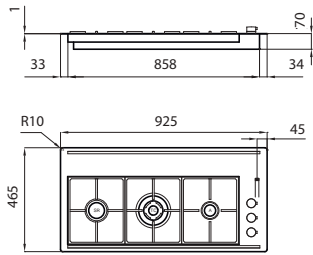

7259 042

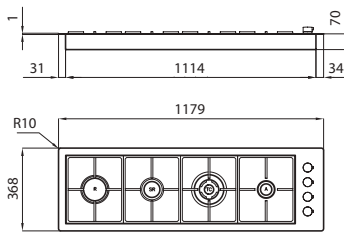

7286 032

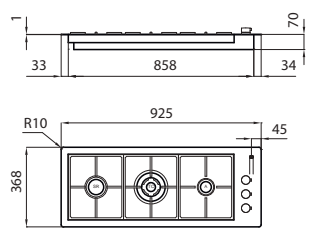

Quadra Angolare | FL

7238 042

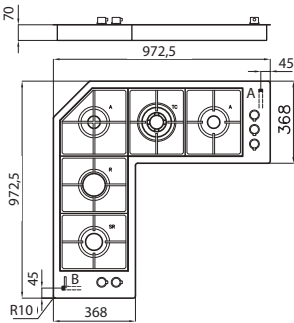

7201 032

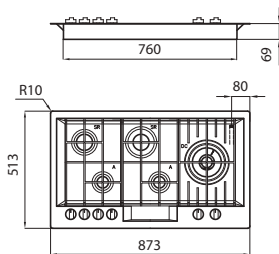

7203 032

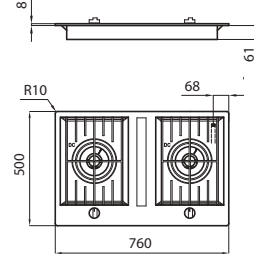

7208 032

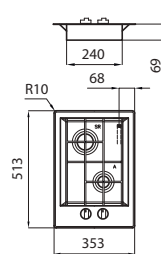

7207 032

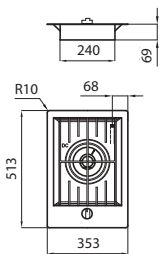

KE

7603 032

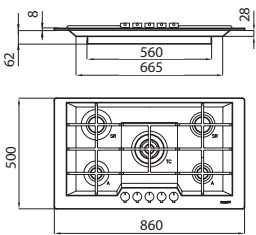

7602 032

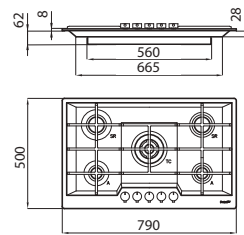

7600 032 - 7601 032

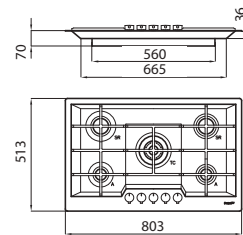

KF NEW

7666 062

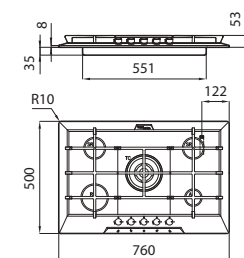

Veronika

7067 062

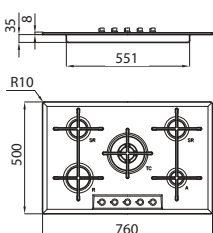

7066 052

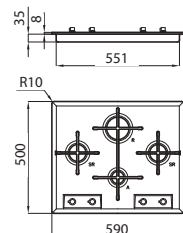

7063 052

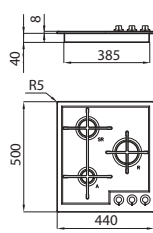

7038 052

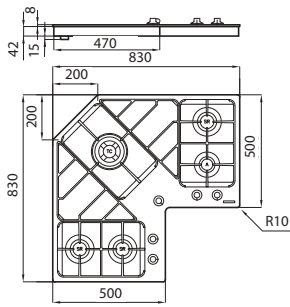

Power

7016 032

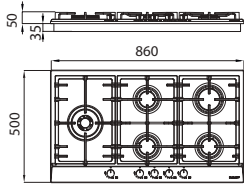

7017 032

NEW

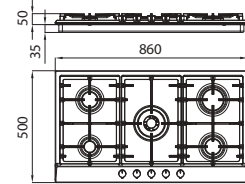

7015 032

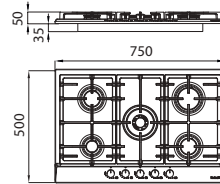

7018 032

NEW

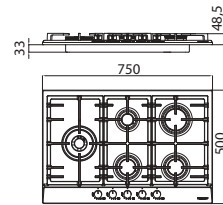

7014 032

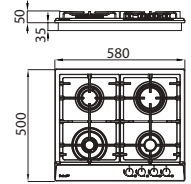

Power Glass

NEW

7044 632

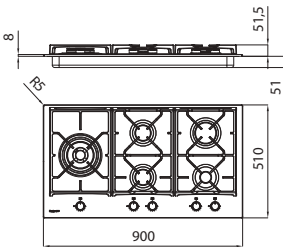

7042 632

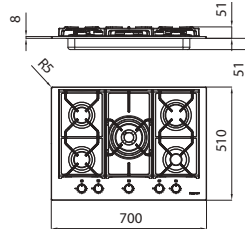

7043 632

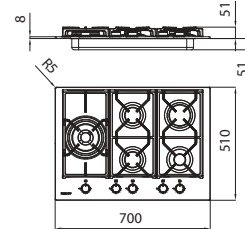

7041 632

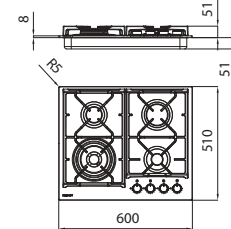

Forni





Forni | caratteristiche



Smaltatura Easy Clean

La speciale smaltatura rende le superfici del forno perfettamente antiaderenti. La minima porosità delle superfici agevola la pulizia.

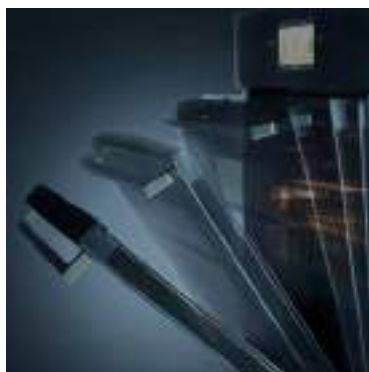

Porta Soft Closing

Le cerniere della porta rallentano automaticamente nella parte finale del movimento per una chiusura sempre delicata e senza rumore.



Guide telescopiche

Favoriscono una migliore distribuzione degli spazi e rendono più agevole l'estrazione delle griglie e delle teglie.



Porta Full Glas

In molti modelli l'interno della porta è un'unica superficie di cristallo liscia, estremamente comoda per le operazioni di pulizia.



Porta con triplo vetro

I forni sono dotati di porta con vetri multipli (fino a 3 vetri). Questo garantisce temperature contenute della porta e minore dispersione termica.



Black Mirror Stop Sol

Il particolare trattamento oscurante e riflettente del cristallo esterno dona al forno un'estetica elegante e moderna.



Finitura anti-touch

Grazie alla speciale protezione, salvaguarda le superfici d'acciaio dalle fastidiose impronte e facilita la pulizia.



Capacità della camera di cottura

Ai vertici della categoria per capacità garantita. XL indica che le versioni hanno capacità maggiore di 60 litri. XXL indica i forni con dimensioni fuori standard, ancora più capienti.



Termosonda

Verifica in ogni istante la temperatura al cuore del prodotto. Una volta impostata la temperatura di cottura il forno avviserà quando è pronto e disattiverà le resistenze.



Self-Cooking

Ampio menù di ricette e grande controllo della temperatura dei cibi. Possibilità di aggiungere ricette personalizzabili.



Tangenziale

La ventilazione tangenziale crea un flusso d'aria tra muffola e telaio riducendo la temperatura delle superfici. Il forno così non sottopone i mobili ad elevati sbalzi termici.

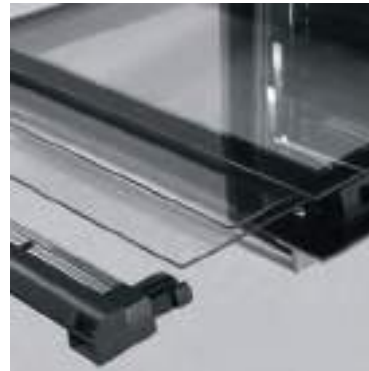

Vetri removibili

I vetri della porta del forno possono essere rimossi per una completa pulizia: i vetri si possono rimuovere con un semplice "click".



Funzioni di cottura forni multifunzione



Cottura sotto

Adatta per riscaldare le vivande.



Cottura superiore

Cottura per cibi particolarmente delicati e per conservare il calore dopo la cottura.



Cottura tradizionale

Funzione ideale per tutte le ricette tradizionali, per pane, torte e arrostiti.



Cottura ventilata

La combinazione tra ventilazione e resistenza circolare permette di cucinare assieme diversi tipi di pietanze senza mescolare odori e sapori.



Cottura intensiva

La resistenza superiore e inferiore insieme alla ventola garantiscono una cottura rapida e uniforme. Ideale per pizza, pane, arrostiti, lasagne e torte salate.



Ventola + cottura sotto

Programma con consumo energetico contenuto, ideale per riscaldare e per alimenti che necessitano di cottura delicata e progressiva.



Preriscaldamento rapido

Questa funzione attiva le resistenze e un flusso d'aria calda consentendo di raggiungere 200°C in tempi rapidi.



Mantenimento calore

Ideale per mantenere alla giusta temperatura di servizio le vostre pietanze.



Cottura sotto + ventilata

L'azione combinata del calore statico da sotto e quello ventilato della resistenza circolare, per cotture profonde per alimenti di elevato spessore.



Grill centrale

Ideale per tostare o gratinare piccole porzioni.



Doppio grill

Il calore viene prodotto solo dal grill superiore: ideale per tostare, gratinare e dorare alimenti, adatto per carne, pesce e pasta.



Cottura sotto + grill

Per portare a termine la cottura statica e contemporaneamente gratinare.



Ventola + grill

Permette una cottura veloce e profonda necessaria per alimenti di grosso volume.



Ventola + doppio grill

Per le fasi finali della cottura di alimenti come arrostiti e pollame, per donare la giusta doratura alle superfici delle pietanze.



Scongelamento

Consente di scongelare in un terzo del tempo i cibi attraverso la distribuzione uniforme dell'aria a temperatura ambiente.



Funzione pizza

La combinazione di cottura inferiore, ventilato e grill consente di ottenere una pizza croccante e cucinata in modo eccellente.



Eco

Consumo energetico minimo. Utilizza il riscaldamento con convezione forzata e interrompe il funzionamento qualche minuto prima del fine cottura sfruttando il calore residuo.



Cottura sotto + grill + ventola

L'uniformità di una cottura ventilata accompagnata dalla croccante gratinatura del grill.

Funzioni di cottura forni a gas



Cottura a gas ventilata e statica

Il calore del bruciatore a gas può essere accompagnato dalla ventilazione in funzione del risultato da ottenere.



Grill + girarrosto

La combinazione di grill e girarrosto permette di ottenere la perfetta doratura delle pietanze.



Grill

Il calore è generato da una resistenza elettrica dall'alto: ideale per tostare, arrostitire, gratinare e rendere croccanti le preparazioni.

Funzioni cottura a vapore

Il **forno combinato a vapore S4001** è un vero e proprio gioiello con prestazioni eccellenti e grande versatilità. Rientra nella classe dei forni **gastronomici**, con una sofisticata tecnologia ereditata dalle soluzioni professionali.

La cottura a vapore si combina con quella a convezione dando vita ad un completo set di programmi, per una cucina da vero gourmet. Qui di seguito le funzioni di cottura specializzate, che si aggiungono ai normali programmi di un forno multifunzione.



Cottura professionale

(combinata a vapore)

Sistema misto che unisce aria calda e vapore per ottenere pietanze gustose e succulenti, di derivazione professionale.



Vapore puro

Le virtù del vapore per una cottura sana e nutriente. Indicato per tutte le pietanze delicate (verdure, pesce,...) e per tutte le cotture a bassa temperatura (sous vide o vasocotture).



Rigenerazione

Un programma apposito per rigenerare le vostre pietanze che utilizza il vapore per restituire la corretta umidità, abbinato ad aria calda tra i 70° e i 130°C.



Funzioni di cottura forno Combi Micro

Il forno **micro+grill S4001** aggiunge alla cottura micro e al grill anche la cottura ventilata, con un incredibile set di programmi cottura. Tanta praticità per il **micro+grill KS**, perfettamente abbinabile ai tanti forni in acciaio.

Qui di seguito le funzioni di cottura specializzate, che si aggiungono ai normali programmi di un forno multifunzione.



Cottura con microonde

Ideale per cuocere o riscaldare verdure, riso, pesce, carne e liquidi in modo rapido. Possono essere impostate differenti potenze di funzionamento.



Microonde ventilato

Il movimento dell'aria generato dalla ventola garantisce una migliore omogeneità delle cotture micro.



Cottura micro + grill

Metodo di cottura combinato perfetto per lasagne, patate, arrostiti e sfornati.



Scongellamento automatico

Permette di scongelare impostando il tipo di alimento e il peso.



Scongellamento a tempo

Permette di scongelare impostando la durata del processo.





442 | **S4001**

446 | **FL 90** 

448 | **KE** 

452 | **KE 90**

453 | **KS**

S4001



S4001

Multifunzione 60 x 60 | 65 litri
Classe A++



Codice	Finitura	Prezzo
--------	----------	--------

7131 057	Satinato anti-touch	
-----------------	------------------------	--

- 15 funzioni di cottura
- Comandi Touch control
- Display con programmazione elettronica intuitiva
- 3 guide telescopiche ad estrazione totale
- Protezione resistenza Grill
- Blocco comandi di sicurezza
- Luce forno indipendente
- Programmazione in 12 lingue
- Modalità Demo
- Alimentazione: 220-240 V 50-60 Hz
- Smaltatura Easyclean
- Tangenziale
- Porta soft closing
- Porta fullglass
- Porta con triplo vetro
- Black mirror stop-sol
- Capacità della camera di cottura XL
- Termosonda
- Self-cooking

Dotazione di serie:

- 2 teglie con smaltatura EasyClean
- 1 griglia in acciaio inox

Funzioni



Disegno tecnico a pag. 454

Combinato a vapore 60 x 46 | 34 litri
Classe A++



Codice	Finitura	Prezzo
--------	----------	--------

7135 087	Satinato anti-touch	
-----------------	------------------------	--

- Immissione controllata del vapore in camera di cottura
- 8 funzioni di cottura
- Comandi Touch control
- Funzione Sbuffo
- Cicli di pulizia assistita forno e circuito vapore
- Camera di cottura in acciaio inox
- Luce forno indipendente
- Programmazione in 12 lingue
- Modalità Demo
- Alimentazione: 220-240 V 50 Hz
- Smaltatura Easyclean
- Porta soft closing
- Porta con triplo vetro
- Black mirror stop-sol
- Termosonda
- Self-cooking
- Tangenziale

Dotazione di serie:

- 1 teglia 2/3 gastronorm H20
- 1 teglia fonda 2/3 gastronorm H40 con coperchio e griglia di supporto inox
- 1 griglia in acciaio inox

Funzioni



Disegno tecnico a pag. 454

S4001

Micro combi 60 x 46 | 34 litri



Codice	Finitura	Prezzo
--------	----------	--------

7136 027	Satinato anti-touch	
-----------------	------------------------	--

- 9 Funzioni di cottura
- Potenza microonde 1000 W
- Comandi Touch control
- Ricettario programmato modificabile
- Funzione scongelamento per tempo e per peso
- Camera di cottura in acciaio inox
- Luce forno indipendente
- Alimentazione: 220-240 V 50 Hz
- Black mirror stop-sol
- Self-cooking
- Tangenziale

Dotazione di serie:

- 1 Piatto girevole integrato Ø 32 cm
- 1 griglia inox circolare
- 1 teglia inox 2/3 gastronorm H20
- 1 griglia inox

Funzioni



Disegno tecnico a pag. 454

Modulo scaldapiatti 60 x 14



Codice	Finitura	Prezzo
--------	----------	--------

7138 001	Satinato anti-touch	
-----------------	------------------------	--

- Modulo 60x14 cm
- Carrello estraibile
- Interno in acciaio inox e base in cristallo
- Temperature: 40 - 70°C
- Adatto a riscaldare e mantenere in temperatura gli alimenti
- Black mirror stop-sol

- Alimentazione: 220-240 V 50 Hz



Disegno tecnico a pag. 454



Allineamento perfetto

Il forno multifunzione alto 60 cm e i forni specializzati alti 46 cm presentano un perfetto allineamento di maniglia e cruscotti prestandosi così ad ogni tipo di abbinamento in verticale ed orizzontale.

FL90



FL90

Multifunzione 90 x 48 | 91 litri
Classe A



7107 640 Inox



NEW

Codice

Finitura

Prezzo

7107 642

Black mirror

- 10 funzioni di cottura
- Display con programmazione elettronica di inizio-fine cottura e comandi push-pull
- Maxi-Grill (abbattibile)
- Protezione resistenza Grill
- Illuminazione alogena su entrambe le pareti, attiva all'apertura della porta
- Interruttore di contatto della porta
- Alimentazione: 220-240V 50-60Hz
- Vetri removibili
- Smaltatura easy clean
- 2 guide telescopiche
- Porta full glass
- Porta con triplo vetro
- Black mirror stop-sol
- Capacità della camera di cottura XXL
- Tangenziale

Dotazione di serie:

- teglia profonda
- griglia inox

Funzioni



7107 646 Gun Metal

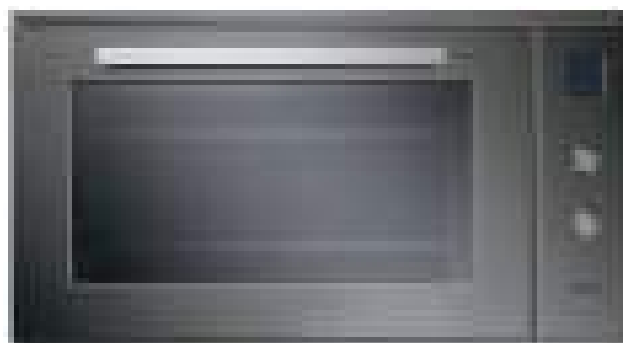

NEW

Disegno tecnico a pag. 454

KE



Multifunzione 75 x 60 | 89 litri
Classe A



Codice

Finitura

Prezzo

7137 000Satinato
anti-touch

- 9 funzioni di cottura
- Programmazione elettronica di inizio-fine cottura
- 1 guida telescopica
- Alimentazione: 220-240 V 50-60 Hz
- Smaltatura easy-clean
- Porta soft closing
- Capacità della camera XL
- Tangenziale
- Vetri removibili
- Porta con triplo vetro
- Porta Full Glass

Dotazione di serie:

- 2 teglie con smaltatura EasyClean
- 1 griglia in acciaio inox

Funzioni



Disegno tecnico a pag. 454

**Abbinamento perfetto con gli altri prodotti
Foster per moduli e basi da 75 cm**



Piano cottura KE
codice 7602 032 (pag. 419)



Cappa New Wing
codice 2512 072 (pag. 475)



Lavello S4001
codice 3138 850 (pag. 257)

KE



Multifunzione 60 x 60 | 70 litri
Classe A



Codice	Finitura	Prezzo
--------	----------	--------

7142 045	Satinato anti-touch	
-----------------	------------------------	--

- 10 funzioni di cottura
- Programmazione elettronica di inizio-fine cottura
- 3 guide telescopiche
- Vetri porta removibili
- Protezione resistenza Grill
- Alimentazione: 220-240 V 50-60 Hz
- Smaltatura easy clean
- Porta soft closing
- Porta full glass
- Porta con triplo vetro
- Capacità della camera di cottura XL
- Tangenziale
- Vetri removibili

Dotazione di serie:

- 1 teglia e 1 leccarda con smaltatura EasyClean XXL
- 1 griglia in acciaio inox

Funzioni



Disegno tecnico a pag. 454

Multifunzione 60 x 60 | 70 litri
Classe A



Codice	Finitura	Prezzo
--------	----------	--------

7141 044	Satinato anti-touch	
-----------------	------------------------	--

- 8 funzioni di cottura
- Programmazione elettronica di inizio-fine cottura
- 1 guida telescopica
- Vetri porta removibili
- Protezione resistenza Grill
- Alimentazione: 220-240 V 50-60 Hz
- Smaltatura easy clean
- Porta soft closing
- Porta full glass
- Porta con triplo vetro
- Capacità della camera di cottura XL
- Tangenziale
- Vetri removibili

Dotazione di serie:

- 1 teglia e 1 leccarda con smaltatura EasyClean XXL
- 1 griglia in acciaio inox

Funzioni



Disegno tecnico a pag. 454

KE90

Multifunzione 90 x 60 | 103 litri
Classe A



Codice

Finitura

Prezzo

7126 047

Satinato
anti-touch

- 9 funzioni di cottura
- Programmazione elettronica di inizio-fine cottura
- Display digitale
- Protezione resistenza grill
- Luce forno indipendente
- Alimentazione: 220-240 V 50-60 Hz
- Smaltatura easy clean
- Porta full glass
- Porta con triplo vetro
- Capacità della camera di cottura XXL
- Tangenziale

Dotazione di serie:

- 2 griglie
- 1 leccarda smaltata

Funzioni



Disegno tecnico a pag. 455

Forno ventilato a gas 90x60 | 91 litri
Classe A



Codice

Finitura

Prezzo

7193 047

Satinato
anti-touch

- 4 funzioni di cottura
- Grill elettrico
- Accensione sottomanopola
- Valvolatura di sicurezza
- Timer di finecottura
- Luce forno indipendente
- Alimentazione: 220-240 V 50-60 Hz
- Smaltatura easy clean
- Porta full glass
- Porta con triplo vetro
- Capacità della camera di cottura XXL
- Tangenziale

Dotazione di serie:

- 1 leccarda
- 1 griglia
- 1 gira arrosto

Note: Il forno viene fornito e collaudato a GPL in dotazione sono presenti gli ugelli per il gas metano.

Funzioni



Disegno tecnico a pag. 455

■ **Multifunzione 60 x 60 | 70 litri**
Classe A



Codice

Finitura

Prezzo

7122 055Satinato
anti-touch

- 8 funzioni di cottura
- Timer di fine cottura
- Porta a 2 vetri
- Vetri porta removibili
- Protezione resistenza Grill
- Alimentazione: 220-240 V 50-60 Hz
- Smaltatura easy clean
- Porta full glass
- Capacità della camera di cottura XL
- Tangenziale

Dotazione di serie:

- 1 teglia e 1 leccarda con smaltatura EasyClean XXL
- 1 griglia in acciaio inox

Funzioni



Disegno tecnico a pag. 455

■ **Micro+grill 60 x 38 | 25 litri**



Codice

Finitura

Prezzo

7151 010Satinato
anti-touch

- 5 funzioni di cottura
- 8 programmi Self Cooking
- 5 livelli potenza fino a 900 W (1000 W Grill)
- Programmazione elettronica
- Scongelamento automatico per tempo e peso
- Camera di cottura in acciaio inox
- Alimentazione: 230 V / 50 Hz

Dotazione di serie:

- 1 griglia
- 1 piatto girevole

Funzioni



Disegno tecnico a pag. 455

S4001

7131 057

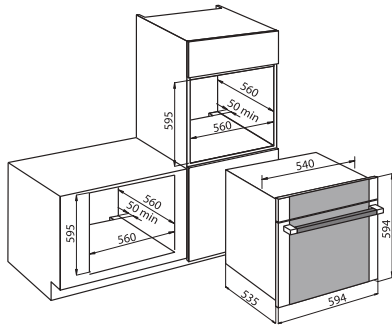

7135 087

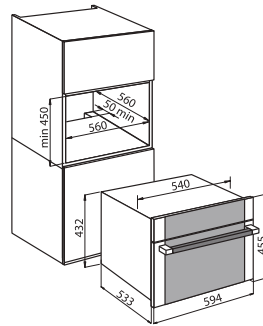

7136 027

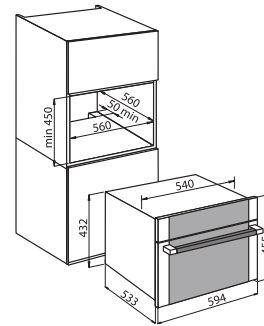

7138 001

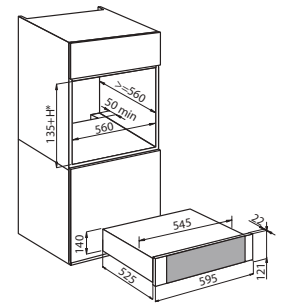

FL90

7107 642

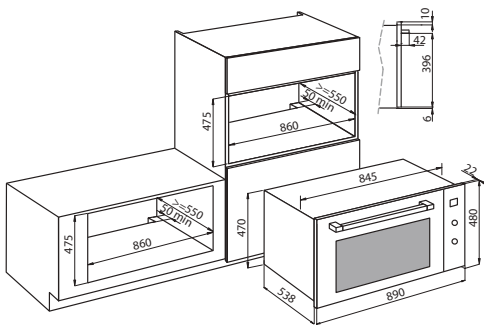

KE

7137 000

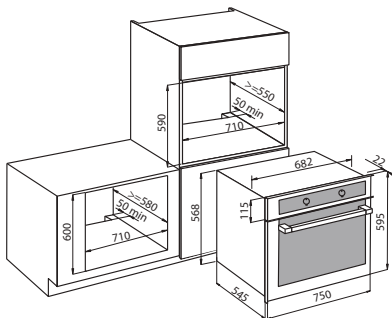

7142 045

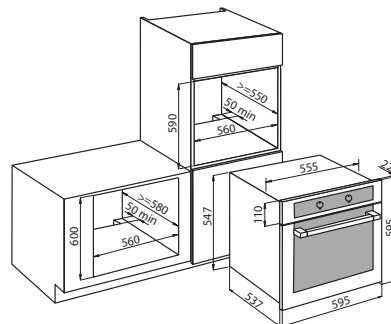

7141 044

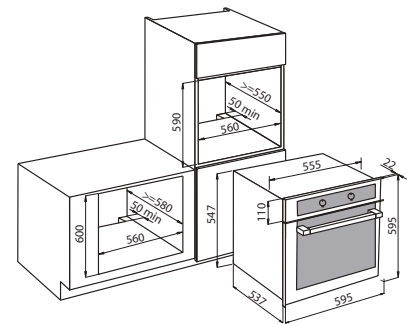

Cappe





Ad ogni cucina la sua **cappa**



Cappe a parete

Una vasta scelta di soluzioni che si differenzia per misure, forme, materiali e funzionalità.



Sistemi di aspirazione a soffitto

Non semplici cappe, ma sistemi di aerazione completi, per migliorare la qualità dell'aria e il comfort.



Cappe da incasso

Spariscono nei pensili della cucina senza perdere la personalità e una grande funzionalità.



Cappe ad isola

Per molti modelli sono disponibili versioni ad isola, installabili in modo versatile grazie ai camini telescopici.



Cappe da tavolo

Eleganti e minimali, si abbinano con i piani in linea e soluzioni domino, sia a gas che a induzione.



Cappe a misura

Progetti su specifica del cliente, sempre con un perfetto abbinamento di design, acciaio e finiture con il top di lavoro.



Caratteristiche



Spegnimento temporizzato

È possibile impostare lo spegnimento ritardato, prolungando l'aerazione dell'ambiente alla fine dell'utilizzo.



Avviso pulizia filtri

Tiene sotto controllo le ore di funzionamento e segnala la necessità del lavaggio filtri, per un'efficienza ottimale.



Motore brushless

Consente portate d'aria importanti con un consumo energetico ridotto. Ha inoltre una durata pressochè infinita.



Ingombro minimo

Sistemi a soffitto che necessitano di poco spazio. È sufficiente un'intercapedine minore di 20 cm tra soffitto e controsoffitto.



Motore remoto

Tramite il Kit Motore Remoto è possibile installare il motore remoto.



Punti luce LED

Illuminazione elegante e di design con punti singoli di luce.



Telecomando

Grazie al controllo remoto è possibile controllare le funzioni della cappa comodamente da qualsiasi punto.



Aspirazione perimetrale

I filtri sono nascosti da inserti e l'aspirazione avviene dalle fessure perimetrali. L'estetica risulta più pulita, la pulizia è semplificata, aspirazione e silenziosità risultano migliorate.



Distanza cappa 50 cm

La cappa può essere inserita a soli 50 cm dal piano, distanza molto inferiore alla norma, con grande efficienza di aspirazione.



Acciaio AISI 304

Pitagora, Cilindro, S4001, Ghost sono realizzate in acciaio inox AISI 304, per un perfetto abbinamento ai piani cottura.



Consigli per la scelta

Dimensionamento e installazione sono importanti per ottimizzare efficienza, prestazioni, consumi e silenziosità. Di seguito alcuni consigli pratici per facilitare la scelta.

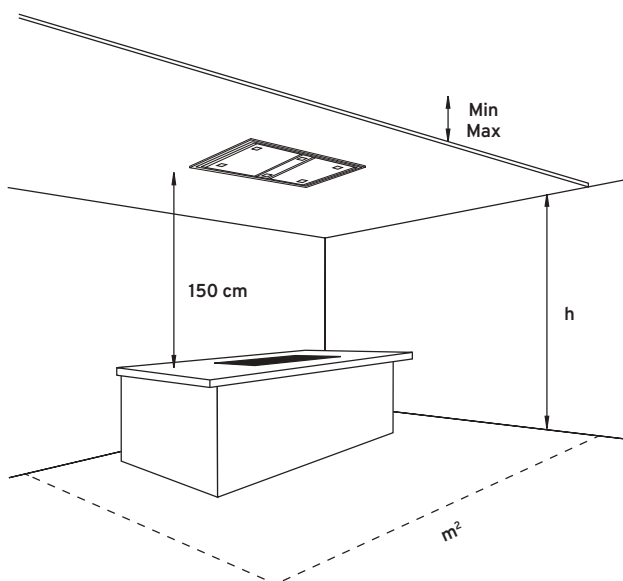

Dimensionamento della portata

La capacità di aspirazione è rapportata al volume dell'ambiente, per garantire un adeguato ricambio d'aria. La portata è calcolata moltiplicando il volume dell'ambiente per 12 (numero di ricambi d'aria in un'ora). Per sistemi a soffitto considerare un ricambio di 15 cicli/ora.

$$\begin{matrix} \text{m}^2 \\ \text{Area cucina} \end{matrix} \times \begin{matrix} h \\ \text{Altezza cucina} \end{matrix} \times \begin{matrix} 12 \\ \text{n. ricambi aria in un'ora} \end{matrix} = \begin{matrix} \text{m}^3/\text{h} \\ \text{Portata (capacità di aspirazione necessaria)} \end{matrix}$$

Posizionamento sul piano di cottura

L'altezza ottimale dal piano cottura è di 65 cm. Nelle cappe a parete con superficie aspirante obliqua si considera l'altezza sulla mediana del filtro di aspirazione.

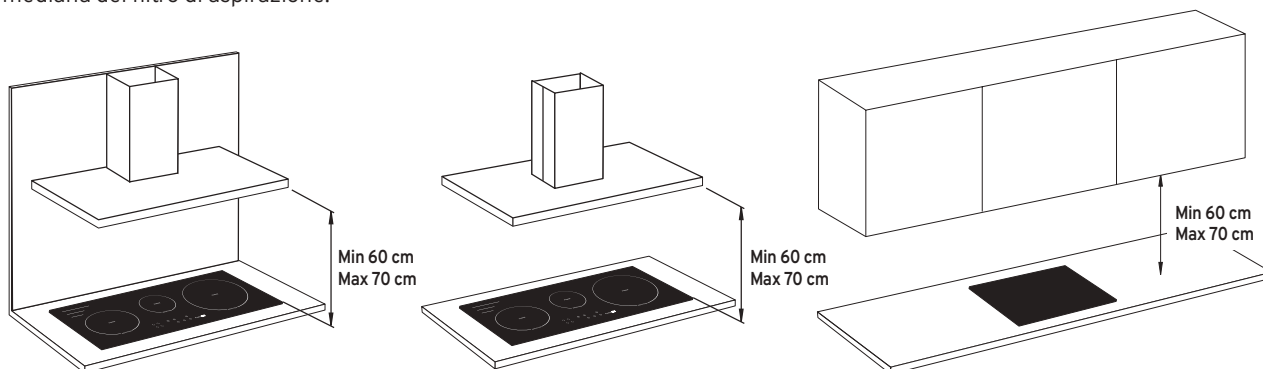

Per i sistemi a soffitto si consiglia di mantenere l'altezza della controsoffittatura ad una altezza non superiore ai 150 cm dal piano di cottura.

Larghezza della cappa

La dimensione deve essere adeguata a quella del piano cottura. Un leggero sovradimensionamento consente un'aspirazione ottimale.

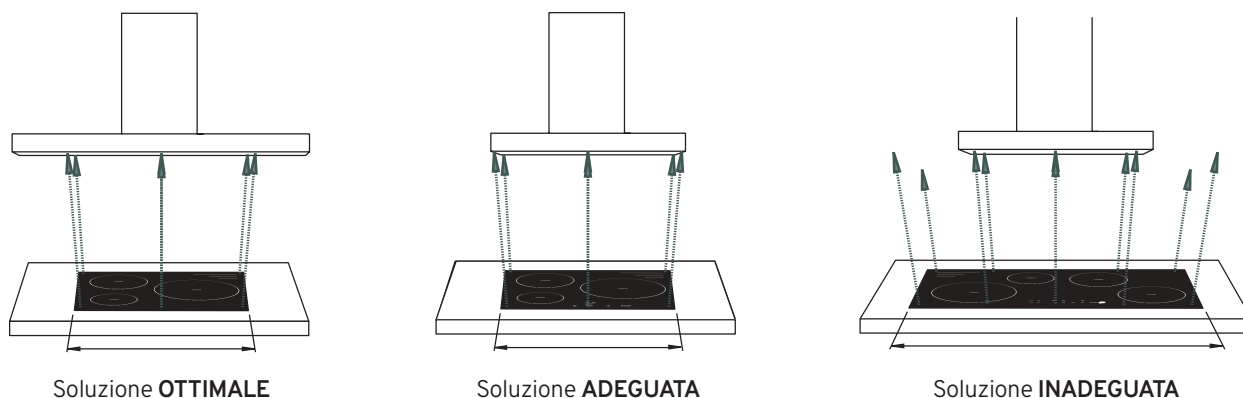

Posizionamento condutture

È bene prevedere condutture dell'aria quanto più possibile dritte. Un percorso tortuoso provocherà una perdita di portata e una conseguente bassa aspirazione. Si raccomanda di non convogliare l'aria in condutture usate per lo scarico fumi.

Correnti d'aria

Per un buon funzionamento è opportuno che la cappa sia posta lontano da correnti d'aria.

Condotti aria

I condotti di scarico dei fumi devono avere un diametro interno non inferiore a 120 mm.

Allacciamento rete elettrica

Tutte le cappe Foster sono predisposte per il collegamento 220-240V 50/60 Hz

Sistemi di canalizzazione per cappe e piani aspiranti

Sistema di canalizzazione Salvaspazio a sezione rettangolare



9700 532

tubo bianco
a sez. rettangolare 222x89 mm
dim: 222x89x1000 mm



9700 533

connettore bianco
a sez. rettangolare 227x94 mm
dim: 227x94x80 mm



9700 534

connettore ad angolo 90° orizz.
sez. rettangolare: 227x94 mm
dim: 288x288x94 mm



9700 535

connettore ad angolo 90° vert.
sez. rettangolare: 227x94 mm
dim: 174x174x227 mm



9700 536

connettore ad angolo 15° orizz.
sez. rettangolare: 227x94 mm
dim: 233x138x94 mm



9700 537

riduzione rett / tondo
sez. 227x94 mm / ø 158 mm
dim: 190x 150x227 mm



9700 538

valvola di non ritorno ø 148 mm



9700 539 *

griglia per zoccolo colore grigio
per zoccoli 100/150 mm
dim: 273x150 mm

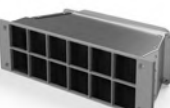

9700 574 *

filtro carbone per zoccolo
100-150 mm



9700 575 *

ricarica carbone attivo per filtro
zoccolo

* solo per piano aspirante e cappe Ghost.



464 **S4001 Special**

466 **S4001**

467 **Cilindro**

468 **Pitagora**

469 **Peraria** **NEW**

471 **Ghost**

473 **Amélie**

474 **KS** **NEW**

475 **New Wing** **NEW**

S4001 Special isola



S4001 Special Isola



Lunghezza	N. punti luce LED	Classe energetica
1201 - 1500	9	A+
1501 - 2100	12	A+
2101 - 3000	15	A

Opzioni, con sovrapprezzo su richiesta:

- Barra portamestoli
- Mensolone inox (H. min 30 mm)
- Tiranti con cavetti in acciaio \varnothing 3 mm*
- Finitura acciaio Vintage
- Camino decentrato
- Camino sagomato per tetto inclinato
- Lato cappa fuori-squadro
- Tiranti tubolari fissi \varnothing 10 mm
- Profondità maggiorata corpo cappa
- Staffe inox a scomparsa per sostegno

Codice	Misura mm	Finitura	Prezzo
2442 150	1201 - 1500	Satinato	
2442 210	1501 - 2100	Satinato	
2442 300	2101 - 3000	Satinato	

- Motore brushless High Performance
- Comandi elettronici Minimal
- 2 filtri antigrasso
- 4 velocità di esercizio
- Illuminazione punti luce LED (1W . 5.600 kelvin)
- Aspirazione perimetrale
- Spegnimento automatico differito
- Funzionamento filtrante opzionale
- Tiranti telescopici in tubolare \varnothing 28 / 25 mm
- 4 sportelli aspiranti (120 cm) in posizione centrale
- Camino in posizione centrale
- Altezza camino: 810 - 1220 mm
- Foro espulsione aria: \varnothing 120/150 mm

M³/h max: 568
M³/h int: 672
Pressione (Pa): 464
Rumorosità max (dbA) : 64
Rumorosità int (dbA) : 68
Potenza (W): 165

Accessori:

Kit filtro carbone Long Life **9700 001**



Disegno tecnico a pag. 476

S4001 Special parete



S4001 Special Parete

Lunghezza	N. punti luce LED	Classe energetica
1201 - 1500	9	A+
1501 - 2100	12	A+
2101 - 3000	15	A

Opzioni su richiesta con sovrapprezzo:

- Barra portamestoli
- Mensolone inox (H. min 30 mm)
- Tiranti con cavetti in acciaio \varnothing 3 mm*
- Finitura acciaio Vintage
- Camino decentrato
- Camino sagomato per tetto inclinato
- Lato cappa fuori-squadro
- Tiranti tubolari fissi \varnothing 10 mm
- Profondità maggiorata corpo cappa
- Staffe inox a scomparsa per sostegno



Disegno tecnico a pag. 476

Codice	Misura mm	Finitura	Prezzo
2440 150	1201 - 1500	Satinato	
2440 210	1501 - 2100	Satinato	
2440 300	2101 - 3000	Satinato	

- Motore brushless High Performance
- Comandi elettronici Minimal
- 2 filtri antigrasso
- 4 velocità di esercizio
- Illuminazione punti luce LED (1W . 5.600 kelvin)
- Aspirazione perimetrale
- Spegnimento automatico differito
- Funzionamento filtrante opzionale
- Tiranti telescopici in tubolare \varnothing 28 / 25 mm

- 4 sportelli aspiranti (120 cm) in posizione centrale
- Camino in posizione centrale
- Altezza camino 630 - 1050 mm
- Foro espulsione aria: \varnothing 120/150 mm

M³/h max: 568
M³/h int: 672
Pressione (Pa): 464
Rumorosità max (dBa) : 64
Rumorosità int (dBa) : 68
Potenza (W): 165

Accessori:

Kit filtro carbone Long Life

9700 001

Tipologie di tiranti



Fissaggio opzionale con cavetti d'acciaio \varnothing 3 mm.



Fissaggio standard con tubolari telescopici \varnothing 28/25 mm



Fissaggio opzionale con tiranti tubolari \varnothing 10 mm



Cappa S4001 a parete con mensolone inox e camino decentrato.

Finiture



Finitura Satinato



Finitura Vintage

S4001



S4001 Isola



Codice	Finitura	Prezzo
--------	----------	--------

2442 091 90 cm	Satinato	
2442 121 120 cm	Satinato	

Cappa aspirante a isola con camino telescopico

- Motore brushless High Performance
- Comandi elettronici Minimal
- 2 filtri antigrasso
- 4 velocità di esercizio
- Illuminazione LED 6 x 1W (5.600 kelvin)
- Aspirazione perimetrale
- Spegnimento automatico differito

- Funzionamento filtrante opzionale

Altezza camino: 630 - 1050 mm
 Foro espulsione aria: Ø 120/150 mm

Classe energetica: A+
 M³/h max: 568
 M³/h int: 672
 Pressione (Pa): 464
 Rumorosità max (dBa) : 64
 Rumorosità int (dBa) : 68
 Potenza (W): 165

Accessori:

Kit filtro carbone Long Life **9700 001**



Disegno tecnico a pag. 476

S4001 Parete



Codice	Finitura	Prezzo
--------	----------	--------

2440 091 90 cm	Satinato	
2440 121 120 cm	Satinato	

Cappa aspirante a parete con camino telescopico

- Motore brushless High Performance
- Comandi elettronici Minimal
- 2 filtri antigrasso
- 4 velocità di esercizio
- Illuminazione LED 6 x 1W (5.600 kelvin)
- Aspirazione perimetrale
- Spegnimento automatico differito

- Funzionamento filtrante opzionale

Altezza camino: 810 - 1220 mm
 Foro espulsione aria: Ø 120/150 mm

Classe energetica: A+
 M³/h max: 568
 M³/h int: 672
 Pressione (Pa): 464
 Rumorosità max (dBa) : 64
 Rumorosità int (dBa) : 68
 Potenza (W): 165

Accessori:

Kit filtro carbone Long Life **9700 001**



Disegno tecnico a pag. 476

Cilindro



Cilindro Wall



Codice

Finitura

Prezzo

2531 001

Satinato

Ø 38 cm

Cappa aspirante a parete

- Comandi elettronici Minimal
- 1 filtro antigrasso in acciaio inox
- 4 velocità di esercizio
- Illuminazione LED 4 x 1,2W (5.500 kelvin)
- Spegnimento automatico differito
- Motore brushless

Altezza: 920 mm

Foro espulsione aria: Ø 120/150 mm

Funzionamento filtrante opzionale

Classe energetica: A+

M³/h max: 550

M³/h int: 652

Pressione (Pa): 462

Rumorosità max (dbA) : 63

Rumorosità int (dbA) : 67

Potenza (W): 165

Accessori:

Filtro carbone

9700 380



Disegno tecnico a pag. 476

Cilindro Isola



Codice

Finitura

Prezzo

2530 001

Satinato

Ø 38 cm

Cappa aspirante telescopica a isola

- Comandi elettronici Minimal
- 1 filtro antigrasso in acciaio inox
- 4 velocità di esercizio
- Illuminazione LED 4 x 1,2W (5.500 kelvin)
- Spegnimento automatico differito
- Motore brushless

Altezza: 920 - 1330 mm

Foro espulsione aria: Ø 120/150 mm

Funzionamento filtrante opzionale

Classe energetica: A+

M³/h max: 550

M³/h int: 652

Pressione (Pa): 462

Rumorosità max (dbA) : 63

Rumorosità int (dbA) : 67

Potenza (W): 165

Accessori:

Filtro carbone

9700 380



Disegno tecnico a pag. 476

Pitagora



■ Pitagora



Codice

Finitura

Prezzo

2439 003

Satinato

90x90 cm

Cappa aspirante angolare
con camino telescopico

- Comandi elettronici Minimal
- 2 filtri antigrasso in alluminio anodizzato
- 4 velocità di esercizio
- Illuminazione LED 2 x 1,2W (4.000 kelvin)
- Spegnimento automatico differito

Accessori:

Filtro carbone **9700 409**

Altezza camino:

450 - 850 mm

Foro espulsione aria:

Ø 150 mm

Funzionamento filtrante
opzionale

Classe energetica: A

M³/h max: 557

M³/h int: 751

Pressione (Pa): 473

Rumorosità max (dbA) : 64

Rumorosità int (dbA) : 70

Potenza (W): 290



**AISI
304**

Disegno tecnico a pag. 476



■ Peraria Inox



Codice	Finitura	Prezzo
--------	----------	--------

2522 101
100 cm

Satinato

Cappa aspirante a soffitto

- Telecomando
- 2 filtri antigrasso
- 4 velocità di esercizio
- Aspirazione perimetrale
- Motore brushless

Foro espulsione aria:

222 x 90 mm

Distanza soffitto-controsoffitto:

min 184 mm / max 250 mm

Foro incasso: 476 x 976

Funzionamento filtrante
opzionale

Accessori:

Filtro carbone **9700 592**

Classe energetica: A++

M³/h max: 584

M³/h int: 725

Pressione (Pa): 477

Rumorosità max (dBa) : 65

Rumorosità int (dBa) : 70

Potenza (W): 165



Disegno tecnico a pag. 476

■ Peraria White



Codice	Finitura	Prezzo
--------	----------	--------

2522 111
100 cm

Bianca

Cappa aspirante a soffitto

- Telecomando
- 2 filtri antigrasso
- 4 velocità di esercizio
- Aspirazione perimetrale
- Motore brushless

Foro espulsione aria:

222 x 90 mm

Distanza soffitto-controsoffitto:

min 184 mm / max 250 mm

Foro incasso: 476 x 976

Funzionamento filtrante
opzionale

Accessori:

Filtro carbone **9700 592**

Classe energetica: A++

M³/h max: 584

M³/h int: 725

Pressione (Pa): 477

Rumorosità max (dBa) : 65

Rumorosità int (dBa) : 70

Potenza (W): 165



Disegno tecnico a pag. 476



Ghost



Ghost 90 Filotop



FT SPT

Codice | Finitura | Prezzo

2451 090
90 cm | Satinato
Vetro nero

Cappa aspirante da tavolo

- Telecomando
- 2 filtri antigrasso in alluminio anodizzato
- 4 velocità di esercizio
- Illuminazione LED Strip (5W . 4.200 kelvin)
- Avviso pulizia filtri
- Spegnimento automatico differito

Altezza dal piano: 300 mm
Dimensioni sul piano: 875 x 120 mm
Foro incasso:

- installazione sopratop:
842 x 100 mm

- installazione filotop:
vedi disegno tecnico

Foro espulsione aria: Ø 120/150 mm

Classe energetica: A

M³/h max: 503

M³/h int: 757

Pressione (Pa): 477

Rumorosità max (dba) : 61

Rumorosità int (dba) : 68

Potenza (W): 280

Accessori:

Filtro carbone **9700 497**

Kit motore remoto **9700 459**

Nota: Il motore può essere posizionato frontalmente, sul retro della cappa e in modalità remota con l'apposito kit opzionale.

Ghost 120 Filotop



FT SPT

Codice | Finitura | Prezzo

2451 120
120 cm | Satinato
Vetro nero

Cappa aspirante da tavolo

- Telecomando
- 2 filtri antigrasso in alluminio anodizzato
- 4 velocità di esercizio
- Illuminazione LED Strip (5W . 4.200 kelvin)
- Avviso pulizia filtri
- Spegnimento automatico differito

Altezza dal piano: 300 mm
Dimensioni sul piano: 1175 x 120 mm
Foro incasso:

- installazione sopratop:
1142 x 100 mm

- installazione filotop:
vedi disegno tecnico

Foro espulsione aria: Ø 120/150 mm

Classe energetica: A

M³/h max: 500

M³/h int: 791

Pressione (Pa): 480

Rumorosità max (dba) : 58

Rumorosità int (dba) : 65

Potenza (W): 284

Accessori:

Filtro carbone **9700 460**

Kit motore remoto **9700 459**

Nota: Il motore può essere posizionato frontalmente, sul retro della cappa e in modalità remota con l'apposito kit opzionale.



Schemi di installazione con kit motore remoto

Le parti in rosso nel disegno costituiscono un kit per l'installazione del motore in modalità remota, fino ad una distanza di 5 metri.

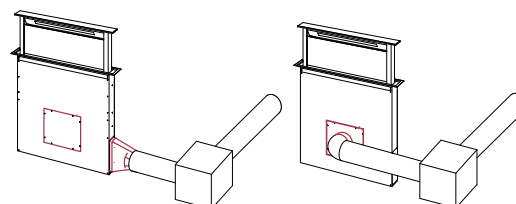

Disegno tecnico a pag. 477

S4000 Domino Ghost



Domino Ghost



Le cappe Ghost offrono una grande versatilità di installazione. Il motore può essere posizionato frontalmente, sul retro della cappa e in modalità remota con l'apposito kit opzionale (vedi disegno tecnico).

Schemi di installazione con kit motore remoto

Le parti in rosso nel disegno costituiscono un kit per l'installazione del motore in modalità remota, fino ad una distanza di 5 metri.

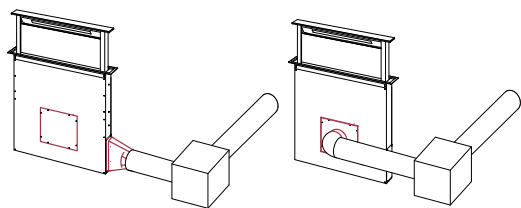

Codice

2451 000
52 cm

Finitura

Satinato
Vetro nero

Prezzo

Cappa aspirante da tavolo
• Comandi elettronici Touch
• 1 filtro antigrasso
• 4 velocità di esercizio
• Aspirazione su due lati
• Avviso pulizia filtri
• Spegnimento automatico differito

Altezza dal piano:
regolabile 180 - 300 mm
Dimensioni sul piano: 520 x 120 mm
Foro incasso: 490 x 104 mm
Foro espulsione aria: Ø 120/150 mm

Classe energetica: B
M³/h max: 636
M³/h int: 636
Pressione (Pa): 446
Rumorosità max (dBa) : 69
Rumorosità int (dBa) : 69
Potenza (W): 275

Accessori:

Kit 2 filtri carbone

9700 450

Kit installazione motore remoto

9700 459



Disegno tecnico a pag. 477

Amélie



Amélie



Codice

Finitura

Prezzo

2447 090

Satinato

90 cm

Cappa aspirante a parete
con camino telescopico

- Comandi elettronici soft touch
- 3 filtri antigrasso
- 3 velocità di esercizio
- Illuminazione LED 2 x 1,2W
(4.000 kelvin)

Altezza camino:

- in modalità aspirante:

580 - 1000 mm

- in modalità filtrante:

50 - 1070 mm

Foro espulsione aria: Ø 120/150 mm

Funzionamento filtrante opzionale

Classe energetica: A

M³/h max: 480

M³/h int: 618

Pressione (Pa): 402

Rumorosità max (dbA) : 64

Rumorosità int (dbA) : 67

Potenza (W): 224

Accessori:

Kit filtri carbone **9700 517**

Disegno tecnico a pag. 477

KS

NEW



KS inox



Codice

Finitura

Prezzo

2504 194 90 cm Satinato

Cappa aspirante a parete con camino telescopico

- Comandi elettronici
- 3 filtri antigrasso
- 4 velocità di esercizio
- Illuminazione LED 2 x 1,2W (4.000 kelvin)

Accessori:

Filtro carbone **9700 517**

Altezza camino:

- in modalità aspirante: 580 - 1000 mm
- in modalità filtrante: 650 - 1070 mm
- Foro espulsione aria: Ø 120/150 mm

Classe energetica: A

- M³/h max: 632
- Pressione (Pa): 384
- Rumorosità max (dbA) : 66
- Potenza (W): 224

KS black



Codice

Finitura

Prezzo

2504 394 90 cm Nero

Cappa aspirante a parete con camino telescopico

- Comandi elettronici
- 3 filtri antigrasso
- 4 velocità di esercizio
- Illuminazione LED 2 x 1,2W (4.000 kelvin)

Accessori:

Filtro carbone **9700 517**

Altezza camino:

- in modalità aspirante: 580 - 1000 mm
- in modalità filtrante: 650 - 1070 mm
- Foro espulsione aria: Ø 120/150 mm

Classe energetica: A

- M³/h max: 632
- Pressione (Pa): 384
- Rumorosità max (dbA) : 66
- Potenza (W): 224

Disegno tecnico a pag. 477

New Wing NEW



L'unica cappa che può stare a soli 50 cm dal piano cottura

New Wing



Codice

Finitura

Prezzo

2512 062 60 cm

Satinato/vetro

NEW **2512 072** 75 cm*

Satinato/vetro

2512 092 90 cm

Satinato/vetro

NEW **2512 122** 120 cm

Satinato/vetro

Cappa aspirante da incasso sottopensile

- Comando rotativo Smart
- Filtri antigrasso in alluminio
- 4 velocità di esercizio
- Illuminazione LED 2 x 1,2W (4.000 kelvin)
- Profili di protezione pensili in acciaio inox
- Regolatore di profondità telescopico
- Profilo ferma-schienale pensile

Altezza minima dal piano:

soli 50 cm

Foro espulsione aria:

Ø 150 mm

Funzionamento filtrante opzionale

Accessori:

Kit filtri carbone **9700 221**



Disegno tecnico a pag. 477

* Per un perfetto abbinamento vedi gli altri prodotti per basi e moduli da 75 a pagina 449

S4001 Special isola

2442 150
2442 210
2442 300

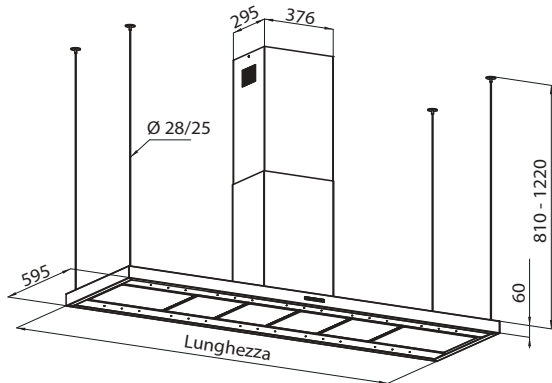

S4001 Special parete

2440 150
2440 210
2440 300

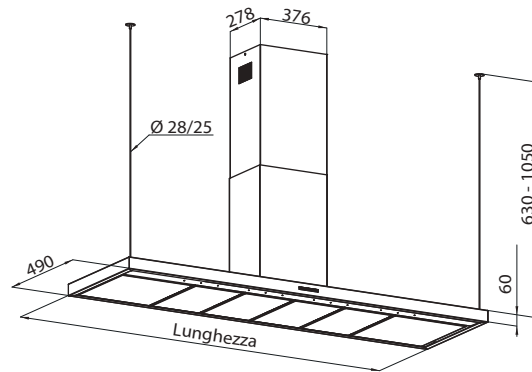

S4001 isola

2442 091 90 cm
2442 121 120 cm

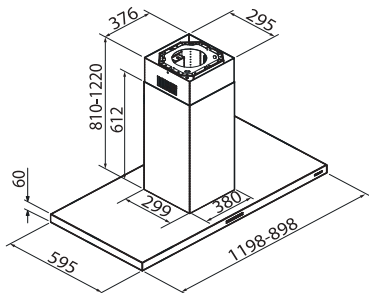

S4001 parete

2440 091 90 cm
2440 121 120 cm

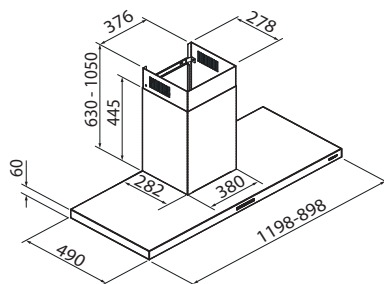

Cilindro Wall

2531 001

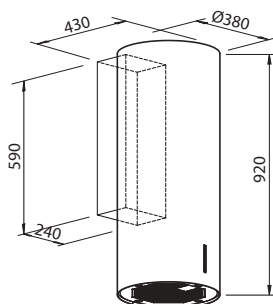

Cilindro Isola

2530 001

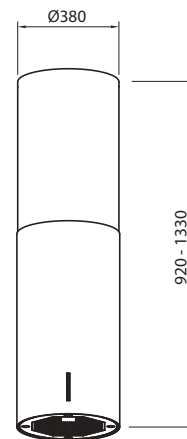

Pitagora

2439 003

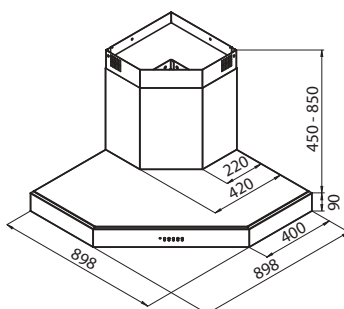

Peraria **NEW**

2522 101
2522 111

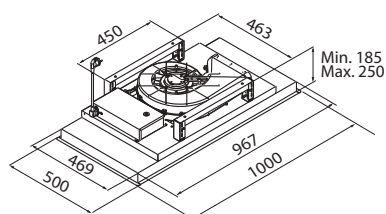

Ghost

2451 090 90 cm

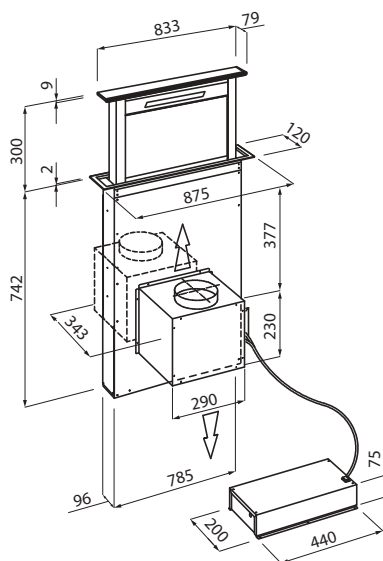

Foro per installazione filotop

2451 120 120 cm

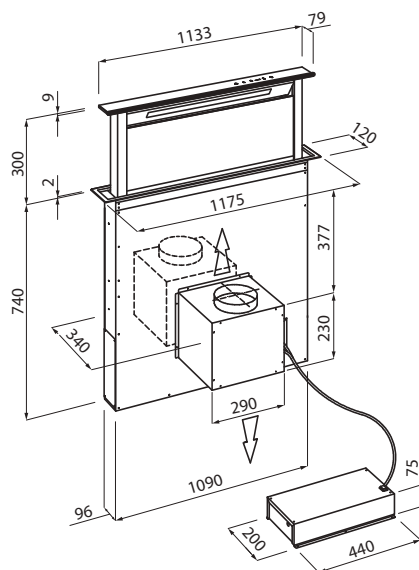

Foro per installazione filotop

Domino Ghost

2451 000

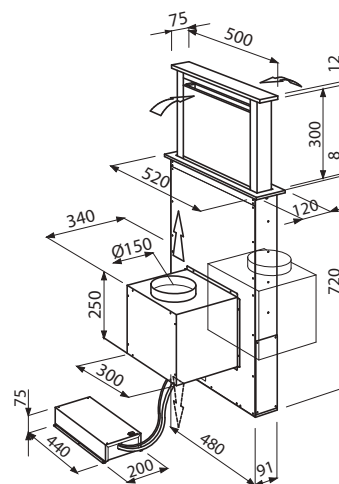

Amélie

2447 090

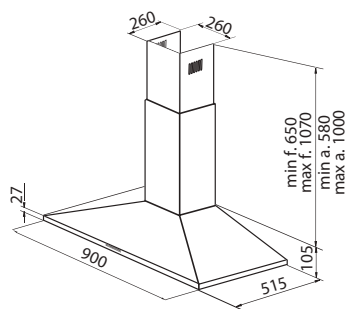

KS NEW

2504 194
2504 394

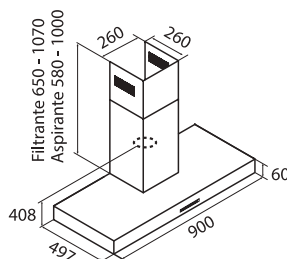

New Wing NEW



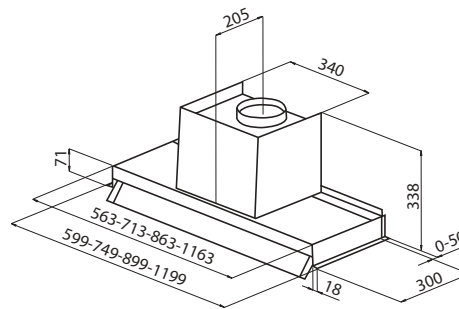





2512 062 60 cm 2512 092 90 cm
2512 072 75 cm 2512 122 120 cm



Lavastoviglie



Funzioni di lavaggio

-  **Programmi**
Set di programmi pratici e essenziali e una programmazione completa e sofisticata adatta ad ogni singola esigenza.
-  **Acquastop**
Blocca l'alimentazione dell'acqua e impedisce alla fonte perdite e trabocchi. È in dotazione su tutti i modelli.
-  **Cestello regolabile**
Il cestello superiore è regolabile in altezza con un semplice gesto, anche a pieno carico.
-  **Extra rapid**
Un ciclo più rapido degli altri che permette di lavare le stoviglie in poco tempo
-  **Mezzo carico**
Risparmio di tempo e di consumi con la impostazione mezzo carico, disponibile su tutti i programmi.
-  **Programmazione differita**
Per impostare il funzionamento in modo da ottimizzare il consumo di energia nel corso della giornata.
-  **Tabs "All in 1"**
Risultati ottimizzati con tutti i tipi di detersivo, dalle pratiche tabs "all in one" al detersivo classico.
-  **Coperti**
Grazie ad un arredo attentamente progettato le lavastoviglie Foster sono molto capienti, fino ai 12 coperti.
-  **Efficienza**
Una gamma che raggiunge la classe di merito delle nuove normative europee.



Caratteristiche

- Lavastoviglie a scomparsa totale
- Classe energetica E
- Numero coperti 12
- Consumo energia: 92 kWh/ 100 cicli Eco
- Consumo acqua per ciclo: 12 litri
- Emissione rumore: 47 dB(A) classe C
- Spie mancanza sale-brillantante
- Regolazione frontale dei piedini posteriori
- Altezza piedini 0-50 mm
- Cestello portaposate

Programmi di lavaggio

intensivo, prelavaggio, quick 30', eco, daily clean.

Dati tecnici

tensione di alimentazione: 220-240 V - 50Hz

Limiti dimensionali pannello porta:

Altezza 647-717 mm

Peso pannello: 3 - 8 Kg

Codice

Prezzo

2950 002

Accessori optional:

2910 018 Pannello porta in acciaio inox (Vedi pag. 481)

Funzioni



Disegno tecnico a pag. 481

Elettra

2950 002

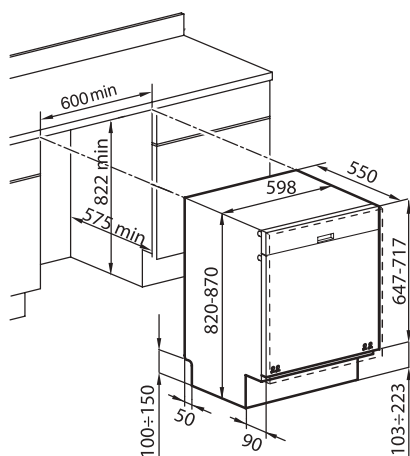

Pannello porta acciaio inox

2910 018



Finitura: AISI 304 satinato
Misure: 595 x 716 x 20 mm

La maniglia integrata si abbina facilmente a qualsiasi anta cucina.
Compatibile con lavastoviglie Elettra.

Le realizzazioni su misura

sono tra gli elementi più distintivi delle produzioni Foster.

Per conoscere tutte le possibilità di realizzazioni di piani di lavoro su misura, in acciaio e in materiali compositi, si rimanda alla documentazione tecnica dell'azienda del **Gruppo Foster** specializzate nelle realizzazioni on demand.

www.bautek.it e www.fostersurfaces.it



Un unico materiale, tanti diversi look grazie ad una gamma di proposte che spazia tra i **classici satinati**, i nuovi trattamenti **ruvidi** e **opachi** e il tocco retrò della **finitura Vintage**.



Diverse finiture.

Differenti profili e spessori.

Supporti autoportanti.

Infinite soluzioni per ogni esigenza di progetto.

Un piano speciale di Foster vuole dire anche la sicurezza di una **qualità artigianale di altissimo livello** e la **garanzia di un unico produttore** sull'intero manufatto.



Anche quello che non si vede è importante. Tutti i nostri top sono realizzati con materiali di primissima scelta e hanno una struttura interna che li rende autoportanti.











Ricerca prodotti per codice

1011 050	111	1130 069	70	1236 050	127	1561 201	185
1012 050	111	1130 860	252	1237 050	127	1561 202	185
1013 850	231	1130 866	29	1250 051	149	1562 001	184
1014 850	230	1130 868	52	1250 052	149	1562 002	184
1015 850	230	1130 869	70	1251 051	149	1579 660	189
1016 850	230	1144 001	199	1251 052	149	1611 060	185
1017 050	110	1144 002	199	1252 051	149	1679 660	189
1017 055	110	1144 061	199	1252 052	149	1679 860	280
1018 050	110	1144 062	199	1254 050	116	1715 015	83
1018 055	110	1179 061	198	1254 056	27	1715 016	28
1024 050	110	1179 062	198	1254 850	236	1715 050	123
1025 050	110	1180 150	202	1254 856	27	1715 055	83
1031 050	105	1180 156	33	1255 050	116	1715 056	28
1031 850	224	1186 161	197	1255 056	26	1715 815	83
1034 050	104	1186 162	197	1255 850	236	1715 816	29
1034 056	25	1197 161	197	1255 856	27	1715 850	242
1034 058	49	1197 162	197	1257 050	116	1715 855	83
1034 059	67	1197 461	197	1257 056	26	1715 856	29
1034 850	224	1197 462	197	1257 850	236	1717 015	82
1034 856	25	1205 050	129	1257 856	26	1717 016	28
1034 858	49	1214 850	249	1279 060	198	1717 050	123
1034 859	67	1215 050	129	1300 068	278	1717 055	82
1040 051	104	1215 850	248	1303 860	282	1717 056	28
1040 052	104	1217 850	248	1410 000	143	1717 815	83
1040 851	224	1218 050	128	1412 000	143	1717 816	28
1040 852	224	1218 850	248	1416 001	143	1717 850	242
1043 051	104	1219 050	128	1416 002	143	1717 855	83
1043 052	104	1220 050	128	1511 001	185	1717 856	28
1129 000	199	1221 050	129	1511 002	185	1718 050	123
1130 060	132	1221 850	249	1513 201	184	1718 850	242
1130 066	29	1229 050	128	1513 202	184	1735 050	122
1130 068	52	1235 050	127	1555 600	188	1737 050	122

1773 100	351	2155 058	50	2157 086	30	2269 080	159
1811 050	278	2155 059	68	2157 840	273	2272 050	159
1812 161	197	2155 080	161	2157 850	267	2274 050	159
1812 162	197	2155 086	30	2157 855	85	2278 050	158
1840 850	283	2155 840	273	2157 856	30	2279 050	159
1845 850	283	2155 850	267	2157 858	50	2280 051	156
1850 850	282	2155 855	85	2157 859	68	2280 052	156
1865 850	276	2155 856	31	2157 880	267	2283 050	156
1870 850	276	2155 858	51	2157 886	30	2287 050	156
1886 160	198	2155 859	69	2157 888	50	2297 051	155
1971 061	179	2155 880	267	2157 889	68	2297 052	155
1971 062	179	2155 886	31	2201 851	267	2439 003	468
1971 961	181	2155 888	51	2201 852	267	2440 091	466
1971 962	181	2155 889	69	2202 851	266	2440 121	466
1972 061	179	2156 050	161	2202 852	266	2440 150	465
1972 062	179	2156 056	32	2203 850	266	2440 210	465
1972 961	181	2156 080	161	2204 851	266	2440 300	465
1972 962	181	2156 086	32	2204 852	266	2442 091	466
1974 060	179	2156 850	268	2205 850	265	2442 121	466
1974 960	181	2156 856	32	2206 850	265	2442 150	464
2151 850	269	2156 858	51	2207 850	265	2442 210	464
2151 856	33	2156 859	69	2211 051	155	2442 300	464
2152 850	269	2156 880	268	2211 052	155	2447 090	473
2153 850	268	2156 886	32	2263 051	155	2451 000	472
2153 856	32	2156 888	51	2263 052	155	2451 090	471
2154 050	161	2156 889	69	2264 050	159	2451 120	471
2154 056	31	2157 050	160	2264 080	159	2504 194	474
2154 850	268	2157 055	84	2265 050	159	2504 394	474
2154 856	31	2157 056	30	2265 080	159	2512 062	475
2155 050	161	2157 058	50	2266 050	158	2512 072	475
2155 055	85	2157 059	68	2266 080	158	2512 092	475
2155 056	30	2157 080	160	2269 050	159	2512 122	475

2522 101	469	3219 051	169	4350 006	23	5554 346	22
2522 111	469	3219 052	169	4350 008	47	5554 348	46
2530 001	467	3274 050	171	4350 009	65	5554 349	64
2531 001	467	3303 060	192	4350 051	218	5555 240	212
2910 018	481	3308 050	192	4350 056	24	5555 246	22
2950 002	480	3352 050	138	4350 058	48	5555 248	46
2975 060	153	3352 850	255	4350 059	66	5555 249	64
2977 060	153	3353 050	139	4371 001	98	5555 340	213
3024 800	347	3353 850	256	4371 006	23	5555 346	22
3024 801	353	3355 050	139	4371 008	47	5555 348	46
3024 880	348	3355 850	256	4371 009	65	5555 349	64
3024 881	354	3356 050	139	4371 051	218	5557 240	212
3025 800	347	3356 850	256	4371 056	23	5557 246	22
3025 801	353	3357 050	138	4371 058	47	5557 248	46
3025 880	348	3357 850	255	4371 059	65	5557 249	64
3025 881	354	3358 050	138	4500 051	165	5557 340	213
3026 800	347	3358 850	255	4500 052	165	5557 346	22
3026 880	348	3363 050	135	4502 050	166	5557 348	46
3135 850	262	3365 050	135	4503 051	165	5557 349	64
3136 850	262	3366 050	135	4503 052	165	5812 061	174
3137 850	262	3367 050	134	4504 051	165	5812 062	174
3138 850	257	3780 000	360	4504 052	165	5886 060	175
3139 850	260	4151 050	147	4505 050	166	7014 032	427
3141 850	260	4340 001	98	5186 061	175	7015 032	427
3143 850	260	4340 006	24	5186 062	175	7016 032	426
3212 051	169	4340 008	48	5197 061	175	7017 032	426
3212 052	169	4340 009	66	5197 062	175	7018 032	427
3216 051	169	4340 051	218	5554 240	212	7038 052	424
3216 052	169	4340 056	24	5554 246	22	7041 632	429
3217 000	171	4340 058	48	5554 248	46	7042 632	429
3218 001	171	4340 059	66	5554 249	64	7043 632	429
3218 002	171	4350 001	98	5554 340	213	7044 632	428

7063 052	423	7286 032	413	7374 300	382	7680 009	76
7066 052	423	7321 240	380	7381 646	375	7682 000	402
7067 062	423	7322 240	380	7382 646	375	7681 000	405
7107 640	447	7322 300	383	7384 646	375	7681 006	40
7107 642	447	7325 455	379	7385 646	376	7681 008	58
7107 646	43	7330 255	378	7386 646	376	7681 009	76
7122 055	453	7341 255	379	7391 245	371	7682 000	402
7126 047	452	7341 655	379	7392 246	369	7682 006	40
7131 057	443	7361 270	387	7600 032	419	7682 008	58
7135 087	443	7362 300	387	7601 032	420	7682 009	76
7136 027	444	7363 350	387	7601 632	42	8000 010	304
7137 000	449	7364 270	389	7601 866	60	8000 011	303
7138 001	444	7365 020	391	7601 932	78	8000 012	303
7141 044	451	7365 030	391	7602 032	419	8000 014	303
7142 045	451	7365 040	391	7603 032	419	8000 015	304
7151 010	453	7365 300	389	7637 000	407	8000 017	304
7193 047	452	7366 020	390	7638 000	407	8000 018	303
7201 032	416	7366 030	390	7638 006	41	8000 020	350
7203 032	417	7366 040	390	7638 008	59	8000 028	305
7206 032	416	7366 350	389	7638 009	77	8000 113	304
7206 082	416	7367 020	389	7639 000	406	8000 115	304
7207 032	417	7367 030	389	7639 006	41	8000 116	42
7208 032	417	7367 040	389	7639 008	59	8000 116	304
7238 042	414	7368 020	387	7639 009	77	8000 117	304
7256 032	409	7368 030	387	7640 000	407	8000 118	304 / 61
7257 032	409	7368 040	387	7640 006	41	8000 119	304 / 79
7259 042	413	7369 020	387 / 389	7640 008	59	8000 214	303
7271 032	409	7369 030	387 / 389	7640 009	77	8000 215	304
7276 032	410	7369 040	387 / 389	7666 062	421	8000 217	304
7278 032	410	7370 300	383	7680 000	405	8000 315	304
7284 042	412	7371 300	382	7680 006	40	8000 317	304
7285 032	413	7373 300	383	7680 008	58	8100 030	293

8100 030	351	8100 706	351	8403 001	300	8410 000	301
8100 037	293	8100 707	356	8403 008	300	8411 000	301
8100 058	350	8100 708	356	8403 014	300	8415 000	301
8100 111	296	8100 709	356	8403 300	300	8416 000	301
8100 112	296	8100 710	351	8403 301	300	8424 100	312
8100 154	295	8100 712	350	8403 303	300	8424 851	88
8100 201	295	8100 714	350	8403 308	300	8424 856	34
8100 280	295	8100 715	356	8403 310	300	8424 858	54
8100 303	295	8119 000	301	8403 311	300	8424 859	72
8100 304	295	8143 000	301	8403 312	300	8425 100	316
8100 305	296	8151 000	297	8403 325	91	8426 000	314
8100 306	296	8151 001	293	8403 325	300	8426 100	314
8100 600	293	8151 003	350	8404 000	300	8426 106	35
8100 602	292	8151 004	356	8407 000	299	8435 000	301
8100 614	292	8151 006	33	8407 100	299	8435 002	301
8100 615	292	8151 008	52	8407 102	299	8435 003	301
8100 617	292	8151 009	70	8407 103	299	8441 000	328
8100 618	292	8151 100	297	8407 108	298	8441 030	328
8100 620	293	8152 100	296	8407 109	298	8442 500	333
8100 621	293	8153 100	296	8407 110	33	8443 002	334
8100 622	293	8154 043	297	8407 110	299	8449 500	333
8100 627	293	8156 000	297	8407 113	299	8458 001	332
8100 628	293	8159 101	295	8407 115	298	8466 000	324
8100 651	292	8320 000	381 / 411	8407 116	298	8466 100	324
8100 652	292	8331 000	305	8407 117	298	8467 000	320
8100 653	292	8331 012	305	8407 120	33	8467 100	320
8100 700	350	8333 000	305	8407 120	298	8471 000	338
8100 701	351	8333 012	305	8407 121	70	8477 100	313
8100 702	351	8401 000	300	8407 121	298	8478 001	337
8100 703	350	8401 001	300	8407 122	52	8480 001	320
8100 704	351	8402 000	300	8407 122	298	8481 000	332
8100 705	351	8403 000	300	8407 200	300	8483 001	323

8484 000	319	8524 008	57	8669 029	300	9700 534	373 / 461
8485 002	329	8524 009	75	8669 030	300	9700 535	373 / 461
8486 000	321	8524 100	336	8669 031	300	9700 536	373 / 461
8487 000	315	8525 000	330	8669 032	300	9700 537	373 / 461
8488 000	318	8530 000	340	8669 033	300	9700 538	373 / 461
8492 000	323	8542 655	293	8669 058	300	9700 539	373 / 461
8493 000	321	8549 000	324	8669 059	300	9700 574	373 / 461
8496 100	322	8550 000	331	8669 066	300	9700 575	373 / 461
8497 000	326	8551 000	331	8669 068	300	9700 577	373
8497 020	325	8611 000	296	8669 069	300	9700 580	373
8497 100	326	8612 000	296	8700 007	300	9700 592	469
8497 400	56	8631 300	297	8700 062	300		
8497 606	327	8633 300	297	8700 080	300		
8497 700	74	8642 000	294	8803 000	369		
8497 856	37	8642 004	294	8803 116	369		
8498 626	326	8643 117	360	8803 118	369		
8498 851	89	8644 003	294	8803 119	369		
8498 856	36	8644 044	294	9601 668	401		
8498 858	55	8644 101	295	9601 727	401		
8498 859	73	8648 002	294	9601 741	401		
8499 000	335	8657 001	294	9601 742	401		
8520 000	340	8659 111	294	9700 001	464 / 465 / 466		
8520 010	341	8660 000	300	9700 221	475		
8520 100	341	8669 000	300	9700 380	467		
8520 856	39	8669 008	300	9700 409	468		
8521 000	317	8669 009	300	9700 450	472		
8522 000	329	8669 011	300	9700 459	472 / 471		
8522 100	329	8669 012	300	9700 460	471		
8523 000	339	8669 018	300	9700 497	471		
8524 000	336	8669 019	300	9700 517	473 / 474		
8524 100	336	8669 026	300	9700 532	373 / 461		
8524 006	38	8669 028	300	9700 533	373 / 461		

Garanzie e Assistenza Foster



Foster è azienda certificata ISO 9001: 2015
Registration number CH-36474

Garanzie

Tutti i prodotti Foster sono conformi alle direttive CE e sono coperti da garanzia Foster per 24 mesi.

Assistenza

Desideriamo darvi un prodotto ed un servizio all'altezza della vostra scelta, per questo Foster è dotata di una capillare rete di Centri di Assistenza Tecnica, in Italia e all'estero.



Per richiedere assistenza:



Cerca e contatta il centro assistenza autorizzato che si occupa della tua zona



Contatta il nostro customer care compilando il modulo che trovi sul sito

Foster declina ogni responsabilità per eventuali inesattezze grafiche ed errori e si riserva il diritto di apportare modifiche e migliorie ai prodotti illustrati in qualsiasi momento senza preavviso. Ogni articolo del presente catalogo è prodotto in conformità alle normative vigenti e alle direttive CE. L'organizzazione Foster sarà lieta di fornire ulteriori dettagli ed aggiornamenti su prodotti e servizi.

Realizzato in collaborazione con DNT Comunicazione e StudioSpazian.

Foster 

Foster Spa
Via M. S. Ottone, 18/20 - 42041 Brescello (RE) Italy
info@fosterspa.com - fosterspa.com